

Arizona 1 28 (145 5/8" x 98 3/8")

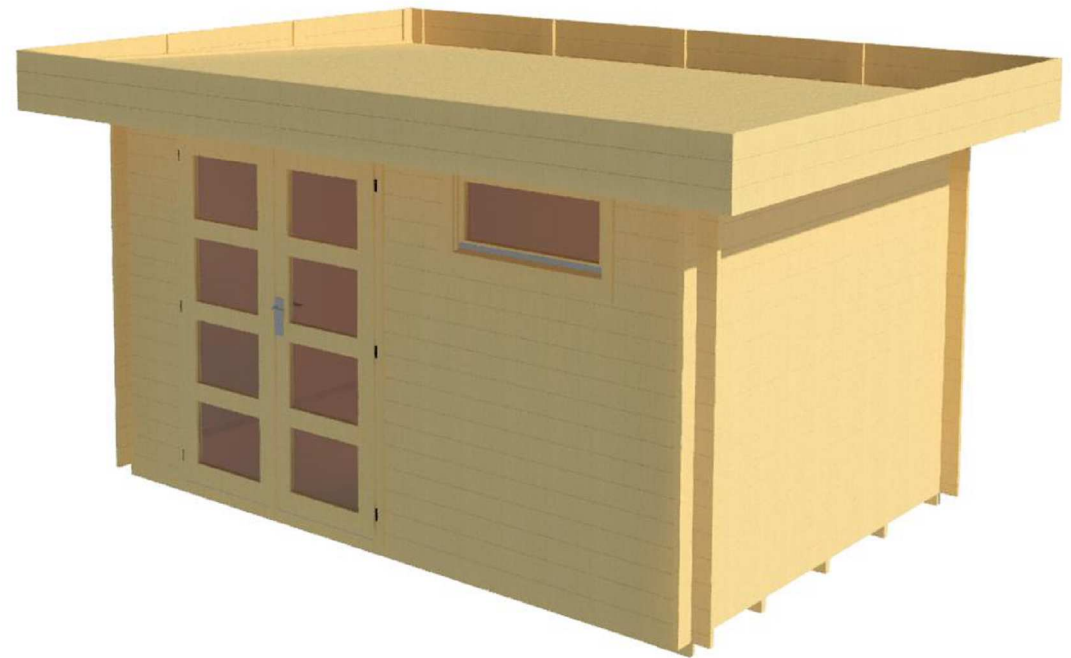
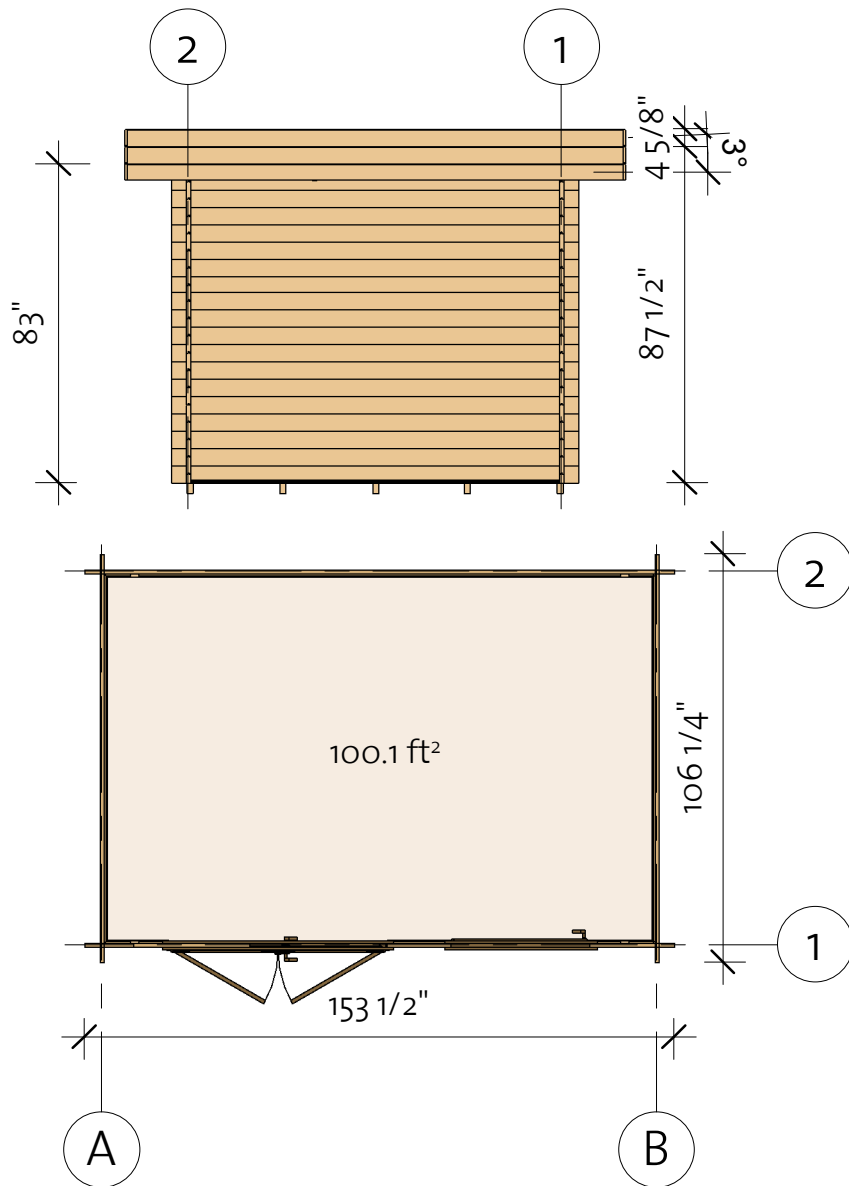

4000010_210521

 **EZ Log Structures**
Do-It-Yourself Building Kits

Arizona 1 28 (145 5/8" x 98 3/8")

Foundation

| Impregnated foundation beams | | | | |
|------------------------------|------|---------|-------|--------|
| Mark | Type | Profile | Count | Length |

| | | | | |
|-----|--------------|---|---|-------------|
| IFB | IFB 40x70 |  | 5 | 145 1/4" |
|-----|--------------|---|---|-------------|





Arizona 1 28 (145 5/8" x 98 3/8")

Floor Plan

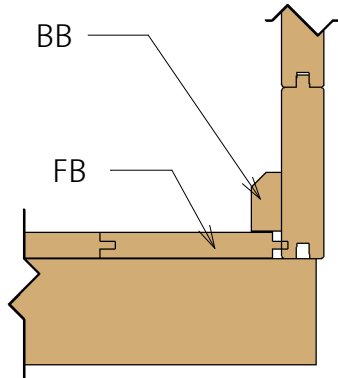
① Baseboard



| Floor Schedule | | | | |
|----------------|-----------|---|-------|----------|
| Mark | Type | Profile | Count | Length |
| FB | FB 17x114 |  | 33 | 96 1/8" |
| BB1 | BB 20x40 |  | 2 | 98 3/8" |
| BB2 | BB 20x40 | | 2 | 145 5/8" |

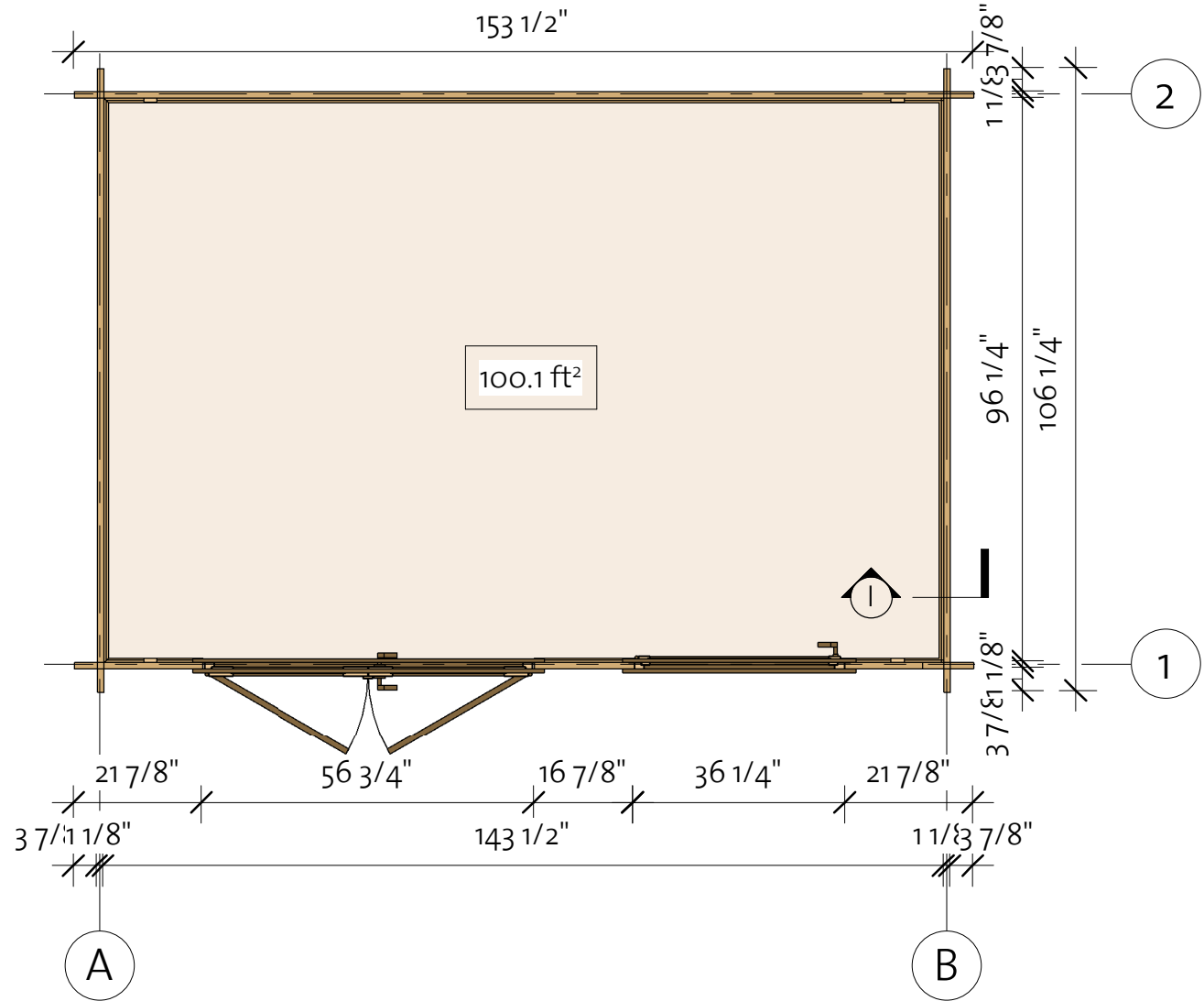

Arizona 1 28 (145 5/8" x 98 3/8")

Wall 1

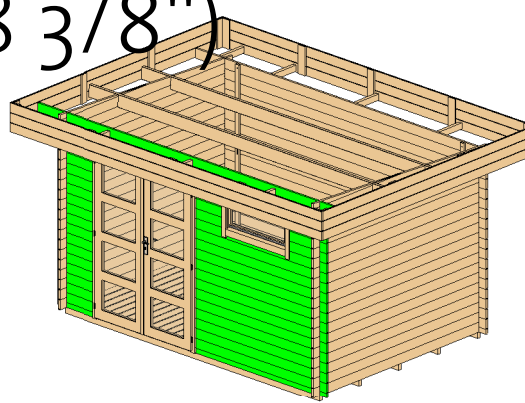

| Wall 1 | | | |
|--------|---------|-------|------------|
| Mark | Profile | Count | Cut Length |

| | | | |
|-------|--------|----|----------|
| 1BL 1 | 28x57 | 1 | 21 7/8" |
| 1BL 2 | 28x57 | 1 | 75" |
| 1LG 1 | 28x114 | 4 | 16 7/8" |
| 1LG 2 | 28x114 | 21 | 21 7/8" |
| 1LG 3 | 28x114 | 13 | 75" |
| 1LG 4 | 28x114 | 1 | 153 1/2" |
| 1TL 1 | 28x114 | 1 | 176 3/8" |

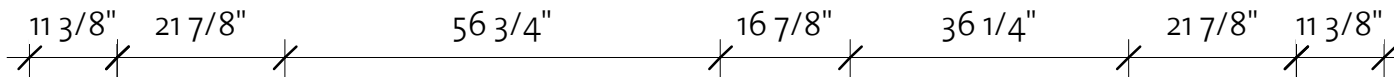
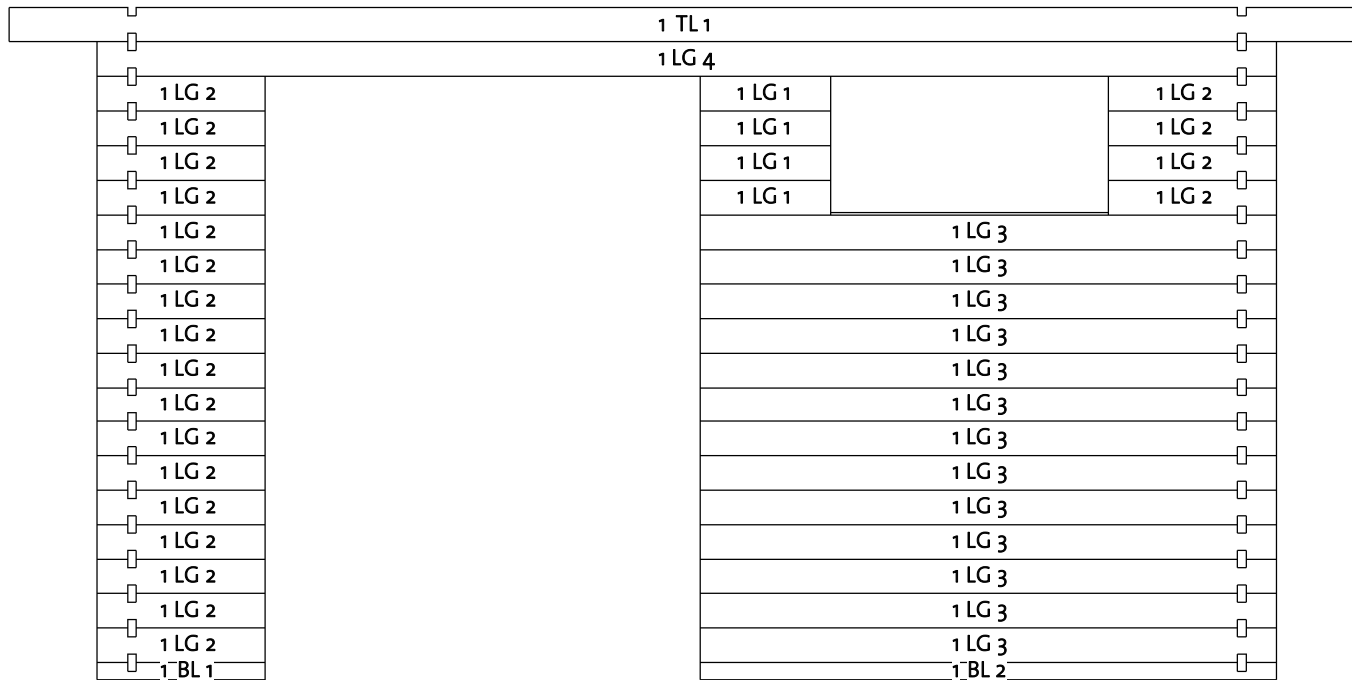

| Log Profile Wall 1 | |
|--------------------|---------|
| Profile | Profile |

| | |
|--------|--|
| 28x114 | |
| 28x57 | |
| 28x114 | |

Arizona 1 28 (145 5/8" x 98 3/8")

Wall 2

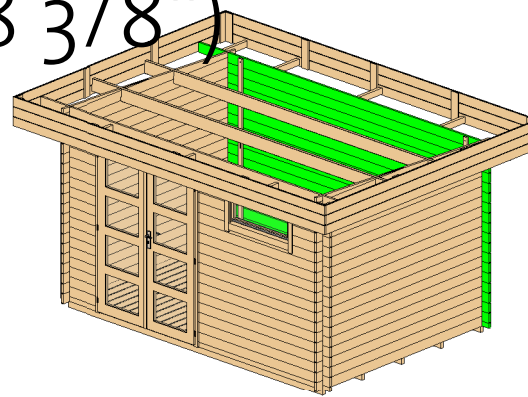

| Wall 2 | | | |
|--------|---------|-------|------------|
| Mark | Profile | Count | Cut Length |

| | | | |
|-------|--------|----|----------|
| 2BL 1 | 28x57 | 1 | 153 1/2" |
| 2LG 1 | 28x114 | 17 | 153 1/2" |
| 2TL 1 | 28x114 | 1 | 176 3/8" |

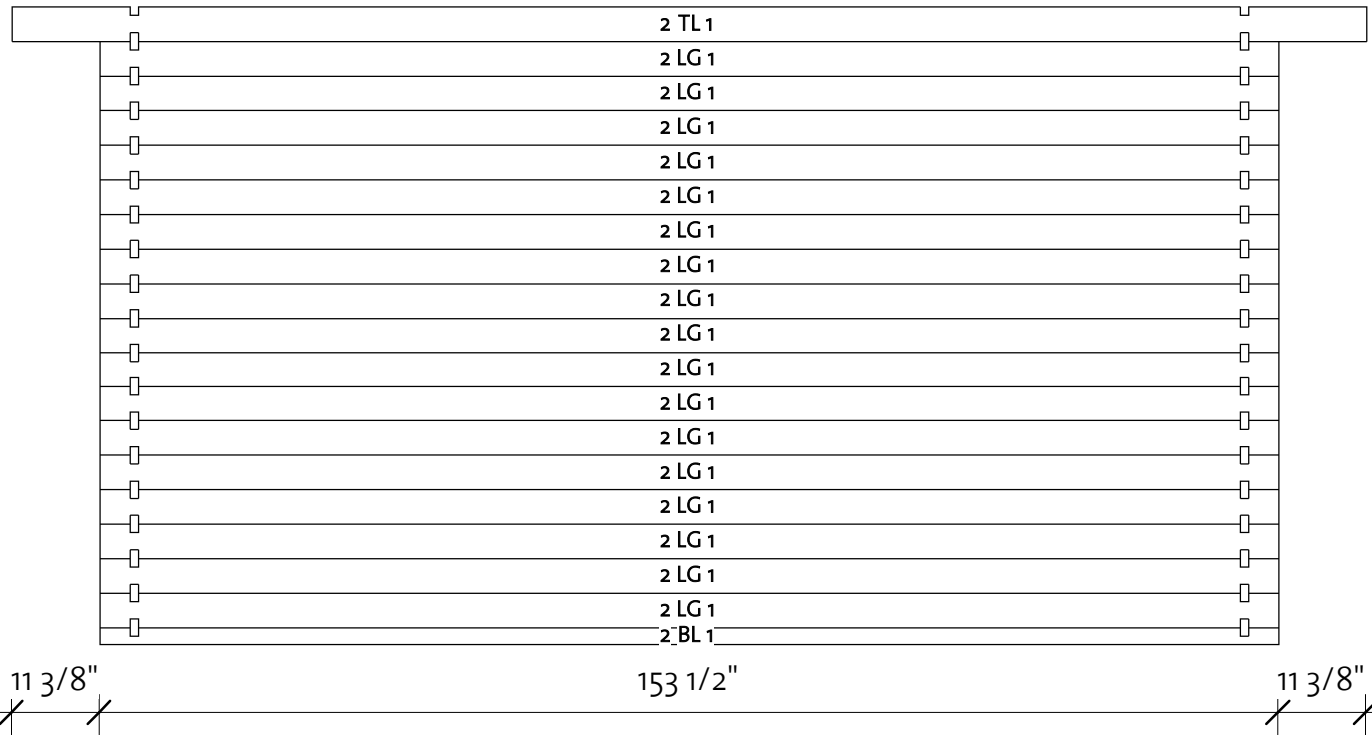

| Log Profile Wall 2 | |
|--------------------|---------|
| Profile | Profile |

| | |
|--------|--|
| 28x114 | |
| 28x57 | |
| 28x114 | |

Arizona 1 28 (145 5/8" x 98 3/8")

Wall A

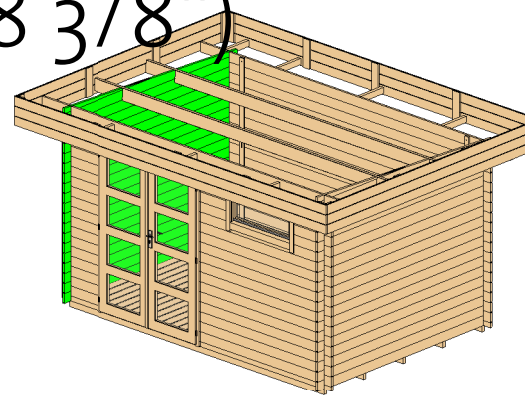

| Wall A | | | |
|--------|---------|-------|------------|
| Mark | Profile | Count | Cut Length |

| | | | |
|---------|--------|----|----------|
| ALG 1 * | 28x114 | 1 | 53 3/4" |
| ALG 2 * | 28x114 | 1 | 106 1/4" |
| ALG 3 | 28x114 | 17 | 106 1/4" |
| ALG 4 * | 28x114 | 1 | 106 1/4" |

* Gable - delivered premounted

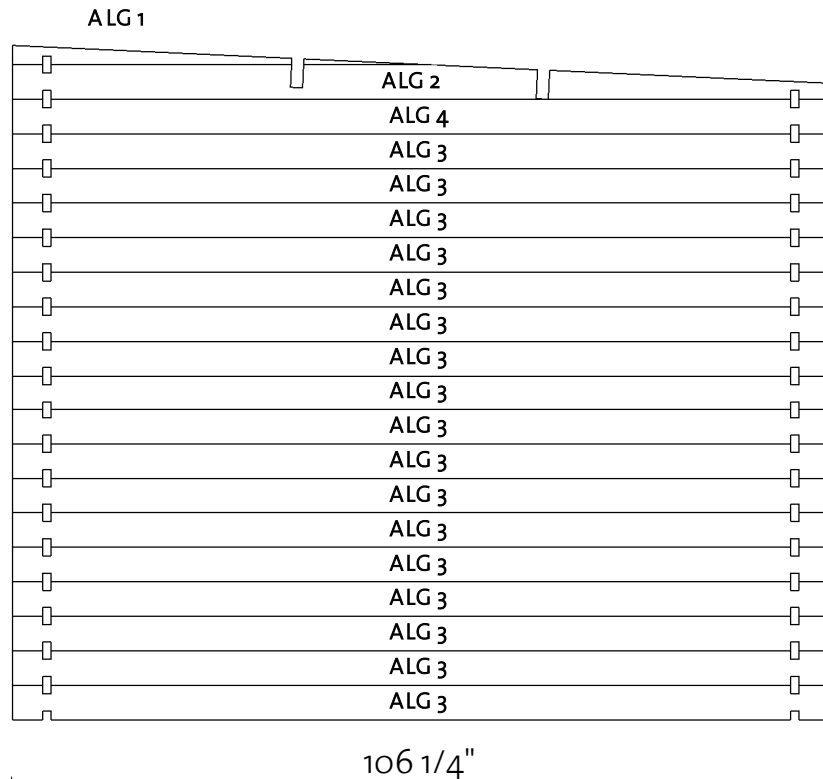

| Log Profile Wall A | |
|--------------------|---------|
| Profile | Profile |

| | |
|--------|--|
| 28x114 | |
| 28x114 | |

Arizona 1 28 (145 5/8" x 98 3/8")

Wall B

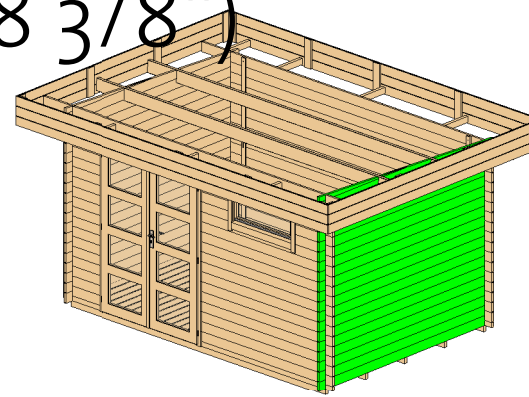

| Wall B | | | |
|--------|---------|-------|------------|
| Mark | Profile | Count | Cut Length |

| | | | |
|---------|--------|----|----------|
| BLG 1 * | 28x114 | 1 | 53 3/4" |
| BLG 2 * | 28x114 | 1 | 106 1/4" |
| BLG 3 | 28x114 | 17 | 106 1/4" |
| BLG 4 * | 28x114 | 1 | 106 1/4" |

* Gable - delivered premounted

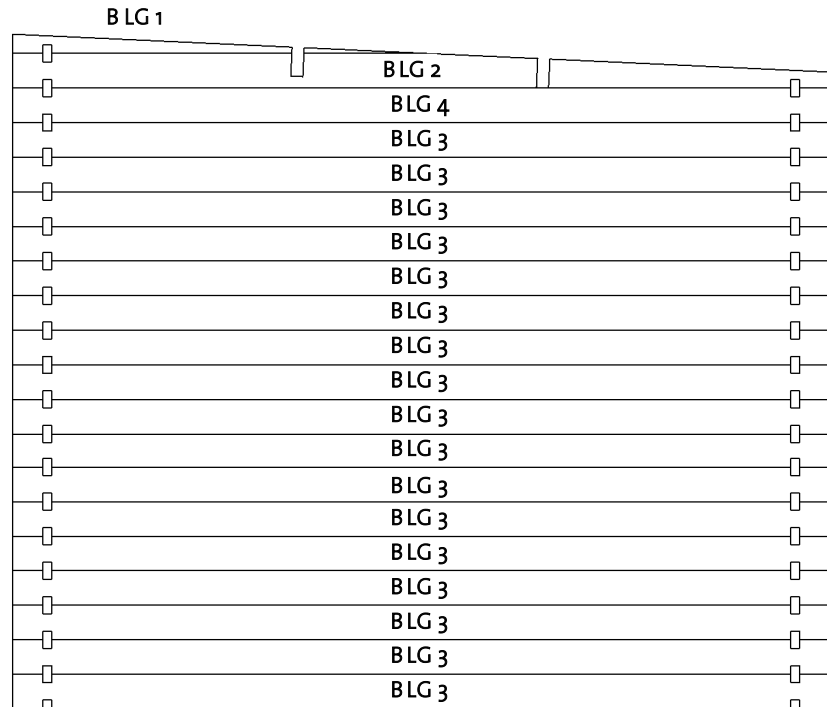

106 1/4"

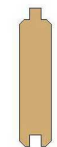

| Log Profile Wall B | |
|--------------------|---------|
| Profile | Profile |

28x114



Arizona 1 28 (145 5/8" x 98 3/8")

Roof 1

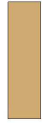
| Roof | | | | |
|------|----------------|---|-------|----------|
| Mark | Type | Profile | Count | Length |
| RB | 17x114 |  | 40 | 127 1/8" |
| RE1 | 40x70 |  | 8 | 15 3/8" |
| RFB | Beam 40x143 |  | 2 | 176 3/8" |

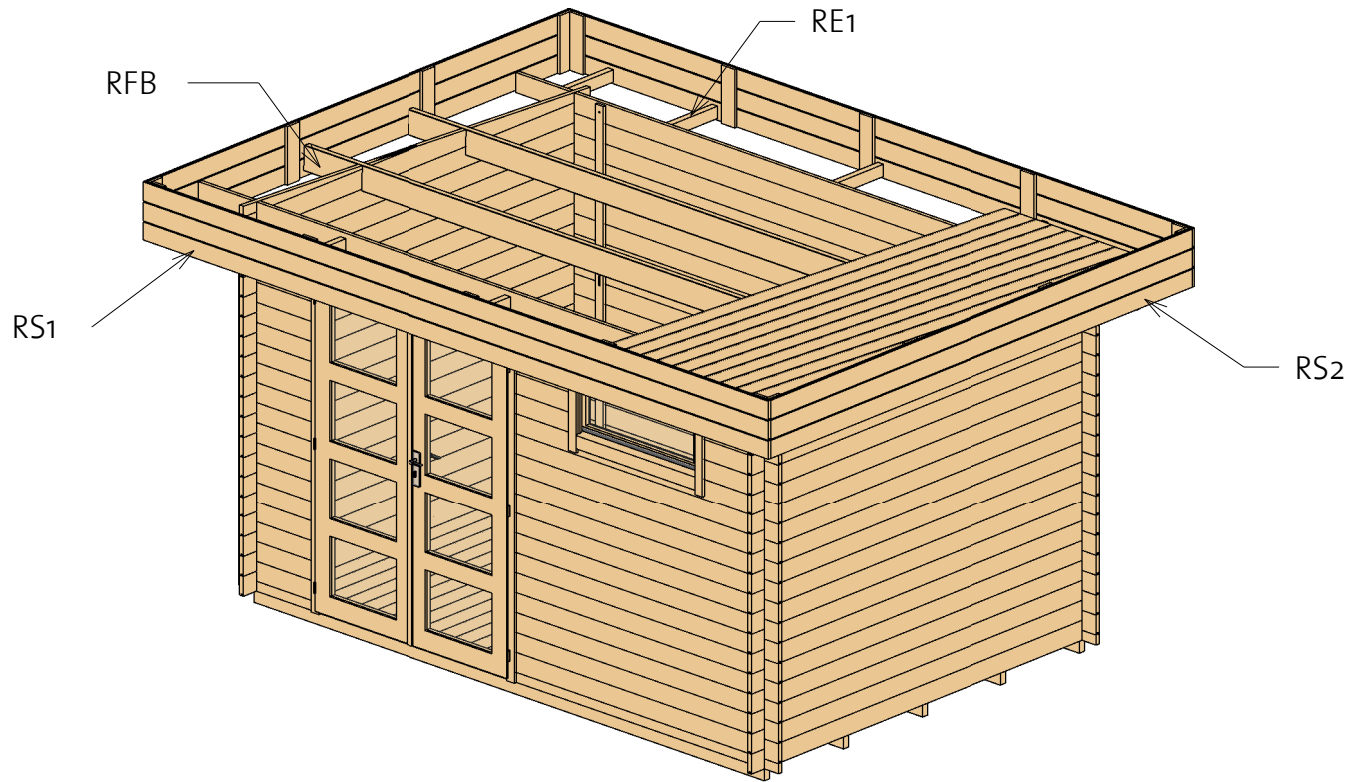

| Roof Side Schedule | | |
|--------------------|----------|-------|
| Type | Length | Count |
| RS1 | 177 3/4" | 2 |
| RS2 | 129 1/8" | 2 |

Arizona 1 28 (145 5/8" x 98 3/8")

Roof 2

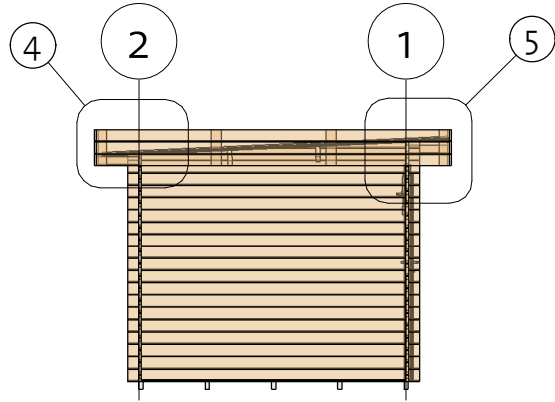

| Fascia Schedule | | | | |
|-----------------|-------------------|---------|-------|----------|
| Mark | Type | Profile | Count | Length |
| EE1 | Eave Edging 18x40 | | 1 | 175" |
| EE2 | Eave Edging 18x40 | | 2 | 124 7/8" |

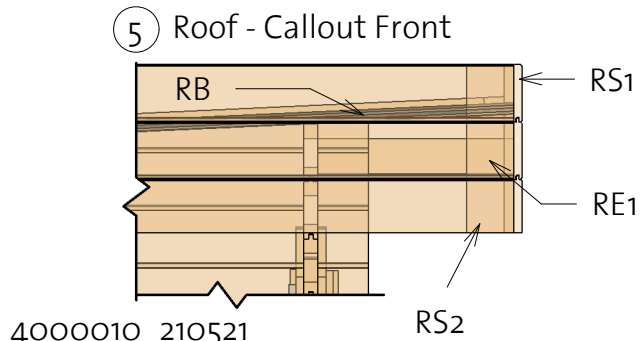
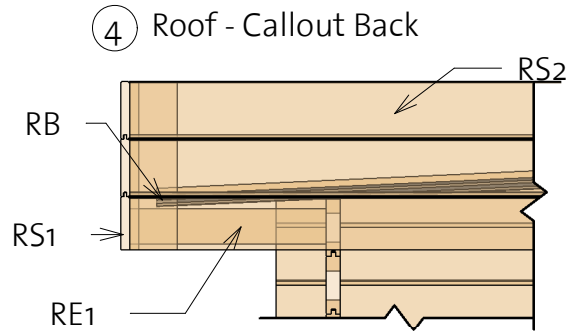

4000010_210521

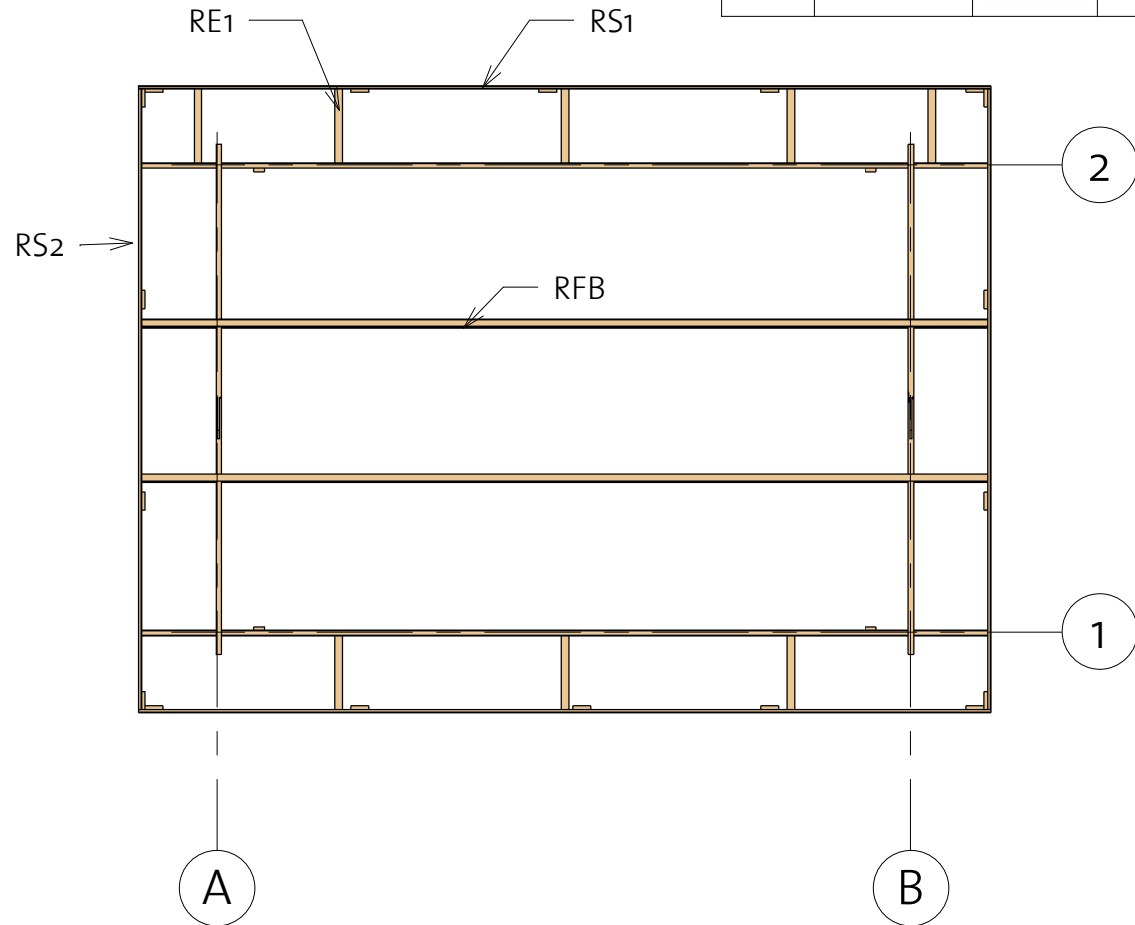

Arizona 1 28 (145 5/8" x 98 3/8")

Extras

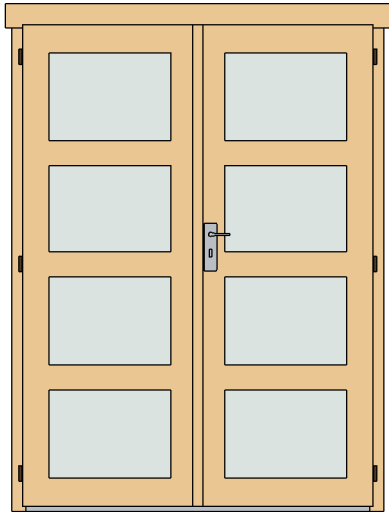

| Door Schedule | | | | |
|---------------|------|-------|--------|-------|
| Model | Type | Width | Height | Count |

| | | | | |
|-------|---------------------------------------|---------|-----|---|
| BDD4R | Basic double door 4, four glass right | 56 1/8" | 77" | 1 |
|-------|---------------------------------------|---------|-----|---|

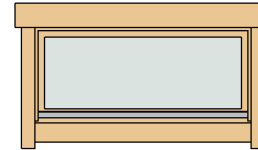

| Window Schedule | | | | |
|-----------------|------|-------|--------|-------|
| Model | Type | Width | Height | Count |

| | | | | |
|------|----------------------|-----|---------|---|
| BW2R | Basic window 2 right | 36" | 16 1/2" | 1 |
|------|----------------------|-----|---------|---|

| | | | | |
|------|----------------------------|----|----|---|
| WCB6 | Window crossbar 6 optional | -- | -- | 1 |
|------|----------------------------|----|----|---|

| Fasteners & Extras | | |
|--------------------|----------|-------|
| Name | Comments | Count |

| | | |
|----------|------------|-----|
| Hitblock | 300-400 mm | |
| Bolts | M8 x 60 | 12 |
| Screws | 5,0 x 70 | 25 |
| Nails | 1,4 x 40 | 30 |
| Screws | 6,0 x 140 | 80 |
| Screws | 4,0x40 | 400 |



| Type | Count | Length |
|------|-------|--------|
|------|-------|--------|

| | | |
|-----------------|---|---------|
| Windboard 18x40 | 4 | 86 5/8" |
|-----------------|---|---------|

Arizona 1 28 (145 5/8"x98 3/8")

List of all items 1



Impregnated foundation beams

| Mark | Type | Profile | Count | Length |
|------|------|---------|-------|--------|
|------|------|---------|-------|--------|

| | | | | |
|-----|--------------|---|---|-------------|
| IFB | IFB 40x70 |  | 5 | 145 1/4" |
|-----|--------------|---|---|-------------|

Roof

| Mark | Type | Profile | Count | Length |
|------|------|---------|-------|--------|
|------|------|---------|-------|--------|

| | | | | |
|-----|----------------|---|----|-------------|
| RB | 17x114 |  | 40 | 127 1/8" |
| RE1 | 40x70 |  | 8 | 15 3/8" |
| RFB | Beam 40x143 |  | 2 | 176 3/8" |

Floor Schedule



| Mark | Type | Profile | Count | Length |
|------|------|---------|-------|--------|
|------|------|---------|-------|--------|

| | | | | |
|----|-----------|---|----|---------|
| FB | FB 17x114 |  | 33 | 96 1/8" |
|----|-----------|---|----|---------|

| | | | | |
|-----|-------------|---|---|-------------|
| BB1 | BB 20x40 |  | 2 | 98 3/8" |
| BB2 | BB 20x40 | | 2 | 145 5/8" |

Fascia Schedule

| Mark | Type | Profile | Count | Length |
|------|------|---------|-------|--------|
|------|------|---------|-------|--------|

| | | | | |
|-----|-------------------------|---|---|-------------|
| EE1 | Eave Edging 18x40 |  | 1 | 175" |
| EE2 | Eave Edging 18x40 |  | 2 | 124 7/8" |

Roof Side Schedule

| Type | Length | Count |
|------|--------|-------|
|------|--------|-------|

| | | |
|-----|----------|---|
| RS1 | 177 3/4" | 2 |
| RS2 | 129 1/8" | 2 |

Arizona 1 28 (145 5/8"x98 3/8")

List of all items 2

| Wall 1 | | | |
|--------|---------|-------|------------|
| Mark | Profile | Count | Cut Length |

| | | | |
|-------|--------|----|----------|
| 1BL 1 | 28x57 | 1 | 21 7/8" |
| 1BL 2 | 28x57 | 1 | 75" |
| 1LG 1 | 28x114 | 4 | 16 7/8" |
| 1LG 2 | 28x114 | 21 | 21 7/8" |
| 1LG 3 | 28x114 | 13 | 75" |
| 1LG 4 | 28x114 | 1 | 153 1/2" |
| 1TL 1 | 28x114 | 1 | 176 3/8" |

| Wall A | | | |
|--------|---------|-------|------------|
| Mark | Profile | Count | Cut Length |

| | | | |
|---------|--------|----|----------|
| ALG 1 * | 28x114 | 1 | 53 3/4" |
| ALG 2 * | 28x114 | 1 | 106 1/4" |
| ALG 3 | 28x114 | 17 | 106 1/4" |
| ALG 4 * | 28x114 | 1 | 106 1/4" |

| Wall 2 | | | |
|--------|---------|-------|------------|
| Mark | Profile | Count | Cut Length |



| | | | |
|-------|--------|----|----------|
| 2BL 1 | 28x57 | 1 | 153 1/2" |
| 2LG 1 | 28x114 | 17 | 153 1/2" |
| 2TL 1 | 28x114 | 1 | 176 3/8" |

| Wall B | | | |
|--------|---------|-------|------------|
| Mark | Profile | Count | Cut Length |

| | | | |
|---------|--------|----|----------|
| BLG 1 * | 28x114 | 1 | 53 3/4" |
| BLG 2 * | 28x114 | 1 | 106 1/4" |
| BLG 3 | 28x114 | 17 | 106 1/4" |
| BLG 4 * | 28x114 | 1 | 106 1/4" |

* Gable - delivered premounted

| Log Profiles | |
|--------------|---------|
| Profile | Profile |

| | |
|--------|---|
| 28x114 |  |
| 28x57 |  |
| 28x114 |  |