

# Billings 160 40 (151 1/8" x 151 1/8")

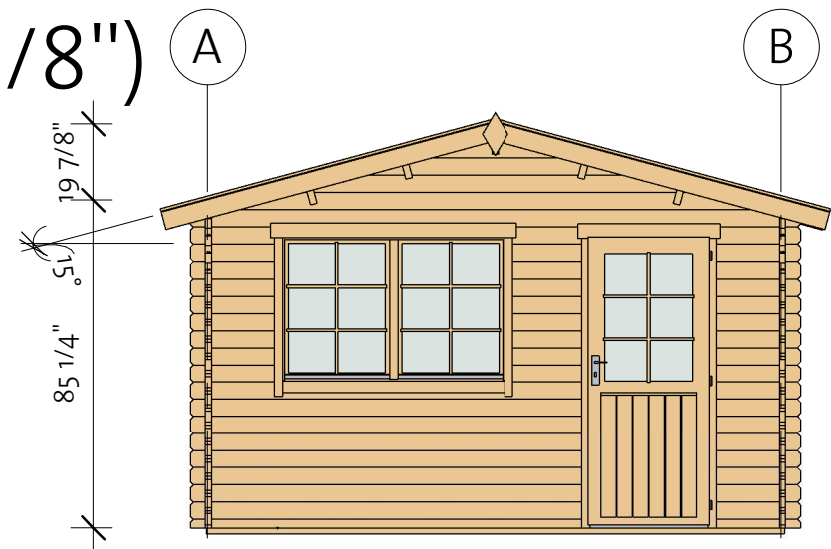

# Billings 160 40 (151 1/8" x 151 1/8")

Foundation

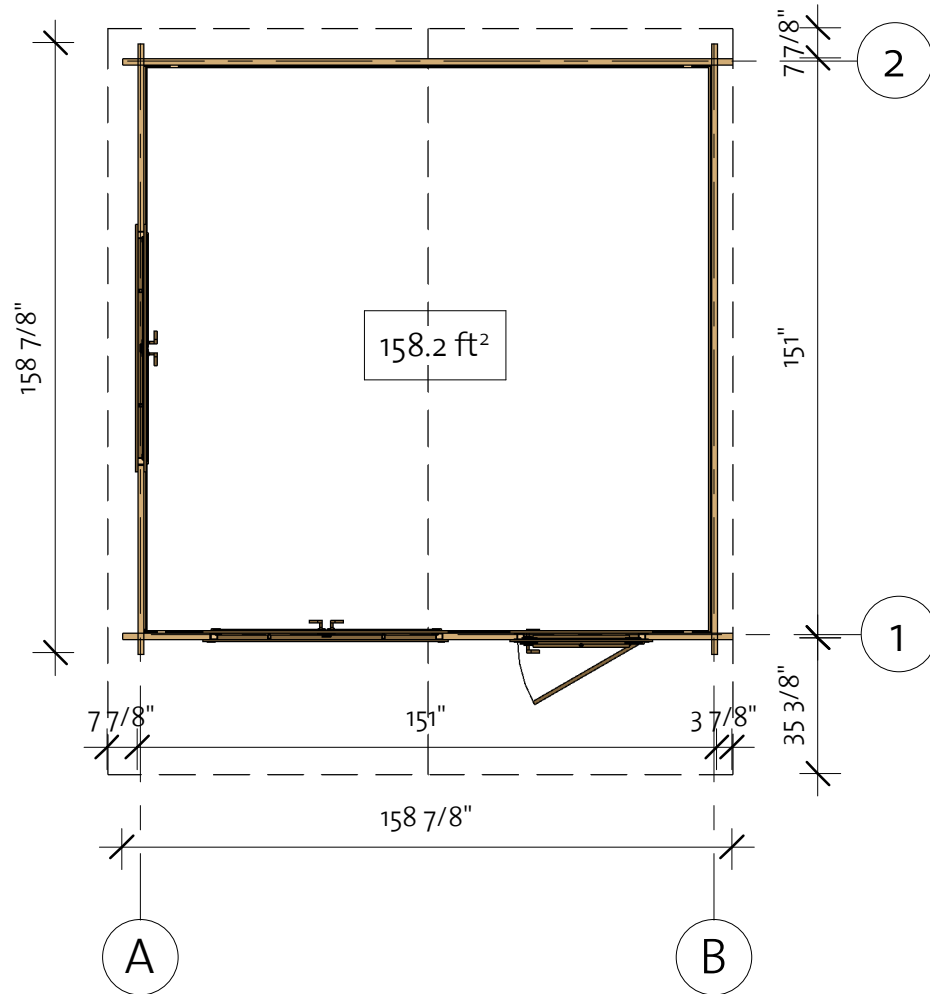
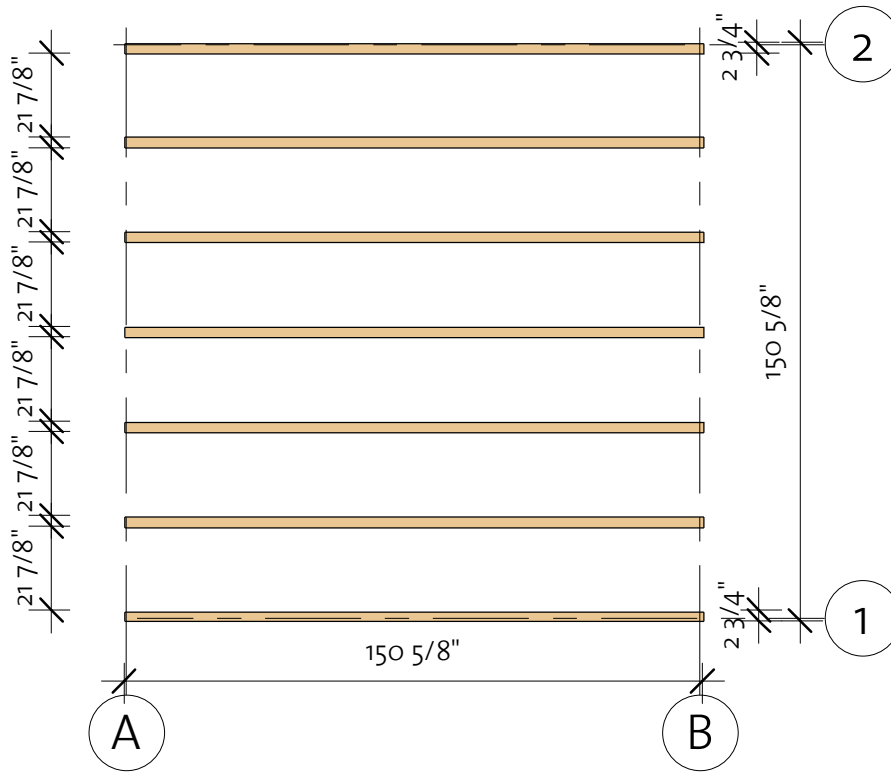

Impregnated foundation beams				
Mark	Type	Profile	Count	Length

IFB	IFB 70x40		7	150 5/8"
-----	--------------	---	---	-------------



# Billings 160 40 (151 1/8" x 151 1/8")

Floor Plan

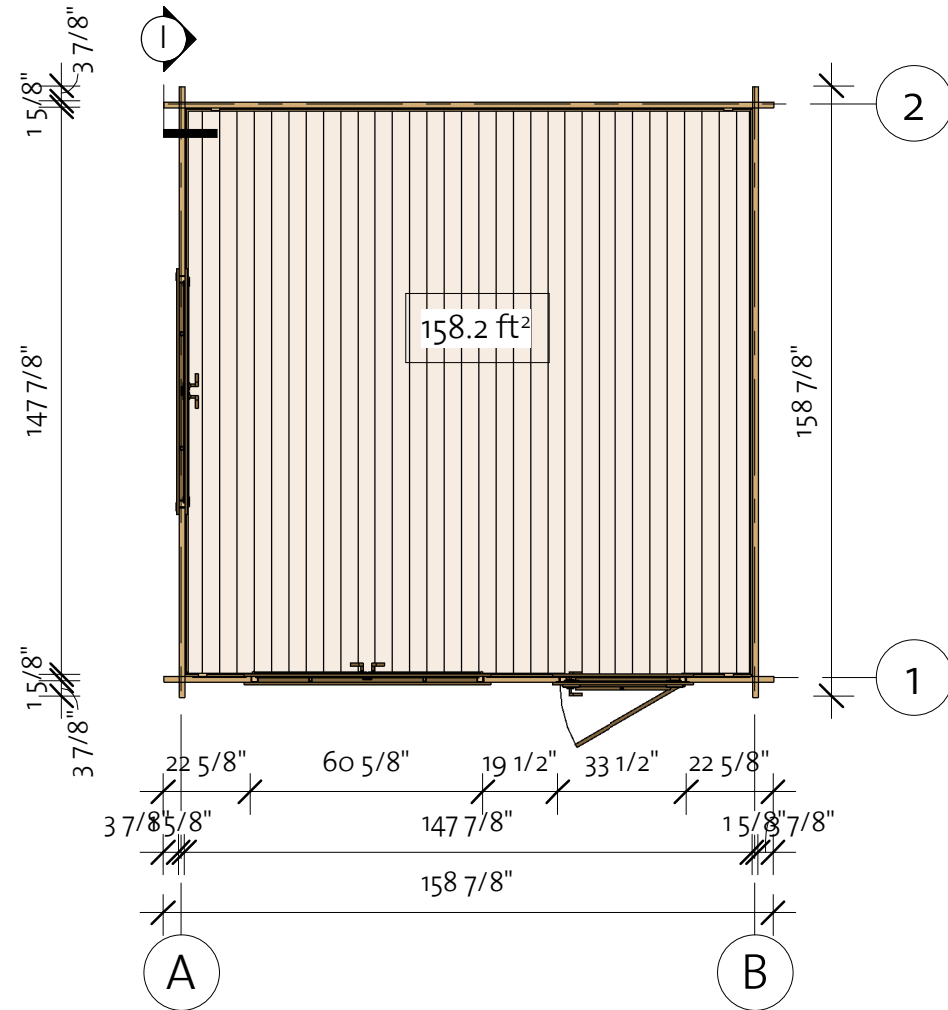
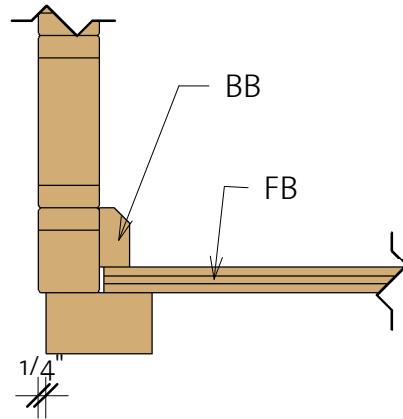
① Baseboard



Floor Schedule

Mark	Type	Profile	Count	Length
FB	FB 17x114		34	147 5/8"
BB1	BB 20x40		4	153 1/2"

# Billings 160 40 (151 1/8" x 151 1/8")

Wall 1

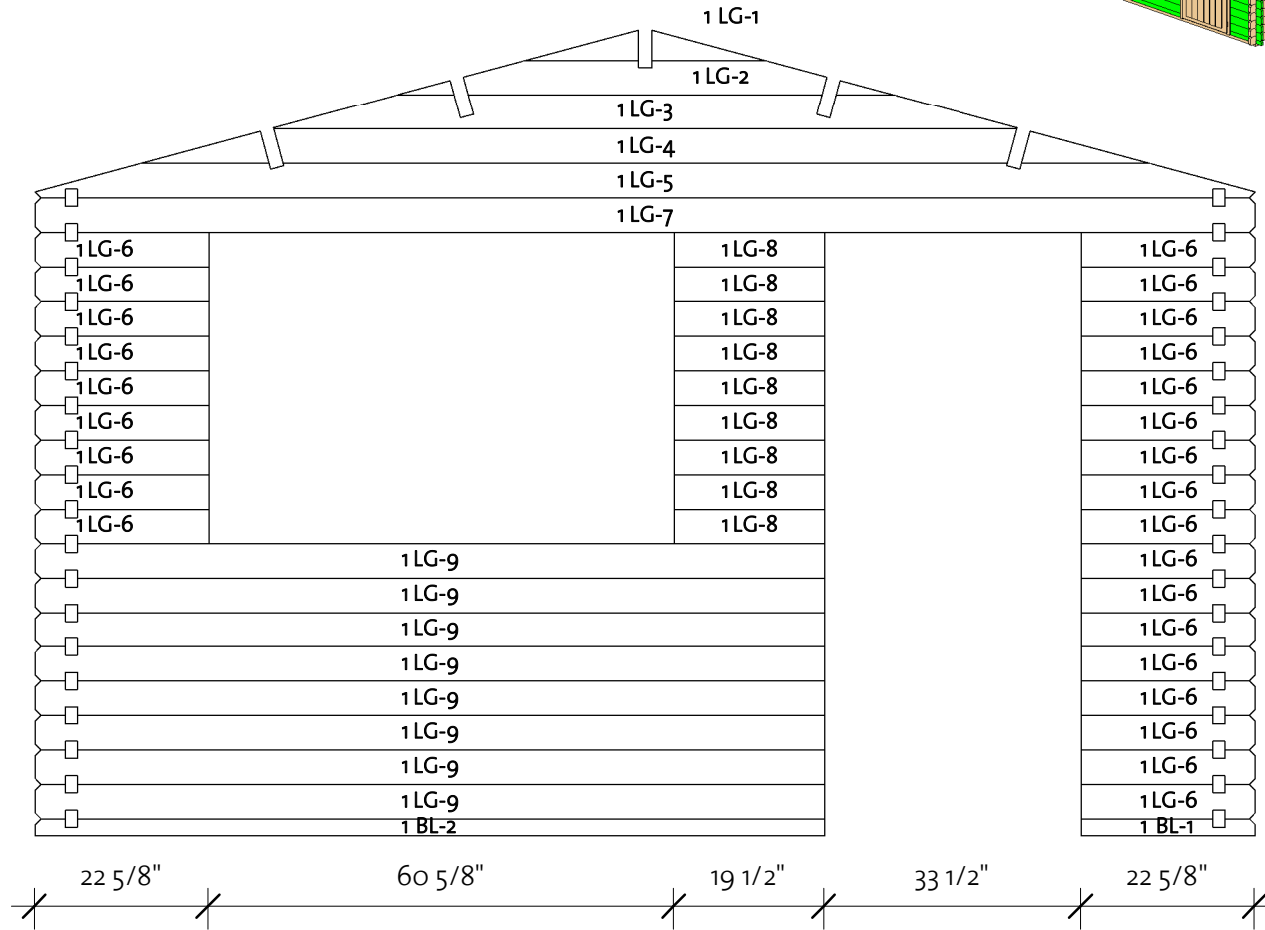
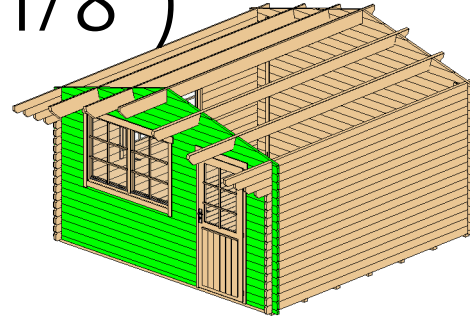

Wall 1			
Mark	Profile	Count	Cut Length

1BL-1	40X57	1	22 5/8"
1BL-2	40X57	1	102 3/4"
1LG-1 *	40X114	1	31 3/8"
1LG-2 *	40X114	1	64 5/8"
1LG-3 *	40X114	1	96 7/8"
1LG-4 *	40X114	1	131 1/4"
1LG-5 *	40X114	1	158 7/8"
1LG-6	40X114	26	22 5/8"
1LG-7	40X114	1	158 7/8"
1LG-8	40X114	9	19 1/2"
1LG-9	40X114	8	102 3/4"

\* Gable - delivered premounted

Log Profile Wall 1	
Profile	Profile

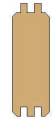
40X57	
40X114	

# Billings 160 40 (151 1/8" x 151 1/8")

Wall 2

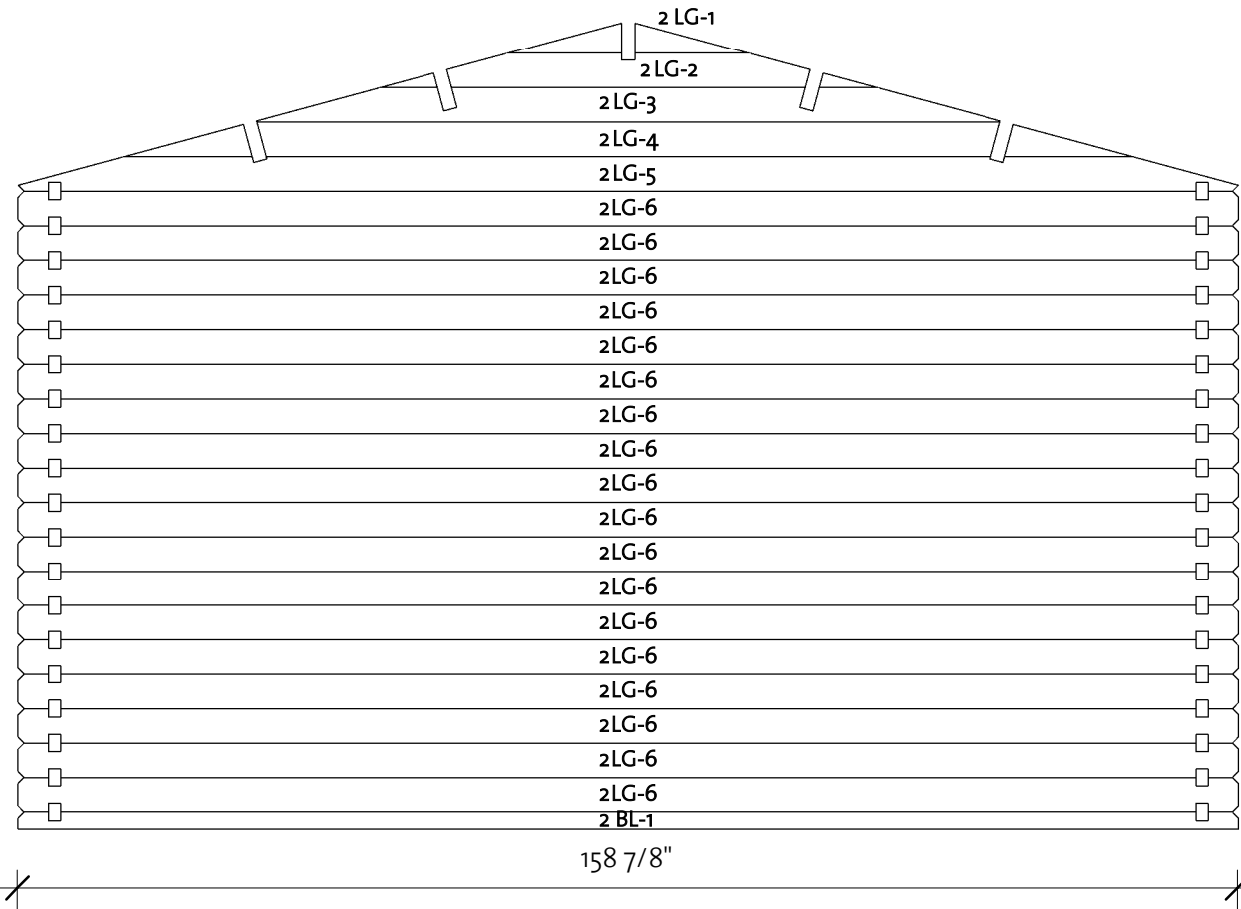
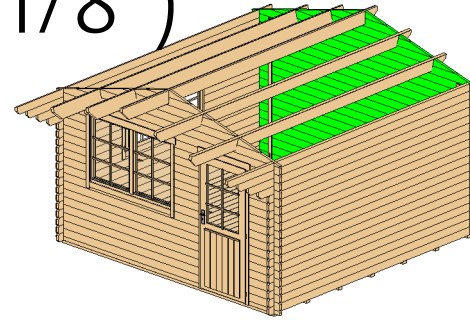



Wall 2			
Mark	Profile	Count	Cut Length

2BL-1	40X57	1	158 7/8"
2LG-1*	40X114	1	31 3/8"
2LG-2*	40X114	1	64 5/8"
2LG-3*	40X114	1	96 7/8"
2LG-4*	40X114	1	131 1/4"
2LG-5*	40X114	1	158 7/8"
2LG-6	40X114	18	158 7/8"

\* Gable - delivered premounted

Log Profile Wall 2	
Profile	Profile

40X57	
40X114	

# Billings 160 40 (151 1/8" x 151 1/8")

Wall A

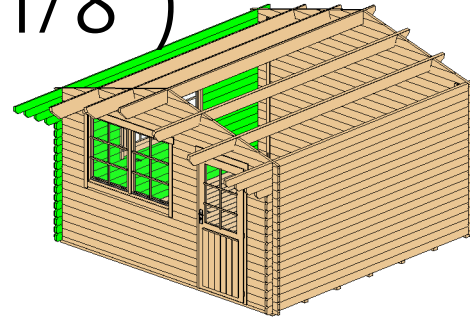

Wall A			
Mark	Profile	Count	Cut Length

ALG-1	4OX114	8	158 7/8"
ALG-2	4OX114	1	57"
ALG-3	4OX114	1	64 7/8"
ALG-4	4OX114	1	182 1/2"
ALG-5	4OX114	16	49 1/8"
ATL-1	4OX114	1	194 3/8"

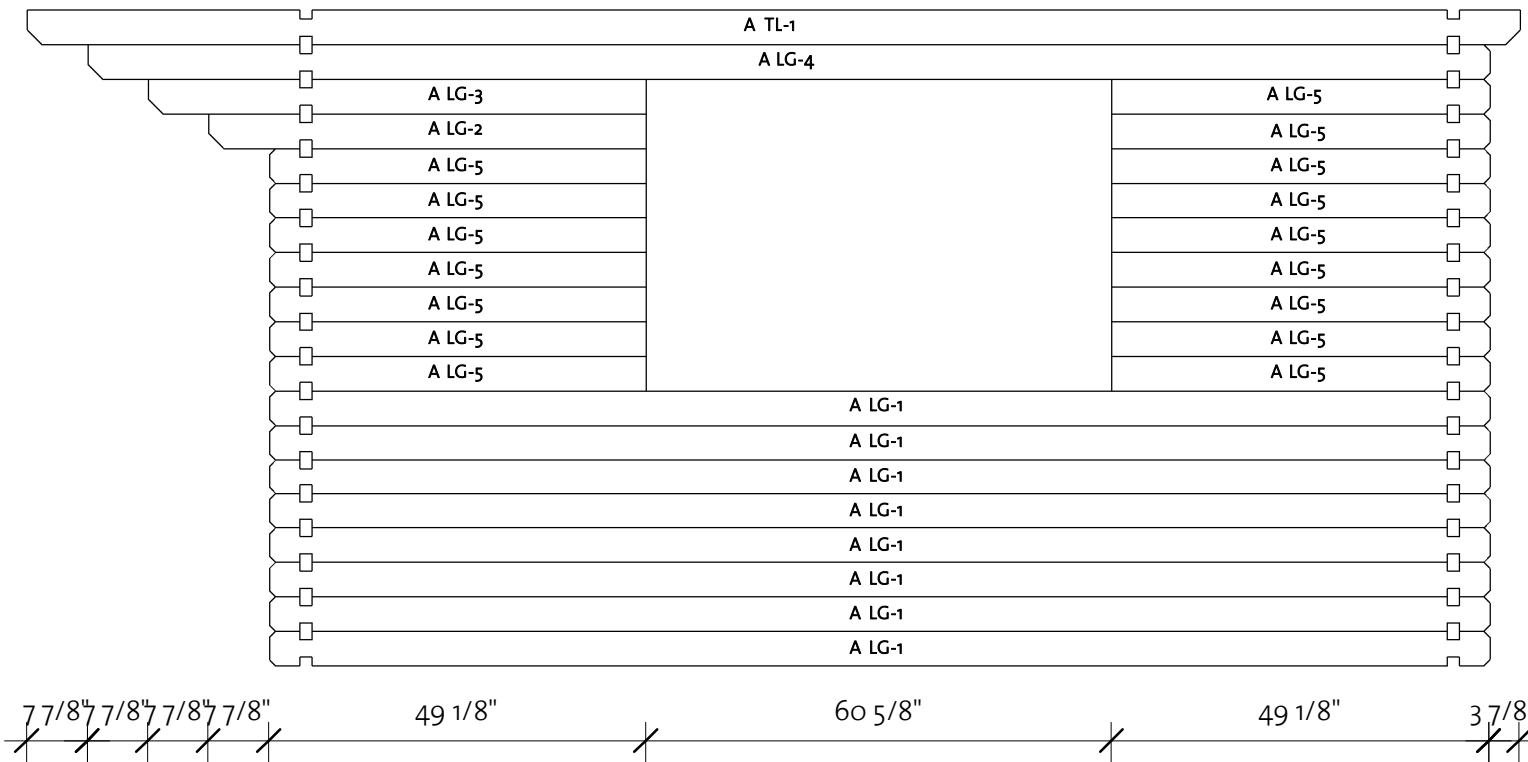

Log Profile Wall A	
Profile	Profile

4OX114	
4OX114	

# Billings 160 40 (151 1/8" x 151 1/8")

Wall B

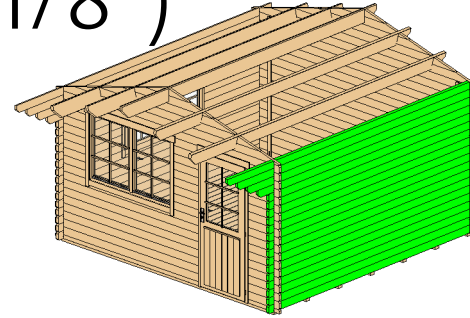

Wall B			
Mark	Profile	Count	Cut Length

BLG-1	40X114	15	158 7/8"
BLG-2	40X114	1	166 3/4"
BLG-3	40X114	1	174 5/8"
BLG-4	40X114	1	182 1/2"
BTL-1	40X114	1	194 3/8"

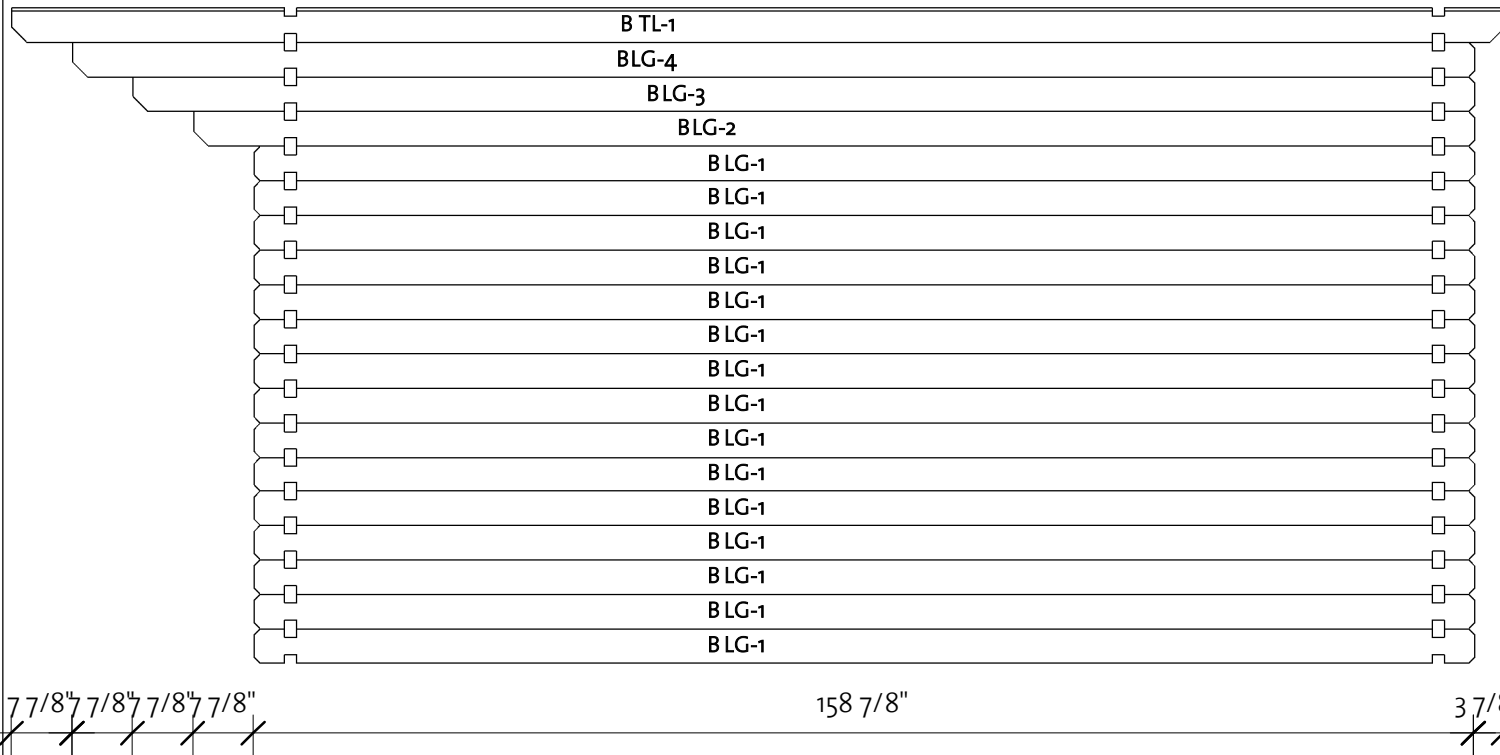





Log Profile Wall B	
Profile	Profile

40X114	
40X114	

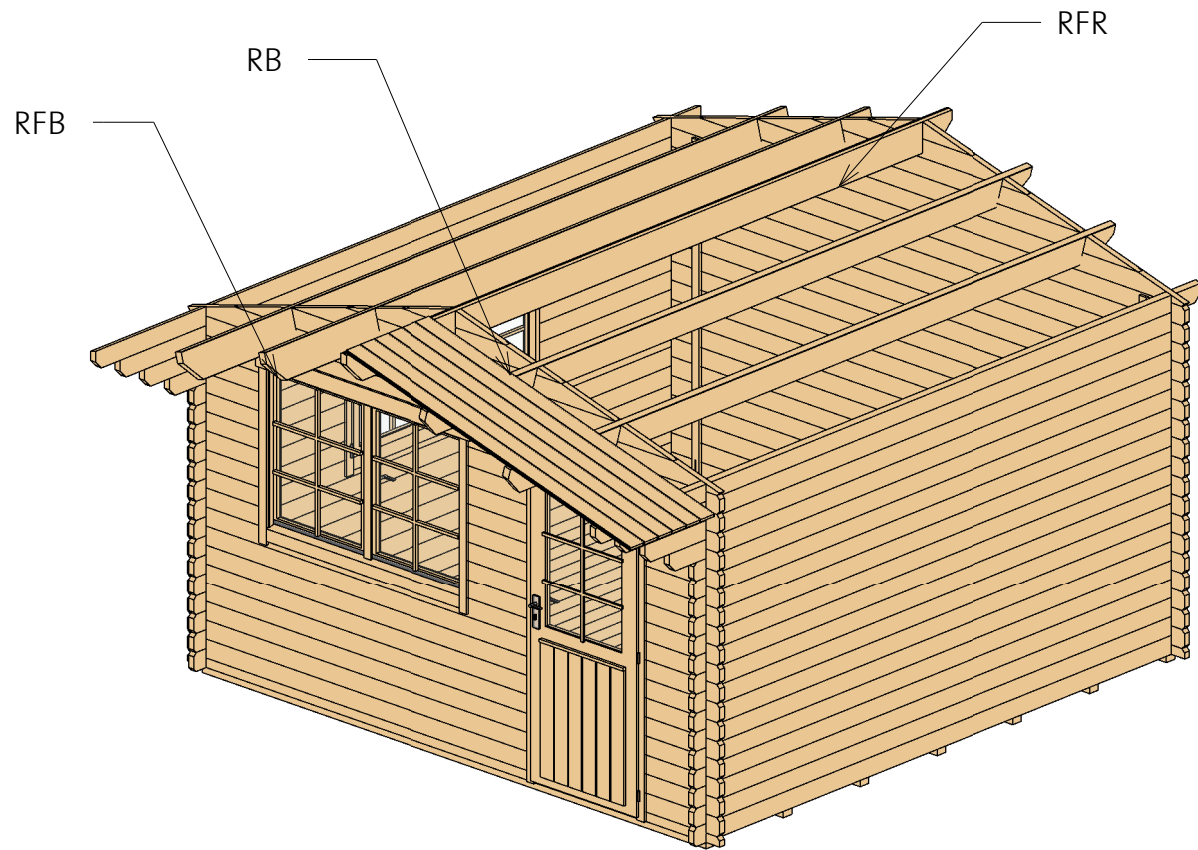
# Billings 160 40 (151 1/8" x 151 1/8")

Roof 1



Roof				
Mark	Type	Profile	Count	Length
RFR	Ridge 45x195		1	194 3/8"
RFB	Beam 45x195		4	194 3/8"
RB	17x114		88	88 1/4"



# Billings 160 40 (151 1/8" x 151 1/8")

Roof 2

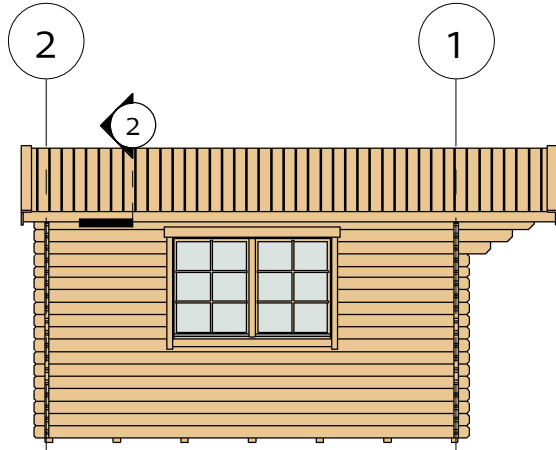

② Facia

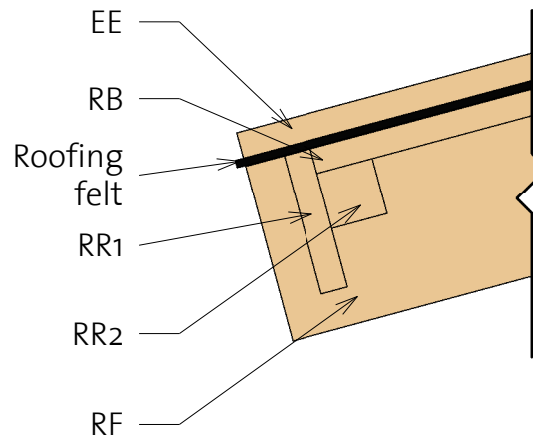

③ Roof Reinforcement

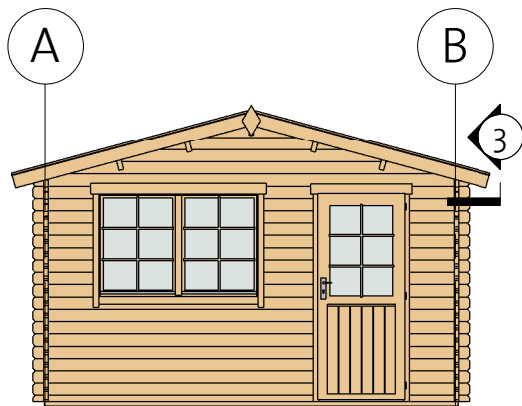
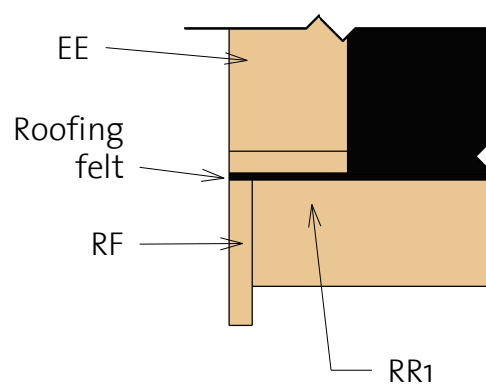

Fascia Schedule				
Mark	Type	Profile	Count	Length

EE	Eave Edging 18x95		4	90 1/8"
RF	Roof Fascia 18x120		4	90 1/8"
RR1	Roof reinforcement 18x95		2	194 3/8"
RR2	Roof reinforcement 38x38		2	194 3/8"

# Billings 160 40 (151 1/8" x 151 1/8")

Extras

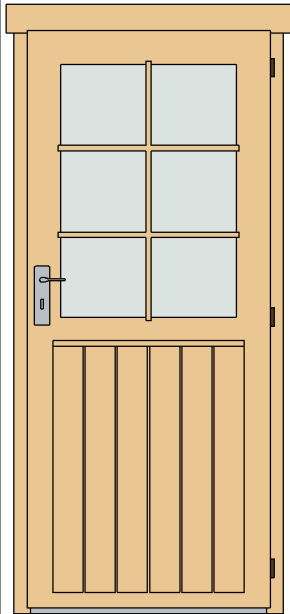

Door Schedule				
Mark	Type	Width	Height	Count
CD4R	Classic door 4 right	33 1/8"	77"	1
DCB6	Door Crossbar 6	--	--	0"

Window Schedule				
Mark	Type	Width	Height	Count
CDW1	Classic double window 1	60 1/4"	39"	2
WCB6	Windows Crossbar 6	--	--	4

Fasteners & Extras		
Name	Type	Count

Hitblock	300-400 mm	
Bolts	M8x70	12
Screws	5,0 x 70	15
Nails	1,4 x 40	35
Screws	6,0 x 140	40
Screws	4,0 x 40	700

Family	Count
Romb	2

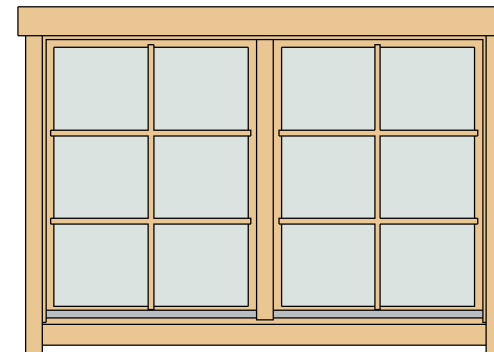

Type	Count	Length
Windboard 18x40	4	86 5/8"



# Billings 160 40 (151 1/8"x151 1/8")

## List of all items 1

Impregnated foundation beams				
Mark	Type	Profile	Count	Length

IFB	IFB 70x40		7	150 5/8"
-----	--------------	---	---	-------------

Floor Schedule				
Mark	Type	Profile	Count	Length

FB	FB 17x114		34	147 5/8"
----	-----------	---	----	-------------

BB1	BB 20x40		4	153 1/2"
-----	-------------	---	---	----------

Roof				
Mark	Type	Profile	Count	Length

RFR	Ridge 45x195		1	194 3/8"
-----	-----------------	---	---	-------------

RFB	Beam 45x195		4	194 3/8"
-----	----------------	---	---	-------------

RB	17x114		88	88 1/4"
----	--------	---	----	---------

Fascia Schedule				
Mark	Type	Profile	Count	Length

EE	Eave Edging 18x95		4	90 1/8"
----	----------------------	---	---	---------

RF	Roof Fascia 18x120		4	90 1/8"
----	-----------------------	---	---	---------

RR1	Roof reinforcement 18x95		2	194 3/8"
-----	--------------------------------	---	---	-------------

RR2	Roof reinforcement 38x38		2	194 3/8"
-----	--------------------------------	---	---	-------------

# Billings 160 40 (151 1/8" x 151 1/8")

## List of all items 2

Wall 1			
Mark	Profile	Count	Cut Length

1BL-1	40X57	1	22 5/8"
1BL-2	40X57	1	102 3/4"
1LG-1 *	40X114	1	31 3/8"
1LG-2 *	40X114	1	64 5/8"
1LG-3 *	40X114	1	96 7/8"
1LG-4 *	40X114	1	131 1/4"
1LG-5 *	40X114	1	158 7/8"
1LG-6	40X114	26	22 5/8"
1LG-7	40X114	1	158 7/8"
1LG-8	40X114	9	19 1/2"
1LG-9	40X114	8	102 3/4"

Wall 2			
Mark	Profile	Count	Cut Length

2BL-1	40X57	1	158 7/8"
2LG-1 *	40X114	1	31 3/8"
2LG-2 *	40X114	1	64 5/8"
2LG-3 *	40X114	1	96 7/8"
2LG-4 *	40X114	1	131 1/4"
2LG-5 *	40X114	1	158 7/8"
2LG-6	40X114	18	158 7/8"

\* Gable - delivered premounted



Wall A			
Mark	Profile	Count	Cut Length

ALG-1	40X114	8	158 7/8"
ALG-2	40X114	1	57"
ALG-3	40X114	1	64 7/8"
ALG-4	40X114	1	182 1/2"
ALG-5	40X114	16	49 1/8"
ATL-1	40X114	1	194 3/8"

Wall B			
Mark	Profile	Count	Cut Length

BLG-1	40X114	15	158 7/8"
BLG-2	40X114	1	166 3/4"
BLG-3	40X114	1	174 5/8"
BLG-4	40X114	1	182 1/2"
BTL-1	40X114	1	194 3/8"

Log Profiles1	
Profile	Profile

40X57	
40X114	

Log Profiles1	
Profile	Profile

40X114	
--------	---