

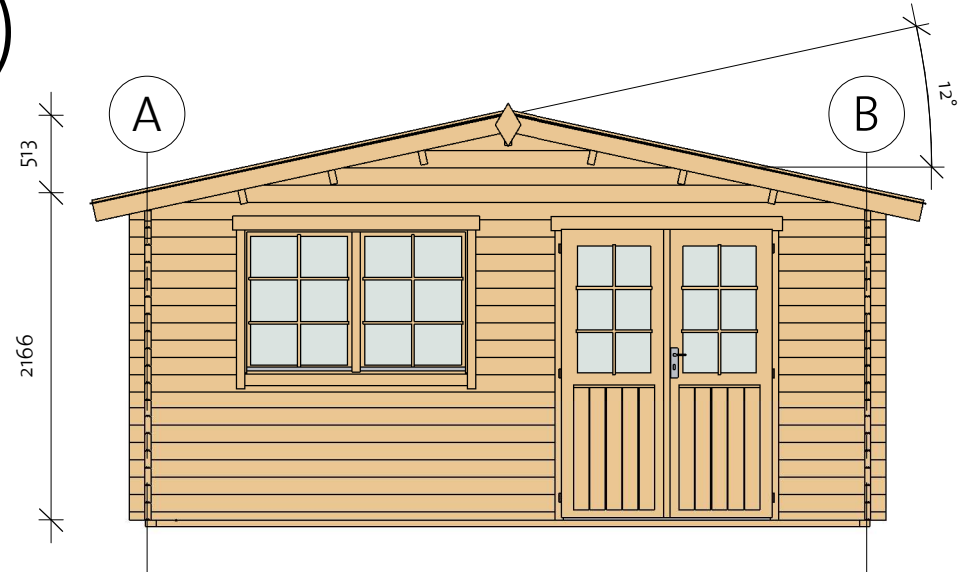

Brunswick EZ 40 (480x480)

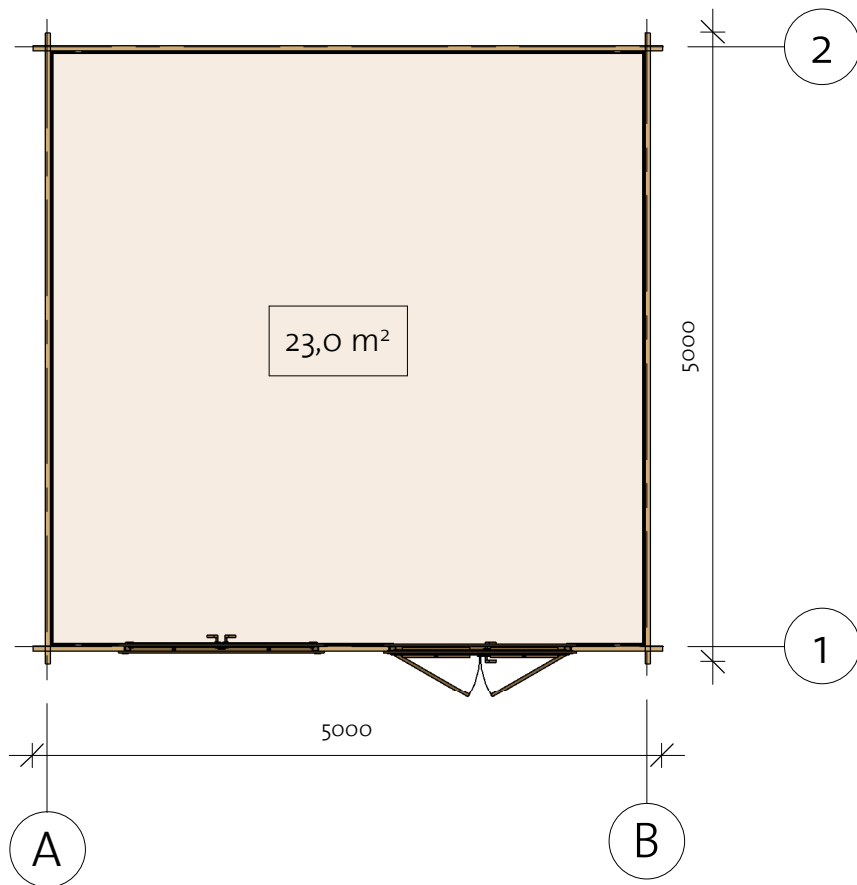
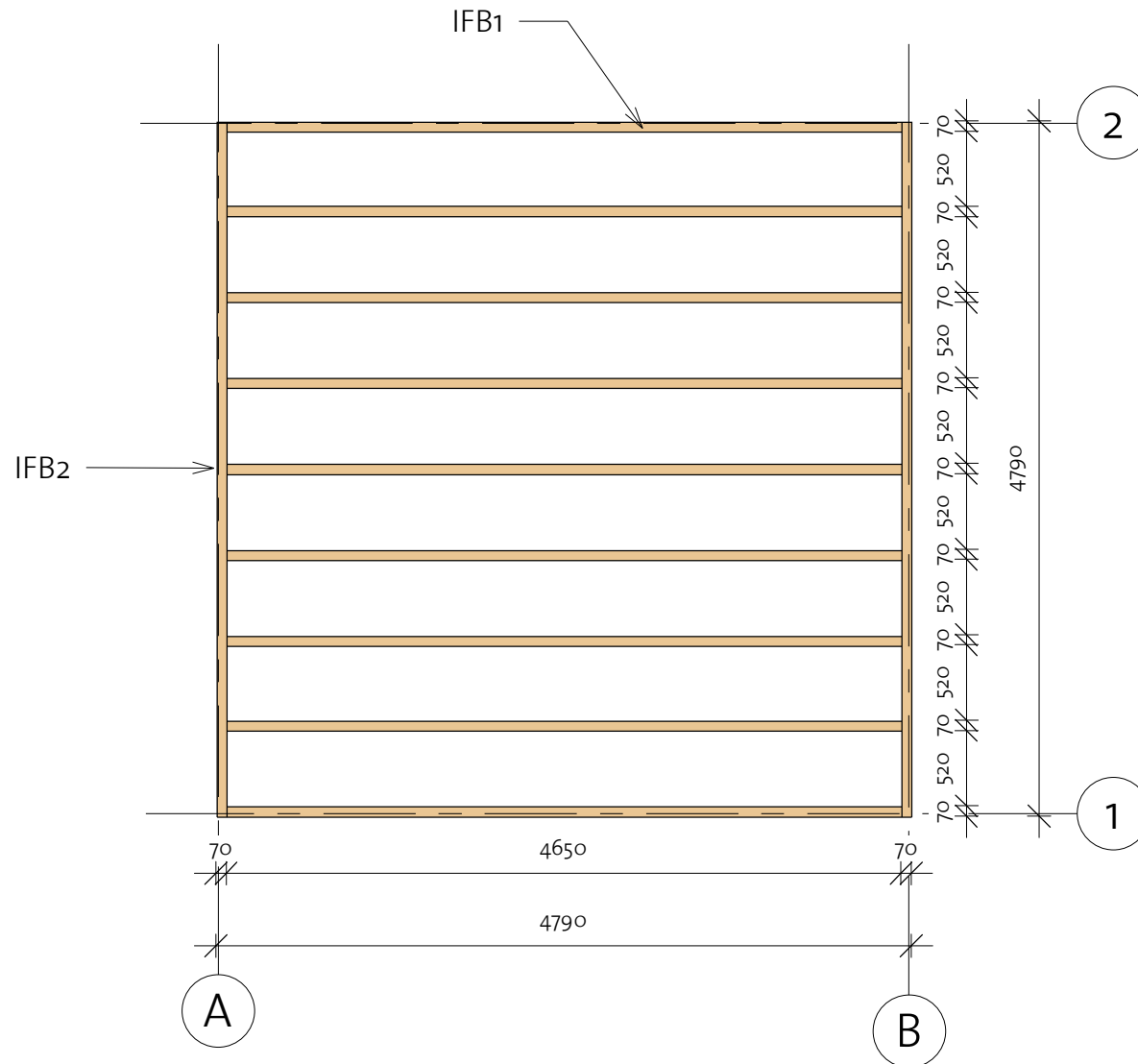

Brunswick EZ 40 (480x480)

Foundation



Impregnated foundation beams				
Mark	Type	Profile	Count	Length
IFB1	IFB 70x40		9	4650
IFB2	IFB 70x40		2	4790

Brunswick EZ 40 (480x480)

Floor Plan

① Baseboard

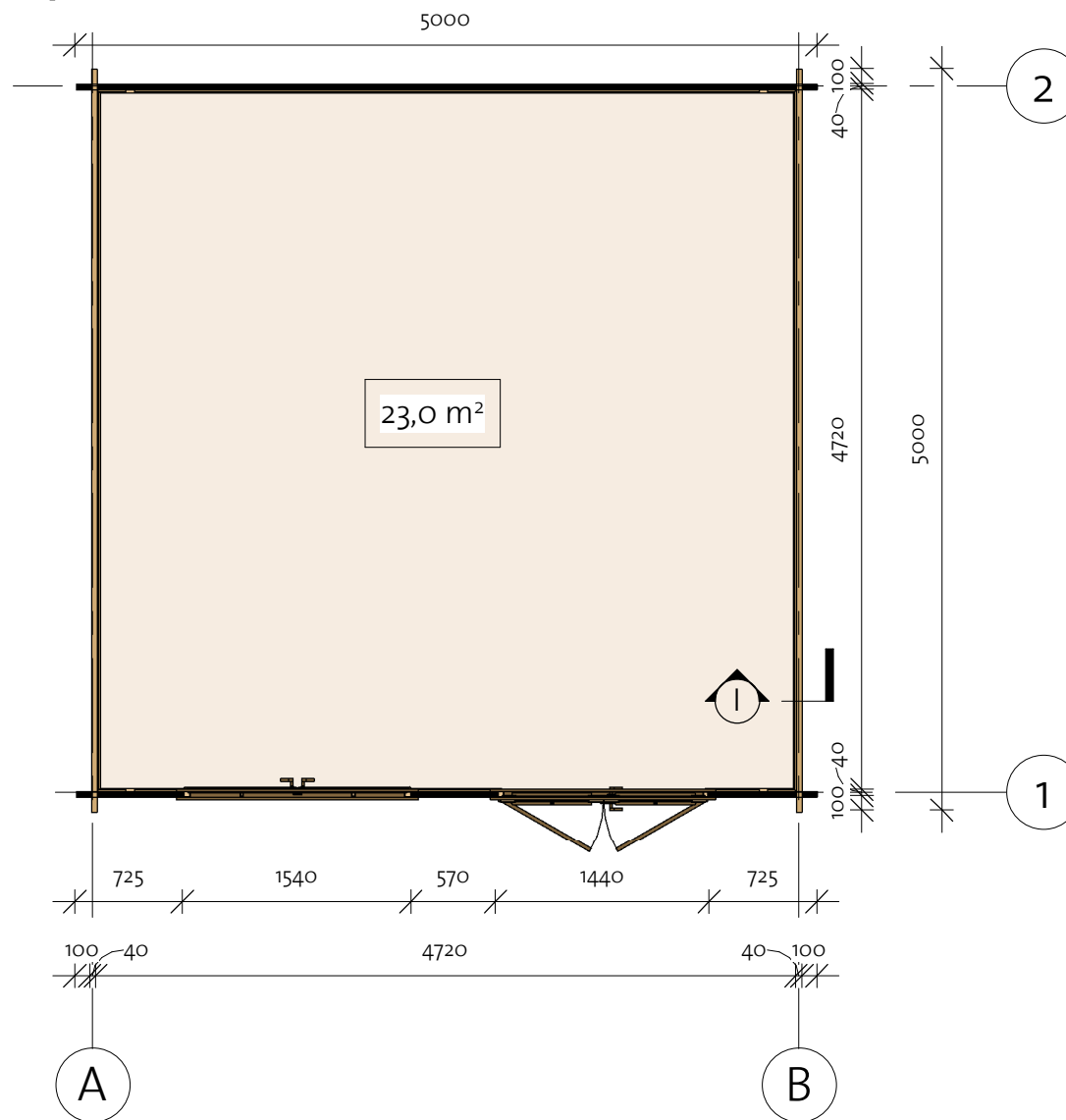
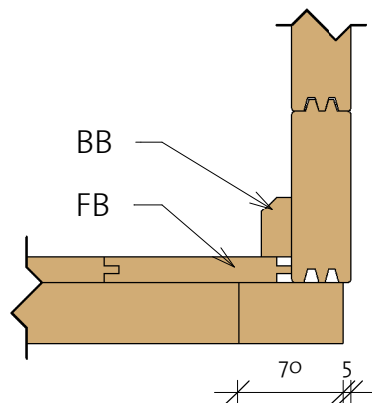

Floor Schedule

Mark	Type	Profile	Count	Length
------	------	---------	-------	--------

FB	FB 17x114		43	4714
----	-----------	--	----	------

BB	BB 20x40		4	4800
----	----------	--	---	------

92311101_231114

Brunswick EZ 40 (480x480)

Wall 1

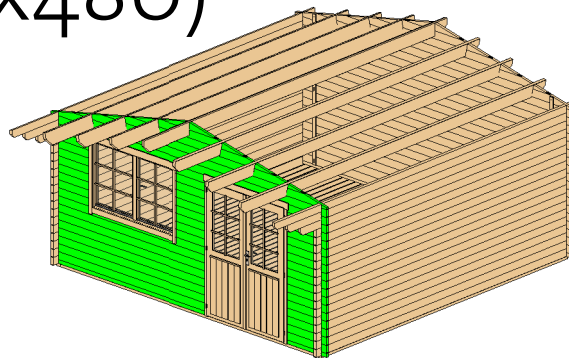

Wall 1			
Mark	Profile	Count	Cut Length

1BL-1	40X57	1	725
1BL-2	40X57	1	2835
1LG-1	40X114	9	570
1LG-2	40X114	26	725
1LG-3*	40X114	1	1050
1LG-4*	40X114	1	2099
1LG-5*	40X114	1	3147
1LG-6*	40X114	1	4196
1LG-7	40X114	8	2835
1LG-8*	40X114	1	5000
1LG-9	40X114	1	5000

* Gable - delivered premounted

Log Profile Wall 1	
Profile	Profile

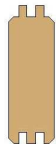
40X57	
40X114	

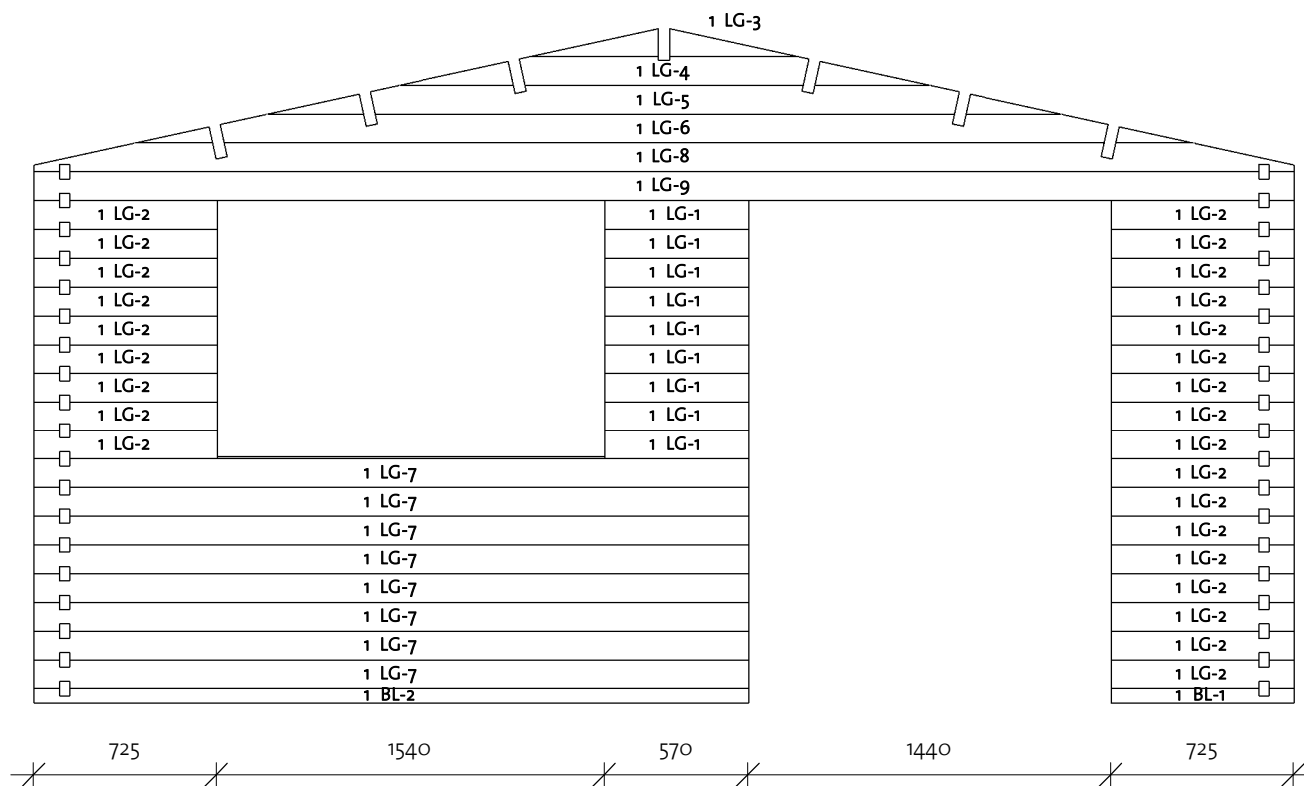

Brunswick EZ 40 (480x480)

Wall 2

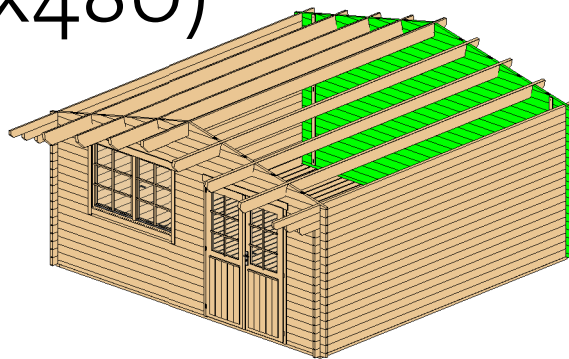

Wall 2			
Mark	Profile	Count	Cut Length

2BL-1	40x57	1	5000
2LG-1*	40x114	1	1050
2LG-2*	40x114	1	2099
2LG-3*	40x114	1	3147
2LG-4*	40x114	1	4196
2LG-5*	40x114	1	5000
2LG-6	40x114	18	5000

* Gable - delivered premounted

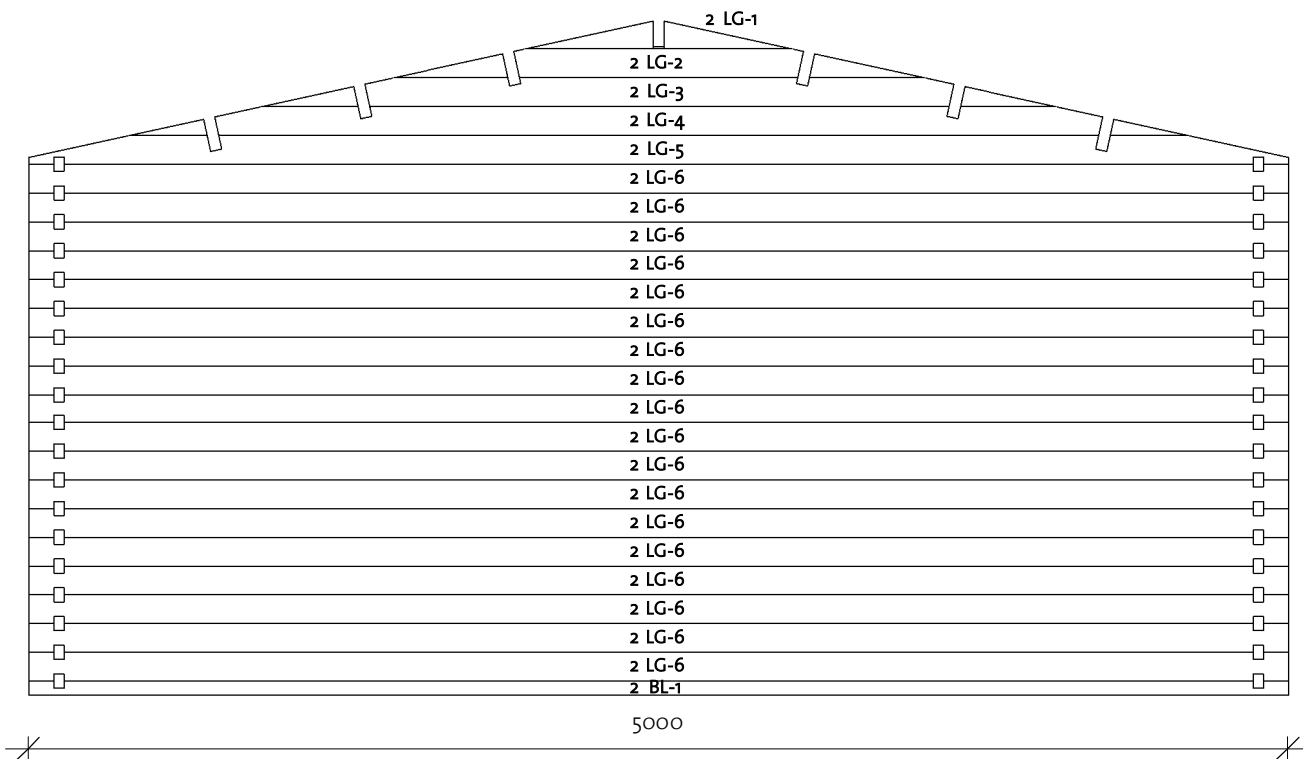

Log Profile Wall 2	
Profile	Profile

40x57	
40x114	

Brunswick EZ 40 (480x480)

Wall A

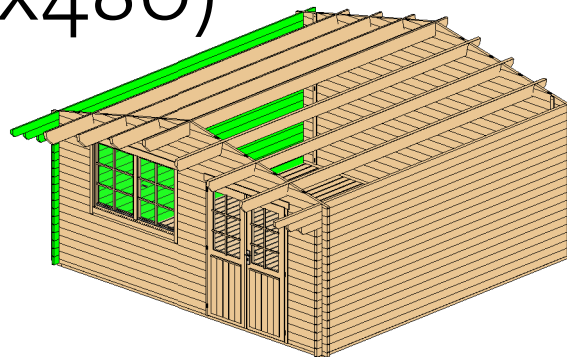

Wall A			
Mark	Profile	Count	Cut Length

ALG-1	40x114	16	5000
ALG-2	40x114	1	5300
ALG-3	40x114	1	5550
ATL-1	40x114	1	5900

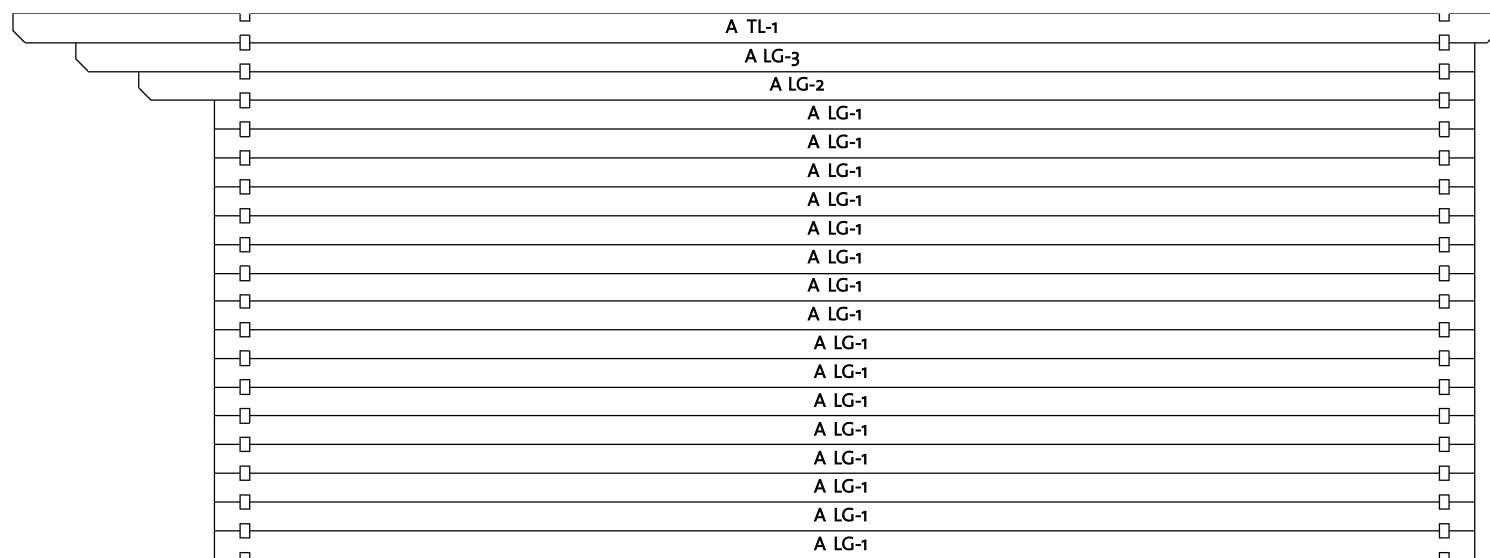

Log Profile Wall A	
Profile	Profile

40X114	
40X114	

Brunswick EZ 40 (480x480)

Wall B

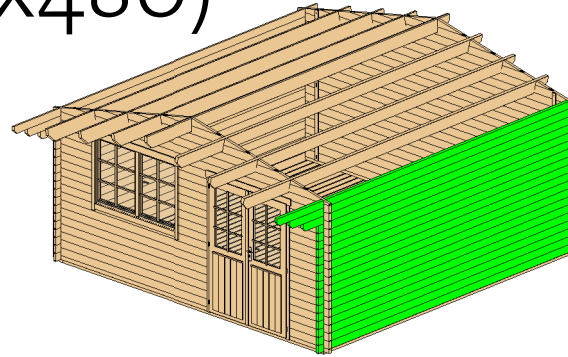

Wall B			
Mark	Profile	Count	Cut Length

BLG-1	40x114	16	5000
BLG-2	40x114	1	5300
BLG-3	40x114	1	5550
BTL-1	40x114	1	5900

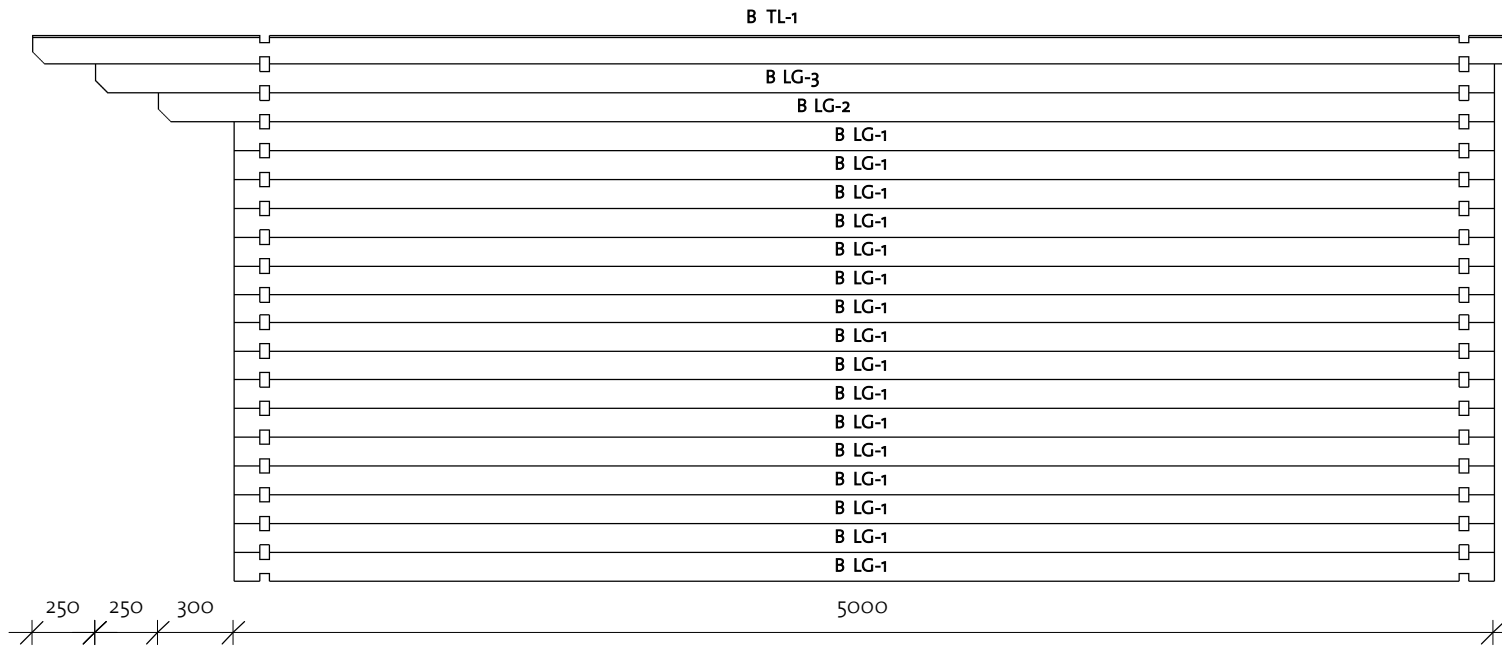





Log Profile Wall B	
Profile	Profile

40X114	
40X114	

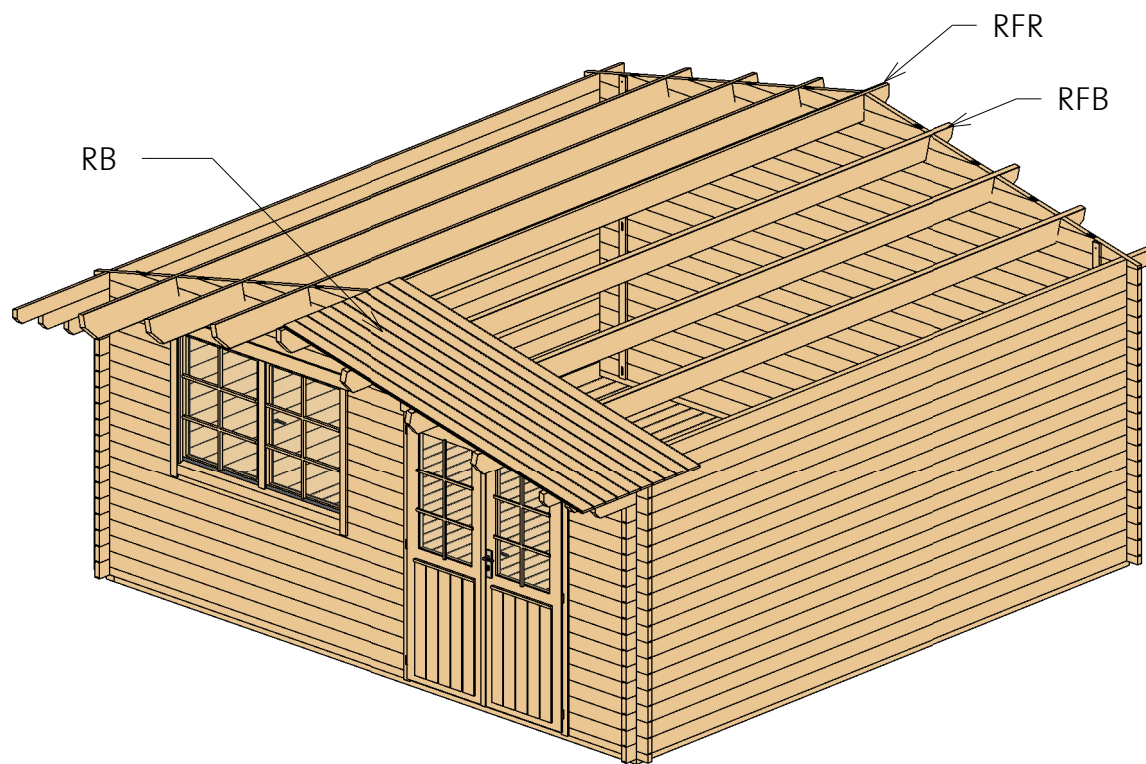
Brunswick EZ 40 (480x480)

Roof 1



Roof				
Mark	Type	Profile	Count	Length
RFR	Ridge 45x195		1	5900
RFB	Beam 45x195		6	5900
RB	17x114		104	2770

Brunswick EZ 40 (480x480)

Roof 2

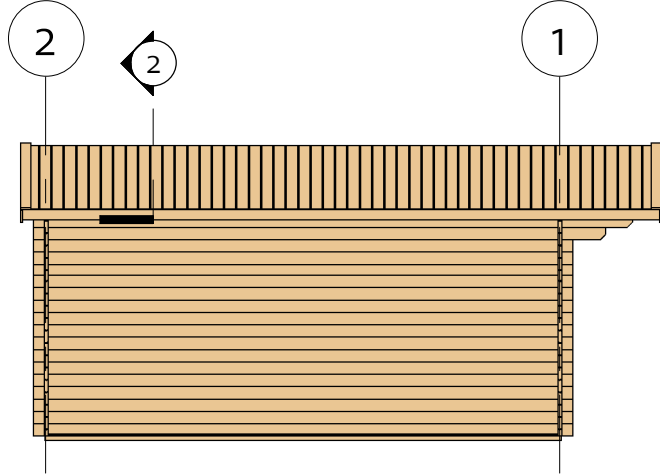

2) Facia

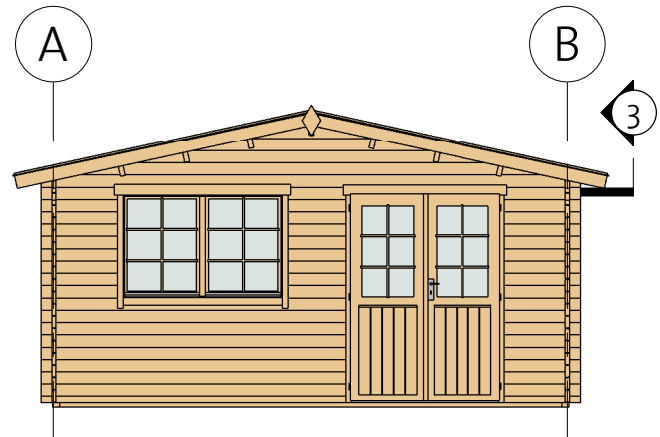
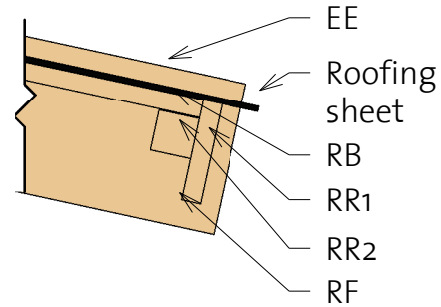

3) Roof Reinforcement

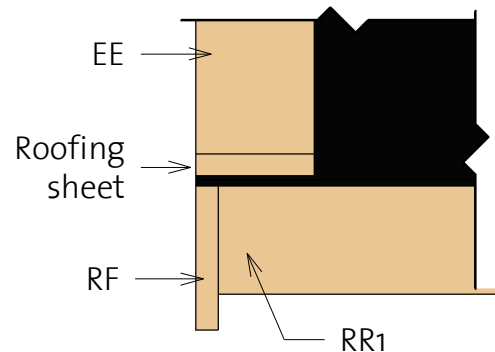

Fascia Schedule

Mark	Type	Profile	Count	Length
EE	Eave Edging 18x95		4	2809
RF	Roof Fascia 18x120		4	2809
RR1	Roof reinforcement 18x95		2	5900
RR2	Roof reinforcement 38x38		2	5900

Brunswick EZ 40 (480x480)

Extras

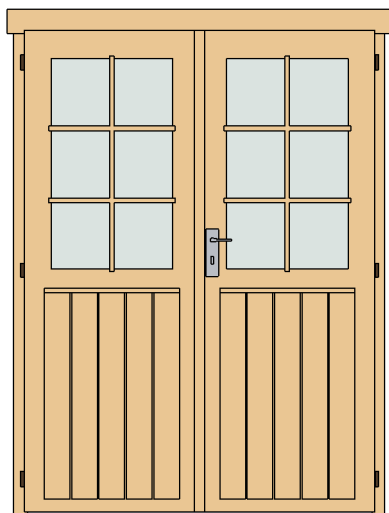

Door Schedule				
Mark	Type	Width	Height	Count
CDD1R	Classic double door 1 right	1425	1955	1
DCB6	Door Crossbar 6	--	--	2

Window Schedule				
Mark	Type	Width	Height	Count
CDW1	Classic double window 1	1530	990	1
WCB6	Windows Crossbar 6	--	--	2

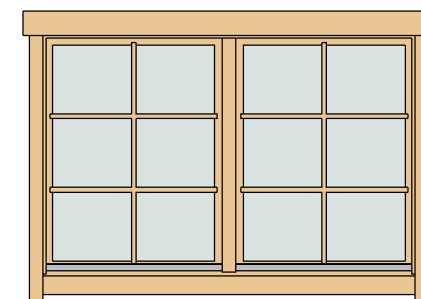

Fasteners & Extras		
Name	Type	Count

Hitblock	300-400 mm	
Bolts	M8 x 70	12
Screws	5,0 x 70	15
Nails	1,4 x 40	50
Screws	6,0 x 140	70
Screws	4,0 x 40	1130



Type	Count	Length
Windboard 18x40	4	2200



Family	Count
Romb	2





Brunswick EZ 40 (480x480)

List of all items 1





Impregnated foundation beams

Mark	Type	Profile	Count	Length
IFB1	IFB 70x40		9	4650
IFB2	IFB 70x40		2	4790



Floor Schedule

Mark	Type	Profile	Count	Length
FB	FB 17x114		43	4714
BB	BB 20x40		4	4800

Fascia Schedule

Mark	Type	Profile	Count	Length
EE	Eave Edging 18x95		4	2809
RF	Roof Fascia 18x120		4	2809
RR1	Roof reinforcement 18x95		2	5900
RR2	Roof reinforcement 38x38		2	5900

Roof

Mark	Type	Profile	Count	Length
RFR	Ridge 45x195		1	5900
RFB	Beam 45x195		6	5900
RB	17x114		104	2770

Brunswick EZ 40 (480x480)

List of all items 2

Wall 1			
Mark	Profile	Count	Cut Length

1BL-1	40x57	1	725
1BL-2	40x57	1	2835
1LG-1	40x114	9	570
1LG-2	40x114	26	725
1LG-3*	40x114	1	1050
1LG-4*	40x114	1	2099
1LG-5*	40x114	1	3147
1LG-6*	40x114	1	4196
1LG-7	40x114	8	2835
1LG-8*	40x114	1	5000
1LG-9	40x114	1	5000

Wall 2			
Mark	Profile	Count	Cut Length

2BL-1	40x57	1	5000
2LG-1*	40x114	1	1050
2LG-2*	40x114	1	2099
2LG-3*	40x114	1	3147
2LG-4*	40x114	1	4196
2LG-5*	40x114	1	5000
2LG-6	40x114	18	5000

* Gable - delivered premounted



Wall A			
Mark	Profile	Count	Cut Length

ALG-1	40x114	16	5000
ALG-2	40x114	1	5300
ALG-3	40x114	1	5550
ATL-1	40x114	1	5900

Wall B			
Mark	Profile	Count	Cut Length

BLG-1	40x114	16	5000
BLG-2	40x114	1	5300
BLG-3	40x114	1	5550
BTL-1	40x114	1	5900

Log Profiles	
Profile	Profile

40x57	
40x114	

Log Profiles	
Profile	Profile

40x114	
--------	---

Windboard

① Windboard Assembly 1



② Windboard Assembly 2

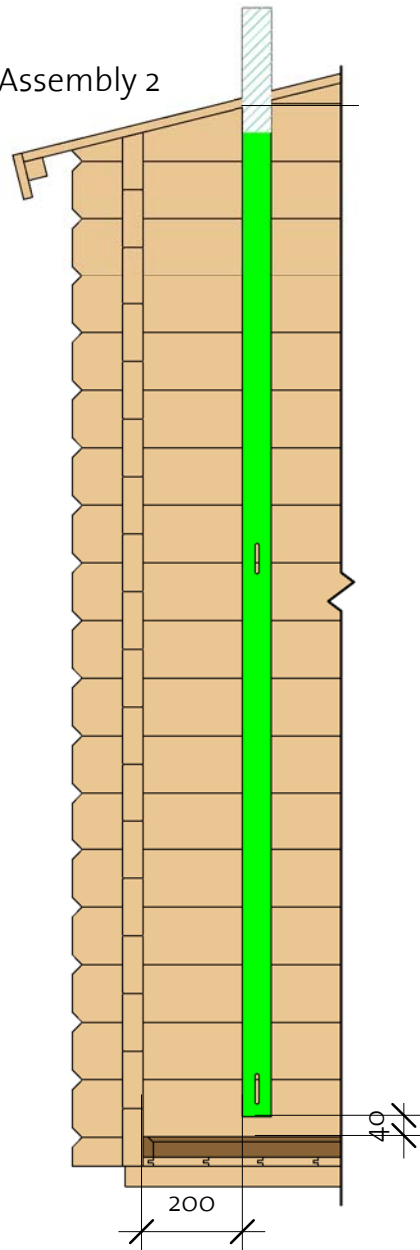

③ Windboard Assembly 3

