

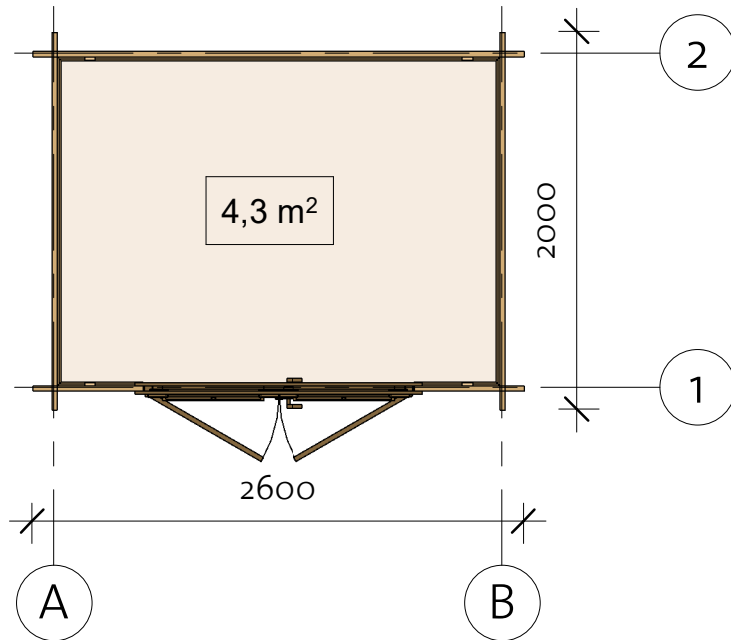

Carol 28 (240x180)

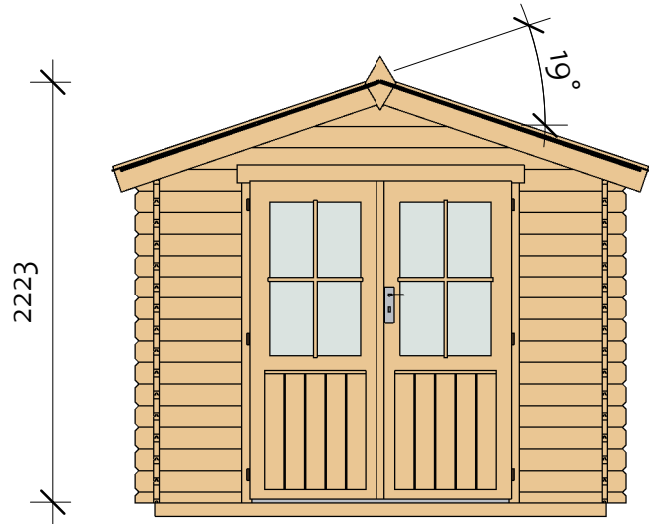
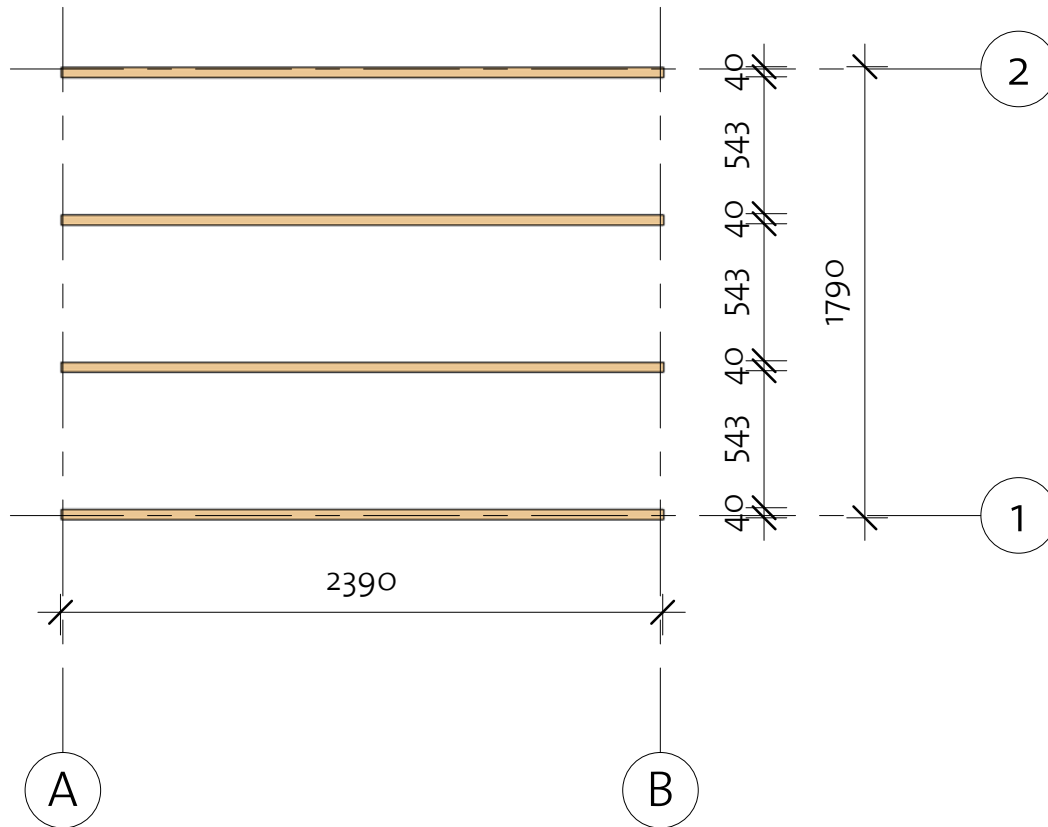

Carol 28 (240x180)

Foundation





Impregnated foundation beams				
Mark	Type	Profile	Count	Length
IFB	IFB 40x70		4	2390

Carol 28 (240x180)

Floor Plan

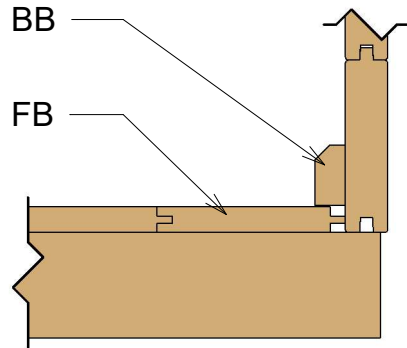
① Baseboard



Floor Schedule				
Mark	Type	Profile	Count	Length
FB	FB 17x114		22	1741
BB1	BB 20x40		2	1800
BB2	BB 20x40		2	2400

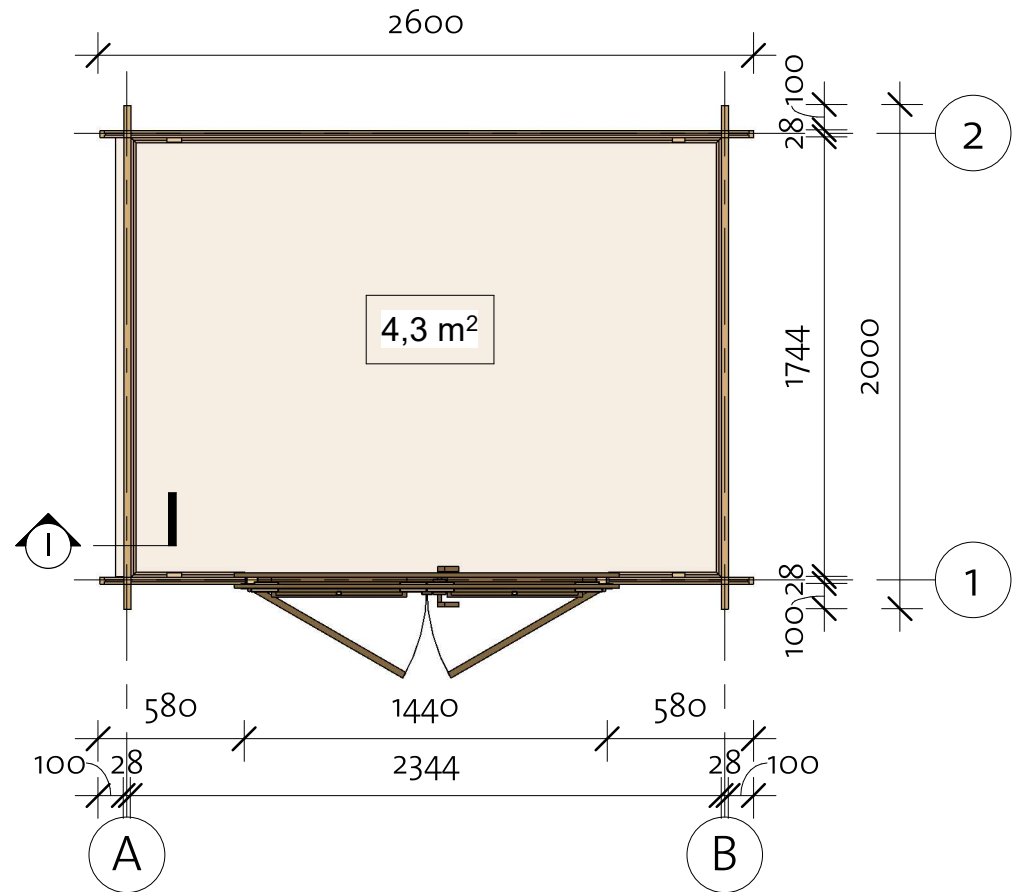

Carol 28 (240x180)

Wall 1

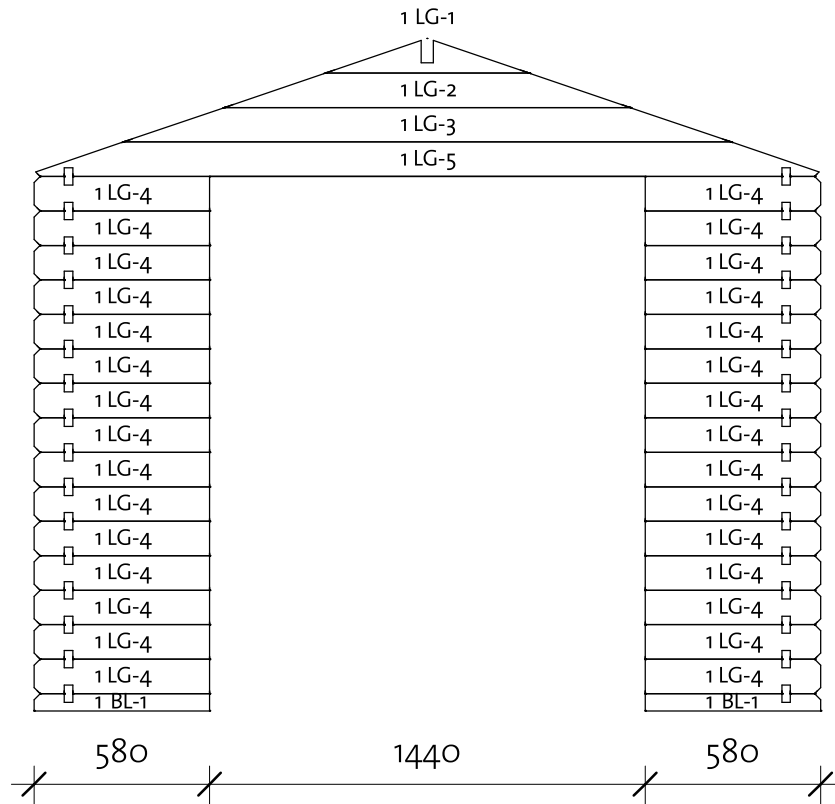
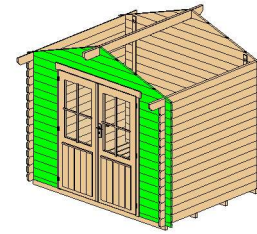

Wall 1			
Mark	Profile	Count	Cut Length

1BL-1	28x57	2	580
1LG-1*	28x114	1	672
1LG-2*	28x114	1	1341
1LG-3*	28x114	1	2010
1LG-4	28x114	30	580
1LG-5*	28x114	1	2590

* Gable - delivered premounted

Log Profile Wall 1	
Profile	Profile

28x57	
28x114	

Carol 28 (240x180)

Wall A

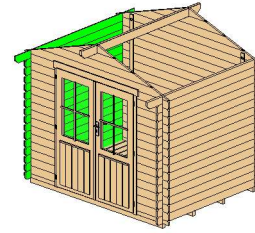

Wall A			
Mark	Profile	Count	Cut Length
ALG-1	28x114	15	2000
ATL-1	28x114	1	2300

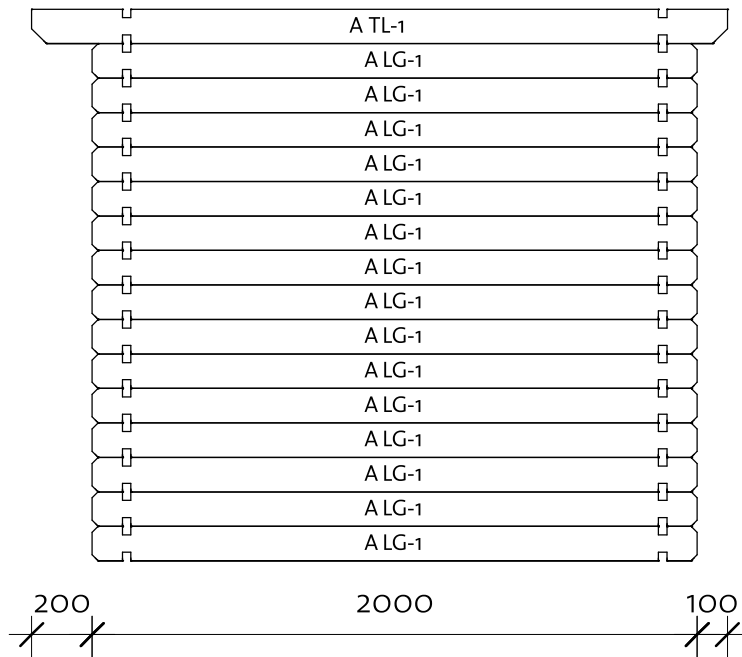

Log Profile Wall A	
Profile	Profile
28x114	
28x114	

Carol 28 (240x180)

Wall B

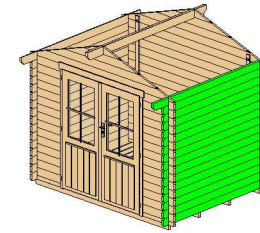

Wall B			
Mark	Profile	Count	Cut Length
BLG-1	28x114	15	2000
BTL-1	28x114	1	2300

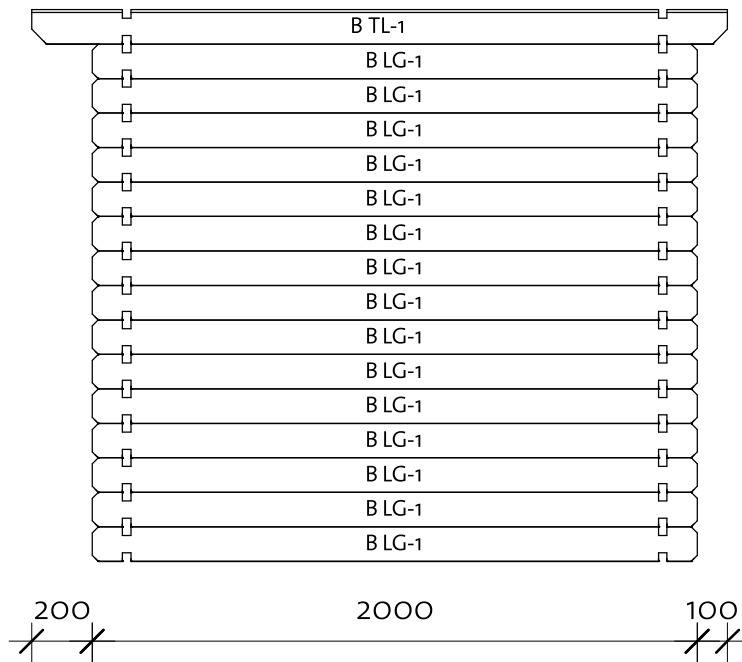



Log Profile Wall B	
Profile	Profile
28x114	
28x114	

Carol 28 (240x180)

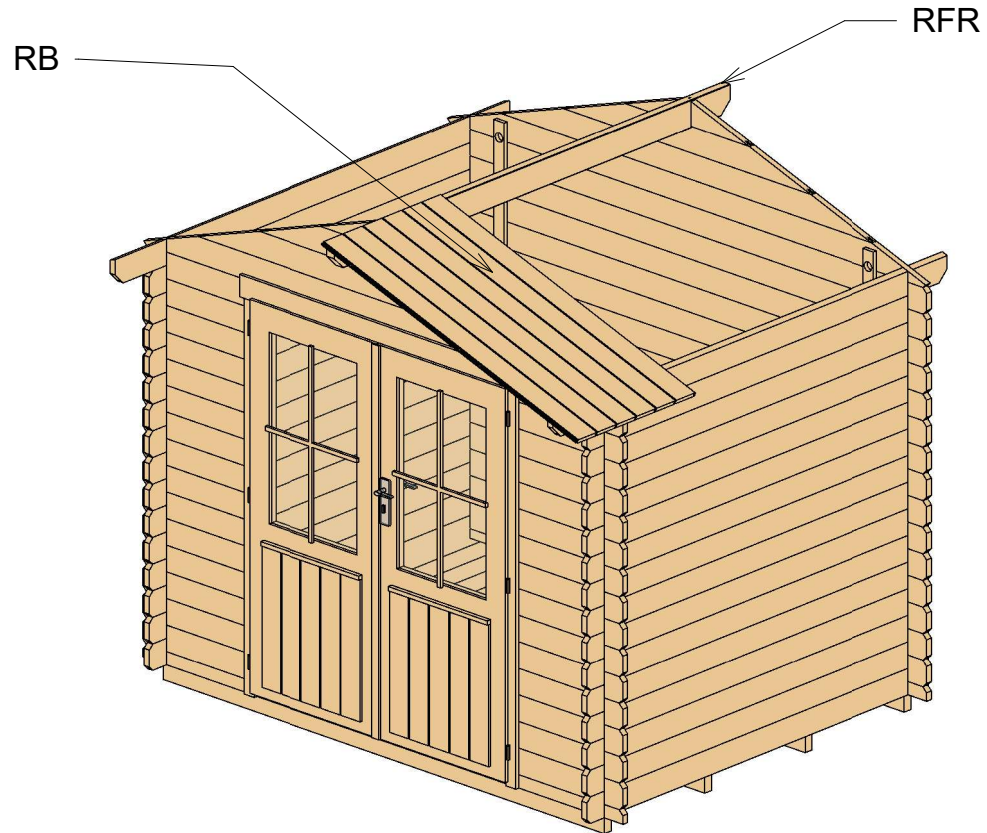
Roof 1



Roof				
Mark	Type	Profile	Count	Length
RFR	Ridge 40x120		1	2300
RB	17x114		42	1452

Carol 28 (240x180)

Roof 2

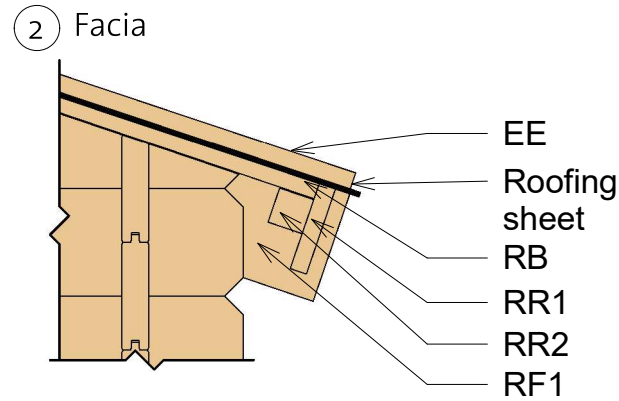
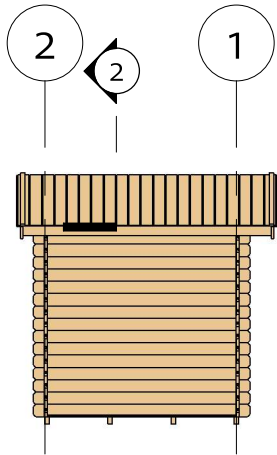

3 Roof Reinforcement

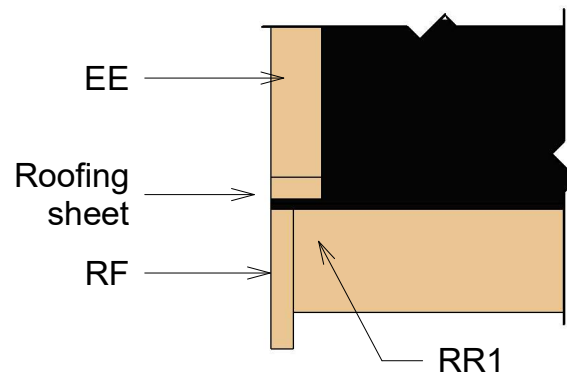
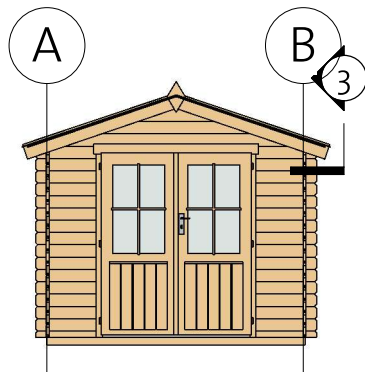

Fascia Schedule				
Mark	Type	Profile	Count	Length
EE	Eave Edging 18x40		4	1490
RF	Roof Fascia 18x120		4	1492
RR1	Roof reinforcement 18x95		2	2300
RR2	Roof reinforcement 38x38		2	2300

Carol 28 (240x180)

Extras

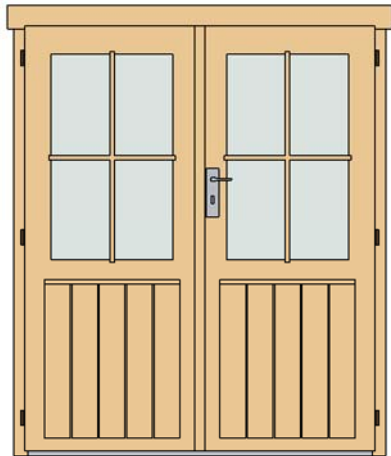

Door Schedule				
Mark	Type	Width	Height	Count
BDD7R	Basic double door 7 right	1425	1730	1
DCB4	Door Crossbar 4	--	--	2

Fasteners & Extras		
Name	Type	Count

Hitblock	300-400 mm	
Screws	5,0 x 70	10
Bolt	M8 x 60	12
Screws	6,0 x 140	25
Nails	1,4 x 40	30
Screws	4,0 x 40	60
Screws	4,0 x 50	200

Family	Count
--------	-------

Romb	2
------	---



Type	Count	Length
------	-------	--------

Windboard 18x40	4	2200
-----------------	---	------



190826



Carol 28 (240x180)

List of all items 1



Impregnated foundation beams

Mark	Type	Profile	Count	Length
IFB	IFB 40x70		4	2390





Floor Schedule

Mark	Type	Profile	Count	Length
FB	FB 17x114		22	1741
BB1	BB 20x40		2	1800
BB2	BB 20x40		2	2400

Roof

Mark	Type	Profile	Count	Length
RFR	Ridge 40x120		1	2300
RB	17x114		42	1452

Fascia Schedule

Mark	Type	Profile	Count	Length
EE	Eave Edging 18x40		4	1490
RF	Roof Fascia 18x120		4	1492
RR1	Roof reinforcement 18x95		2	2300
RR2	Roof reinforcement 38x38		2	2300

Carol 28 (240x180)

List of all items 2

Wall 1			
Mark	Profile	Count	Cut Length

1BL-1	28x57	2	580
1LG-1*	28x114	1	672
1LG-2*	28x114	1	1341
1LG-3*	28x114	1	2010
1LG-4	28x114	30	580
1LG-5*	28x114	1	2590

* Gable - delivered premounted

Wall 2			
Mark	Profile	Count	Cut Length

2BL-1	28x57	1	2600
2LG-1*	28x114	1	672
2LG-2*	28x114	1	1341
2LG-3*	28x114	1	2010
2LG-4*	28x114	1	2590
2LG-5	28x114	15	2600



Wall A			
Mark	Profile	Count	Cut Length

ALG-1	28x114	15	2000
ATL-1	28x114	1	2300

Wall B			
Mark	Profile	Count	Cut Length

BLG-1	28x114	15	2000
BTL-1	28x114	1	2300

Log Profiles	
Profile	Profile

28x57	
28x114	

Log Profiles	
Profile	Profile

28x114	
--------	---