

Cassidy Bunkie 40 (549x549)

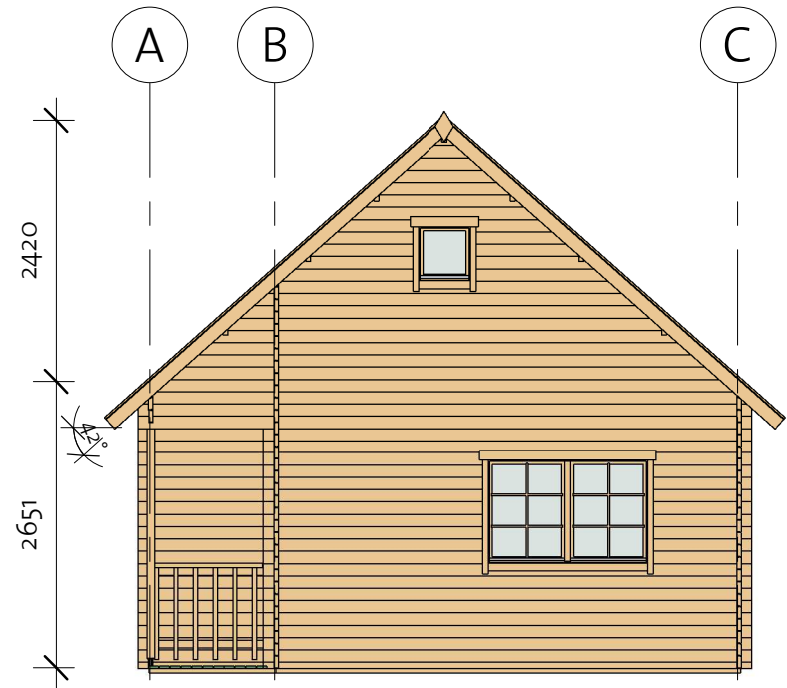

Cassidy Bunkie 40 (549x549)

Foundation

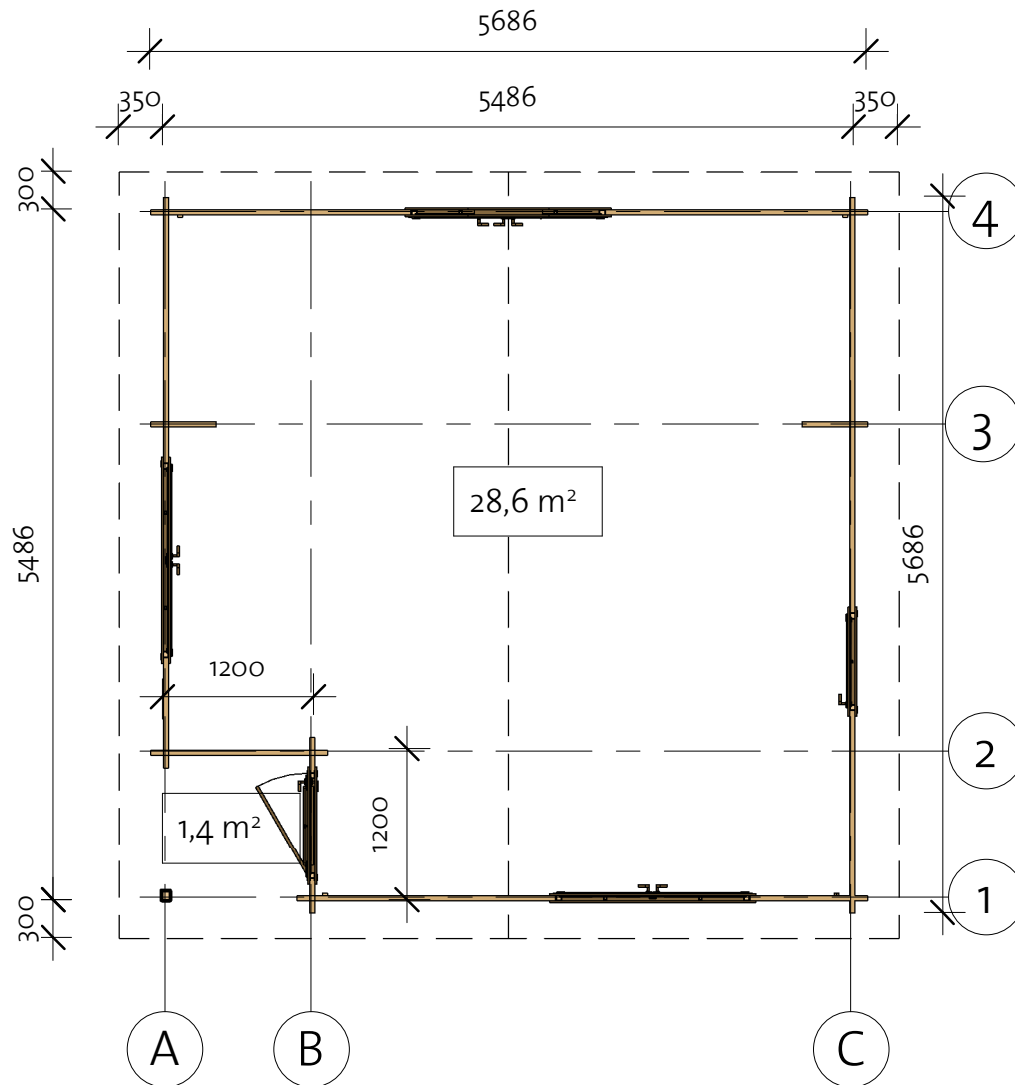
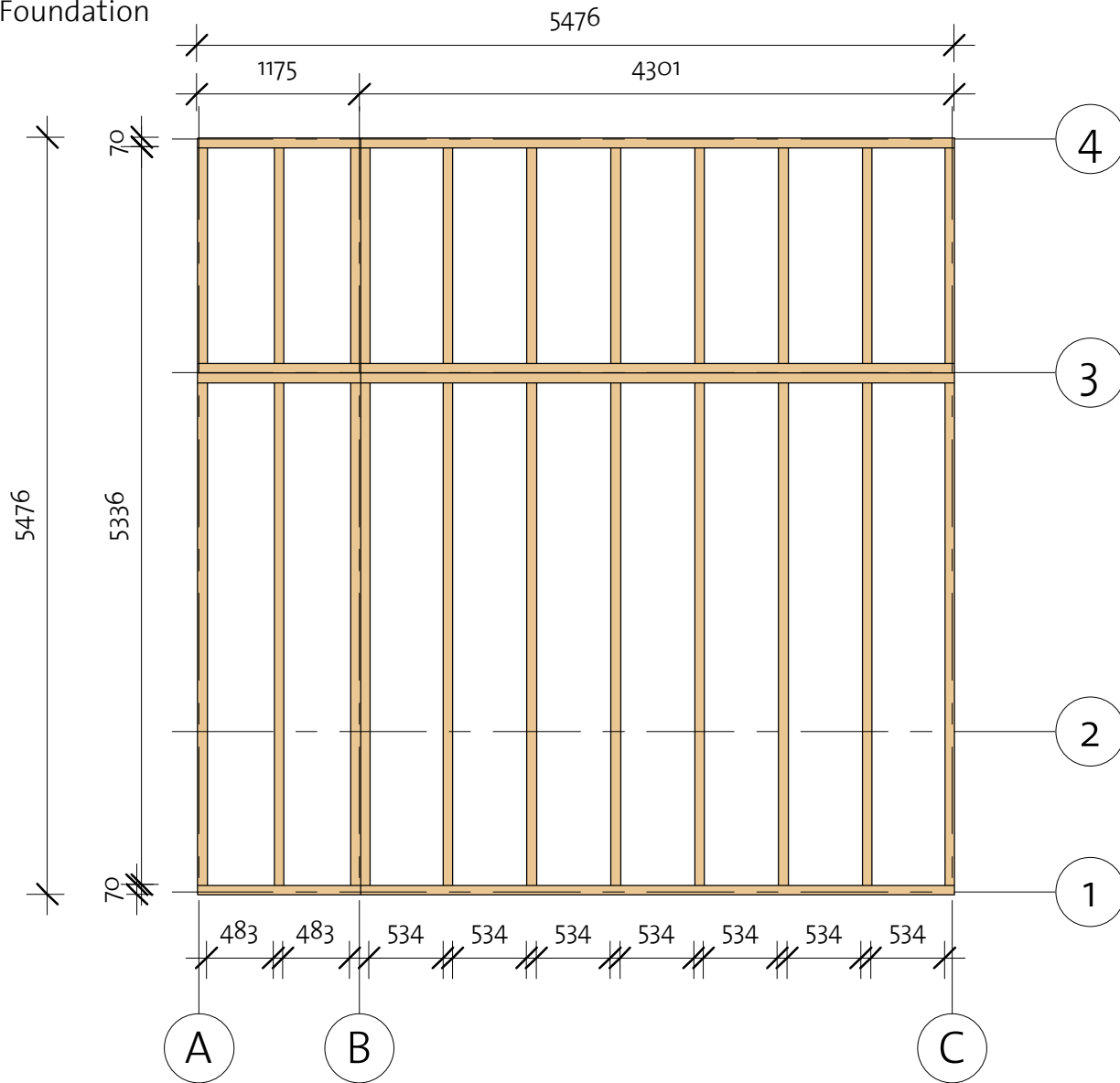

Impregnated foundation beams				
Mark	Type	Profile	Count	Length

IFB1	IFB 70x40		11	1564
IFB2	IFB 70x40		11	3632
IFB3	IFB 70x40		4	4301
IFB4	IFB 70x40		4	1175

Cassidy Bunkie 40 (549x549)

Floor Plan

① Baseboard

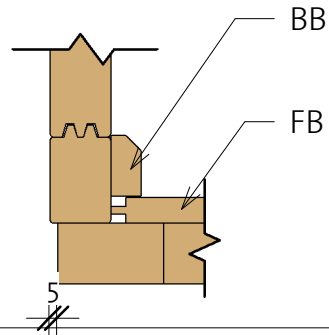

Floor Schedule

Mark	Type	Profile	Count	Length
------	------	---------	-------	--------

FB1	FB 17x114		53	5395
FB2	FB 17x114		11	4240

BB 1	BB 18x40		5	5600
------	----------	---	---	------

Terrace Schedule

TB	TB 21x95		11	1160
----	----------	---	----	------

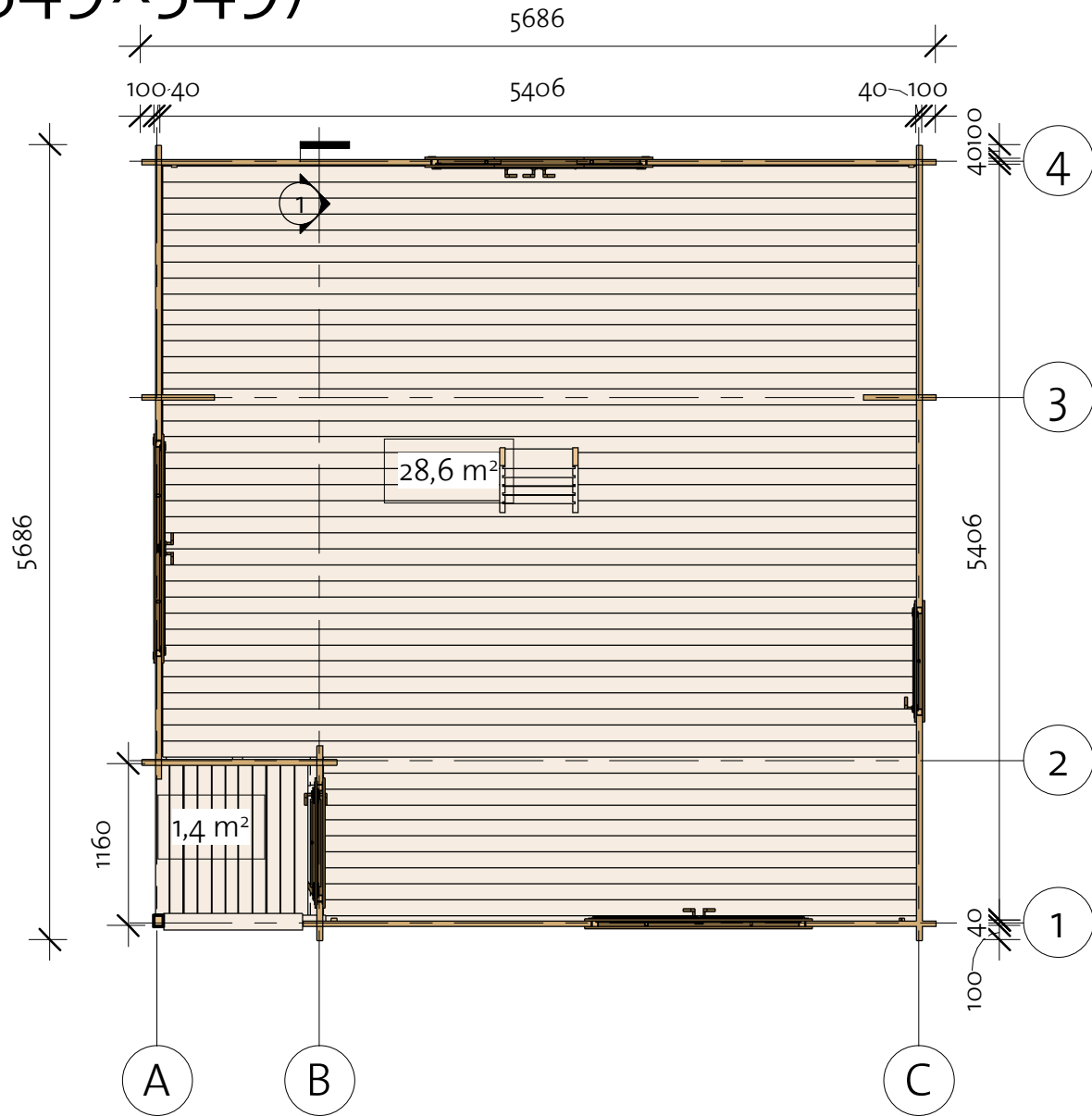

Cassidy Bunkie 40 (549x549)

Wall 1

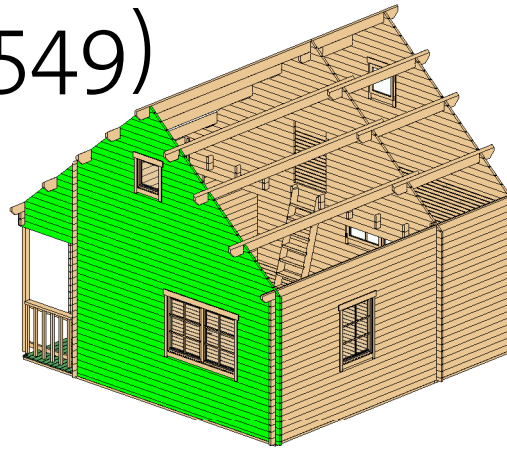

Log Profile Wall 1	
Profile	Profile

Log Profile Wall 1	
Profile	Profile

40x57	
-------	---

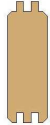
40x114	
--------	---

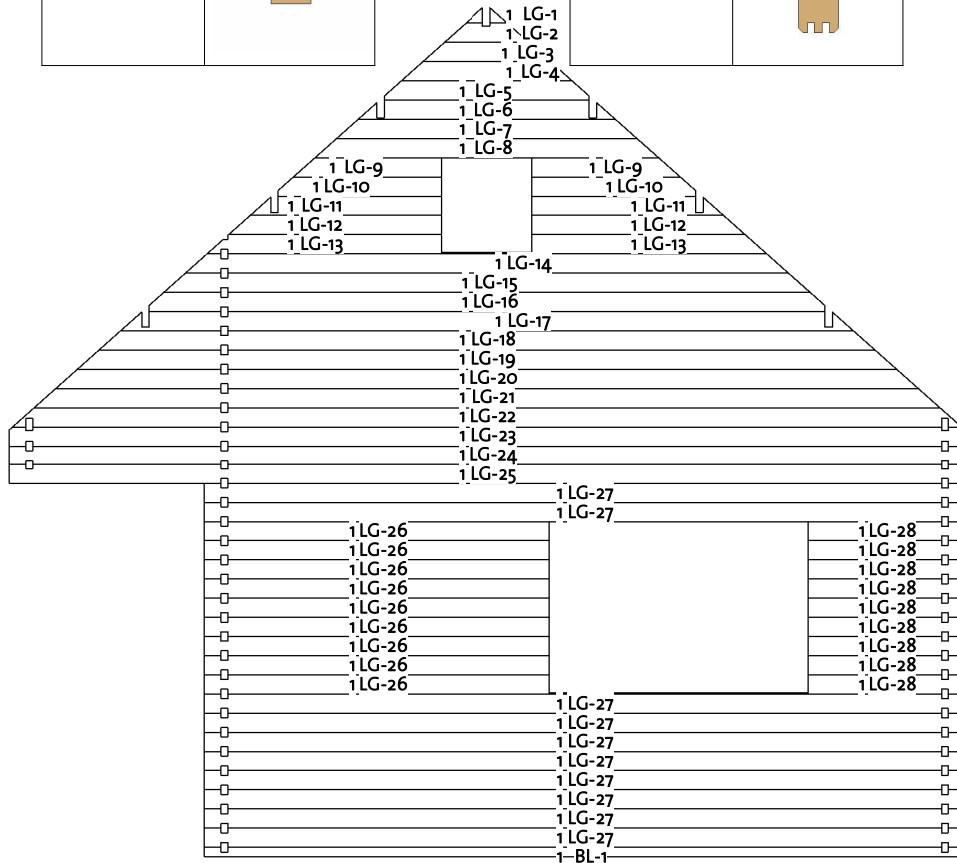

Wall 1			
Mark	Profile	Count	Cut Length

1BL-1	40x57	1	4526
1LG-1 *	40x114	1	251
1LG-2 *	40x114	1	508
1LG-3 *	40x114	1	765
1LG-4 *	40x114	1	1022
1LG-5 *	40x114	1	1225
1LG-6 *	40x114	1	1535
1LG-7 *	40x114	1	1792
1LG-8 *	40x114	1	2049
1LG-9 *	40x114	2	880
1LG-10 *	40x114	2	971
1LG-11 *	40x114	2	1137
1LG-12 *	40x114	2	1266
1LG-13 *	40x114	2	1394
1LG-14 *	40x114	1	3590

Wall 1			
Mark	Profile	Count	Cut Length

1LG-15 *	40x114	1	3847
1LG-16 *	40x114	1	4020
1LG-17 *	40x114	1	4361
1LG-18 *	40x114	1	4617
1LG-19 *	40x114	1	4874
1LG-20 *	40x114	1	5131
1LG-21 *	40x114	1	5388
1LG-22 *	40x114	1	5645
1LG-23 *	40x114	1	5686
1LG-24	40x114	1	5686
1LG-25	40x114	1	5686
1LG-26	40x114	9	2056
1LG-27	40x114	10	4526
1LG-28	40x114	9	930

* Gable - delivered premounted

*

Cassidy Bunkie 40 (549x549)

Wall 2

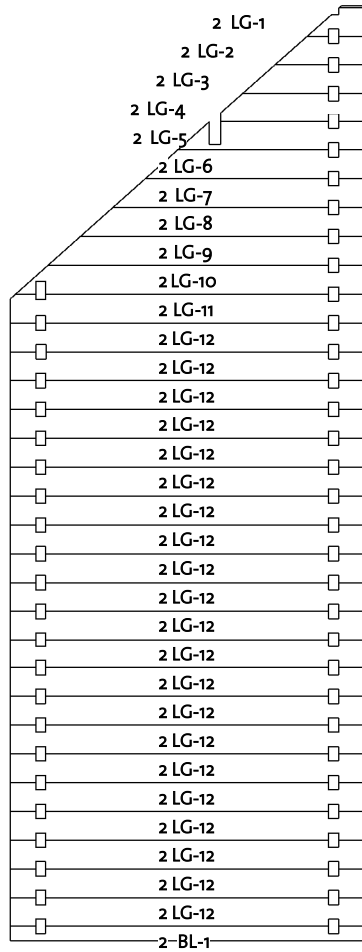
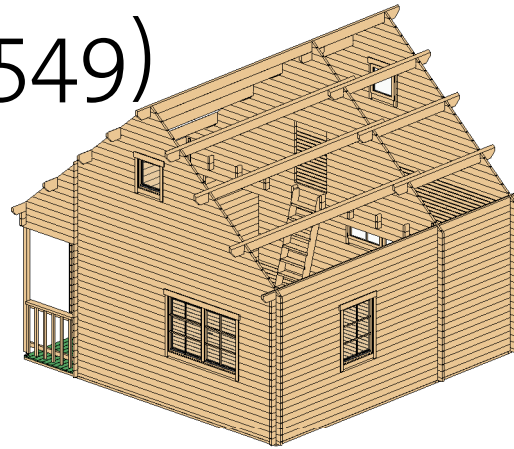

Wall 2			
Mark	Profile	Count	Cut Length

2BL-1	40X57	1	1400
2LG-1 *	40X114	1	224
2LG-2 *	40X114	1	352
2LG-3 *	40X114	1	480
2LG-4 *	40X114	1	567
2LG-5 *	40X114	1	737
2LG-6 *	40X114	1	866
2LG-7 *	40X114	1	994
2LG-8 *	40X114	1	1123
2LG-9 *	40X114	1	1251
2LG-10*	40X114	1	1379
2LG-11 *	40X114	1	1400
2LG-12	40X114	21	1400

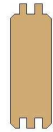

Log Profile Wall 2	
Profile	Profile

40X57	
40X114	

Cassidy Bunkie 40 (549x549)

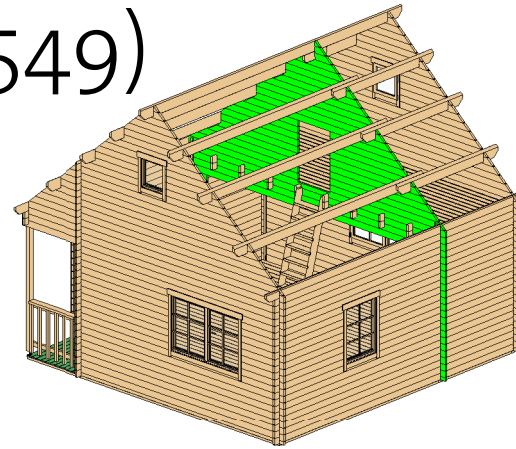
Wall 3



Log Profile Wall 3	
Profile	Profile
40x57	
40x114	

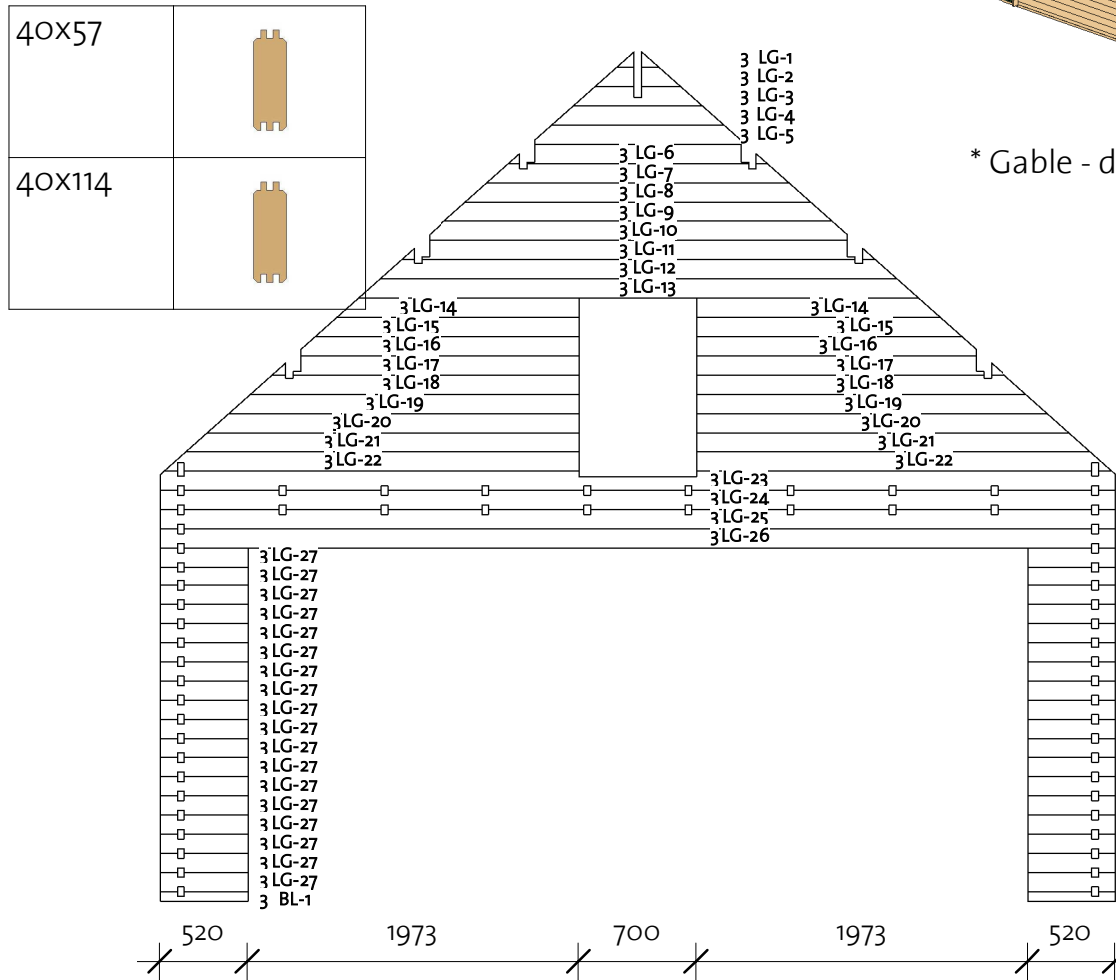

* Gable - delivered premounted

Wall 3			
Mark	Profile	Count	Cut Length

3BL-1	40x57	2	520
3LG-1 *	40x114	1	251
3LG-2 *	40x114	1	508
3LG-3 *	40x114	1	765
3LG-4 *	40x114	1	1022
3LG-5 *	40x114	1	1225
3LG-6 *	40x114	1	1535
3LG-7 *	40x114	1	1792
3LG-8 *	40x114	1	2049
3LG-9 *	40x114	1	2306
3LG-10 *	40x114	1	2487
3LG-11 *	40x114	1	2820
3LG-12 *	40x114	1	3076
3LG-13 *	40x114	1	3333
3LG-14 *	40x114	2	1445
3LG-15 *	40x114	2	1573
3LG-16 *	40x114	2	1660
3LG-17 *	40x114	2	1830
3LG-18 *	40x114	2	1959
3LG-19 *	40x114	2	2087
3LG-20 *	40x114	2	2216
3LG-21 *	40x114	2	2344
3LG-22 *	40x114	2	2472
3LG-23 *	40x114	1	5686
3LG-24	40x114	1	5686
3LG-25	40x114	1	5686
3LG-26	40x114	1	5686
3LG-27	40x114	36	520

Cassidy Bunkie 40 (549x549)

Wall 4

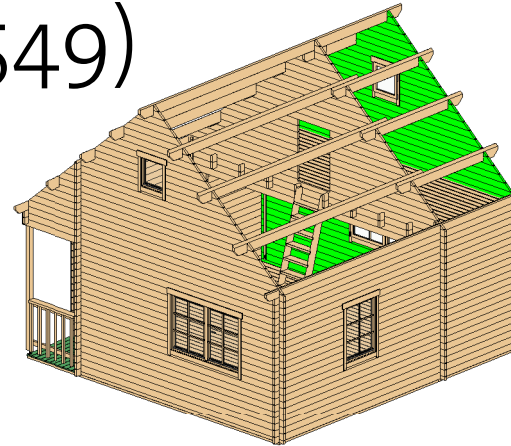

Log Profile Wall 4	
Profile	Profile

40X57	
40X114	

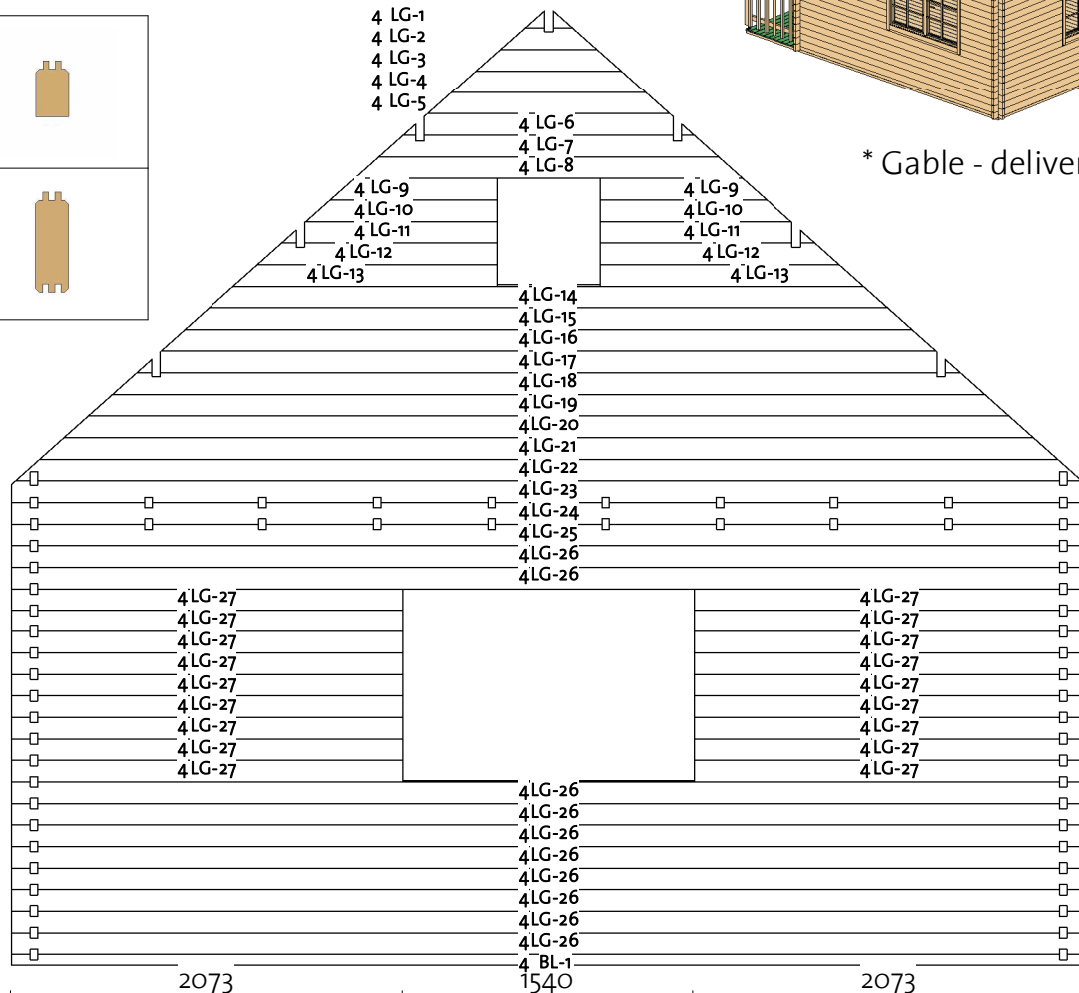

* Gable - delivered premounted

Wall 4			
Mark	Profile	Count	Cut Length
4BL-1	40X57	1	5686
4LG-1 *	40X114	1	251
4LG-2 *	40X114	1	508
4LG-3 *	40X114	1	765
4LG-4 *	40X114	1	1022
4LG-5 *	40X114	1	1279
4LG-6 *	40X114	1	1535
4LG-7 *	40X114	1	1792
4LG-8 *	40X114	1	2049
4LG-9 *	40X114	2	880
4LG-10 *	40X114	2	1009
4LG-11 *	40X114	2	1137
4LG-12 *	40X114	2	1266
4LG-13 *	40X114	2	1394
4LG-14 *	40X114	1	3590
4LG-15 *	40X114	1	3847
4LG-16 *	40X114	1	4104
4LG-17 *	40X114	1	4361
4LG-18 *	40X114	1	4617
4LG-19 *	40X114	1	4874
4LG-20 *	40X114	1	5131
4LG-21 *	40X114	1	5388
4LG-22 *	40X114	1	5645
4LG-23 *	40X114	1	5686
4LG-24	40X114	1	5686
4LG-25	40X114	1	5686
4LG-26	40X114	10	5686
4LG-27	40X114	18	2073

Cassidy Bunkie 40 (549x549)

Wall A

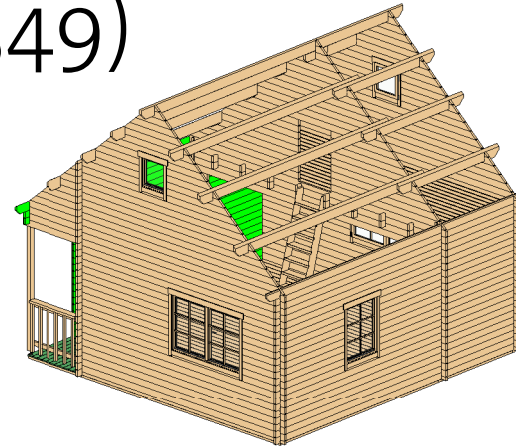

Wall A

Mark	Profile	Count	Cut Length
------	---------	-------	------------

ALG-1	40X114	11	4526
ALG-2	40X114	1	5686
ALG-3	40X114	1	5686
ALG-4	40X114	9	2144
ALG-5	40X114	9	873
ATL-1	40X143	1	2009
ATL-2	40X143	1	4077

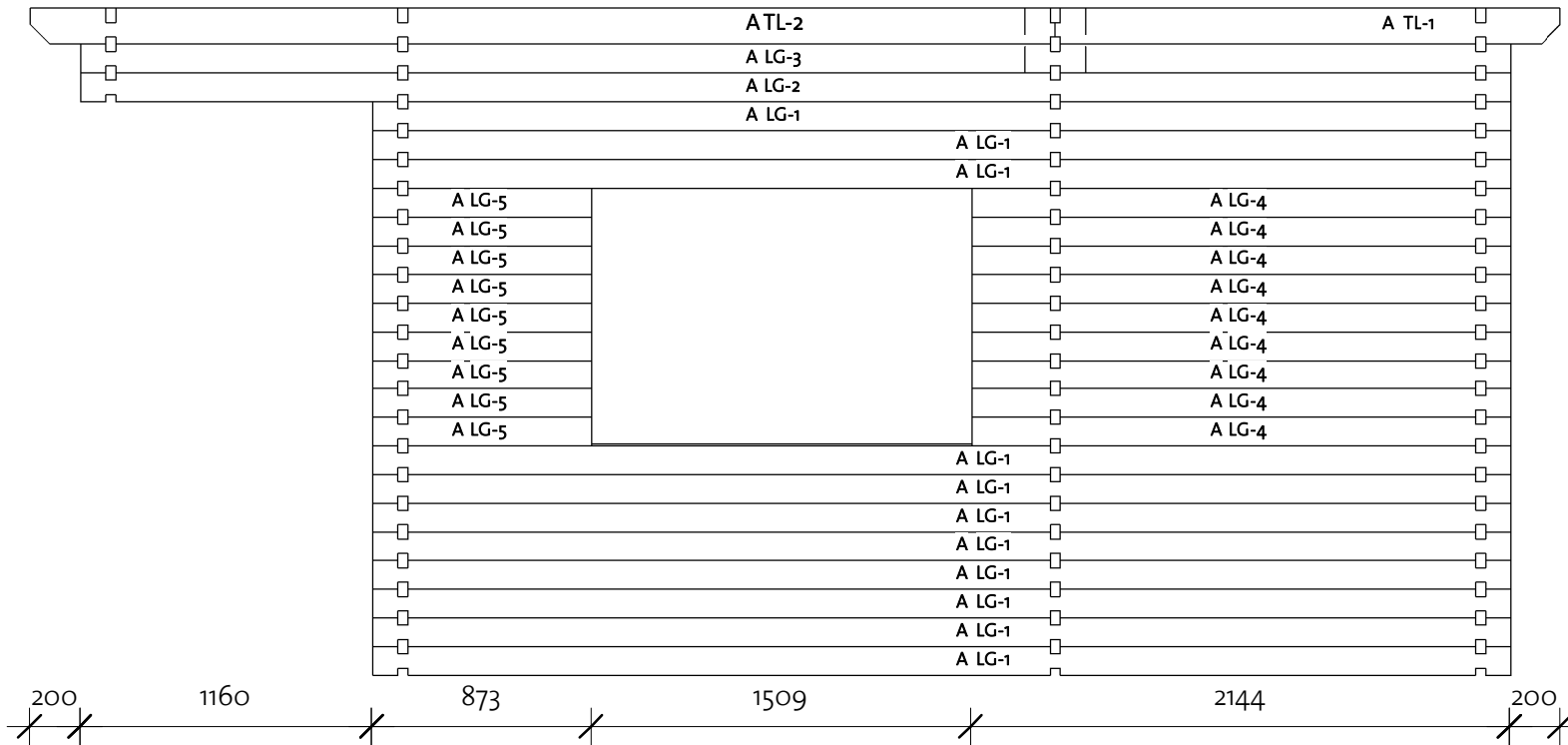

Log Profile Wall A

Profile	Profile
---------	---------

40X114



40X143

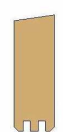

Cassidy Bunkie 40 (549x549)

Wall B

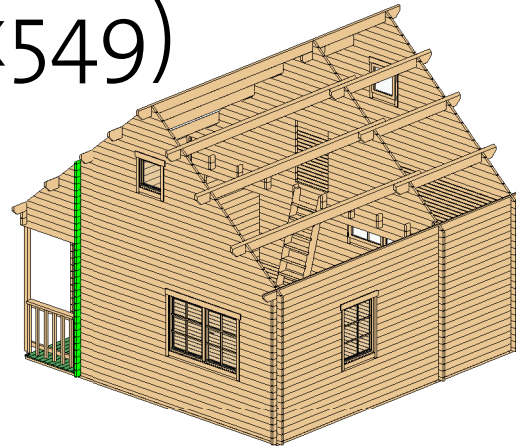

Wall B			
Mark	Profile	Count	Cut Length

BLG-1	40X114	14	1400
BLG-2	40X114	1	1400
BLG-3	40X114	34	275
BTL-1	40X53	1	1400

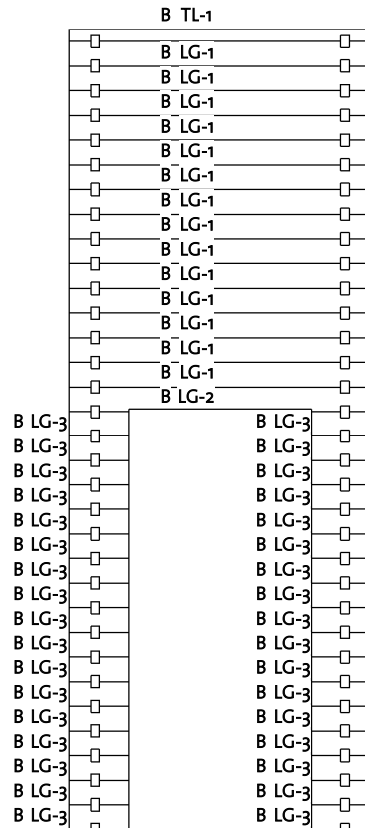

Log Profile Wall B	
Profile	Profile

40X114	
40X53	

Cassidy Bunkie 40 (549x549)

Wall C

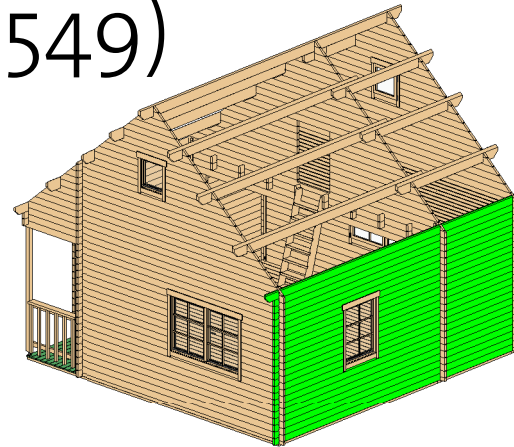

Wall C

Mark	Profile	Count	Cut Length
------	---------	-------	------------

CLG-1	40X114	4	5686
CLG-2	40X114	9	3300
CLG-3	40X114	9	1616
CLG-4	40X114	8	5686
CLG-5	40X114	1	5686
CTL-1	40X143	1	2009
CTL-2	40X143	1	4077

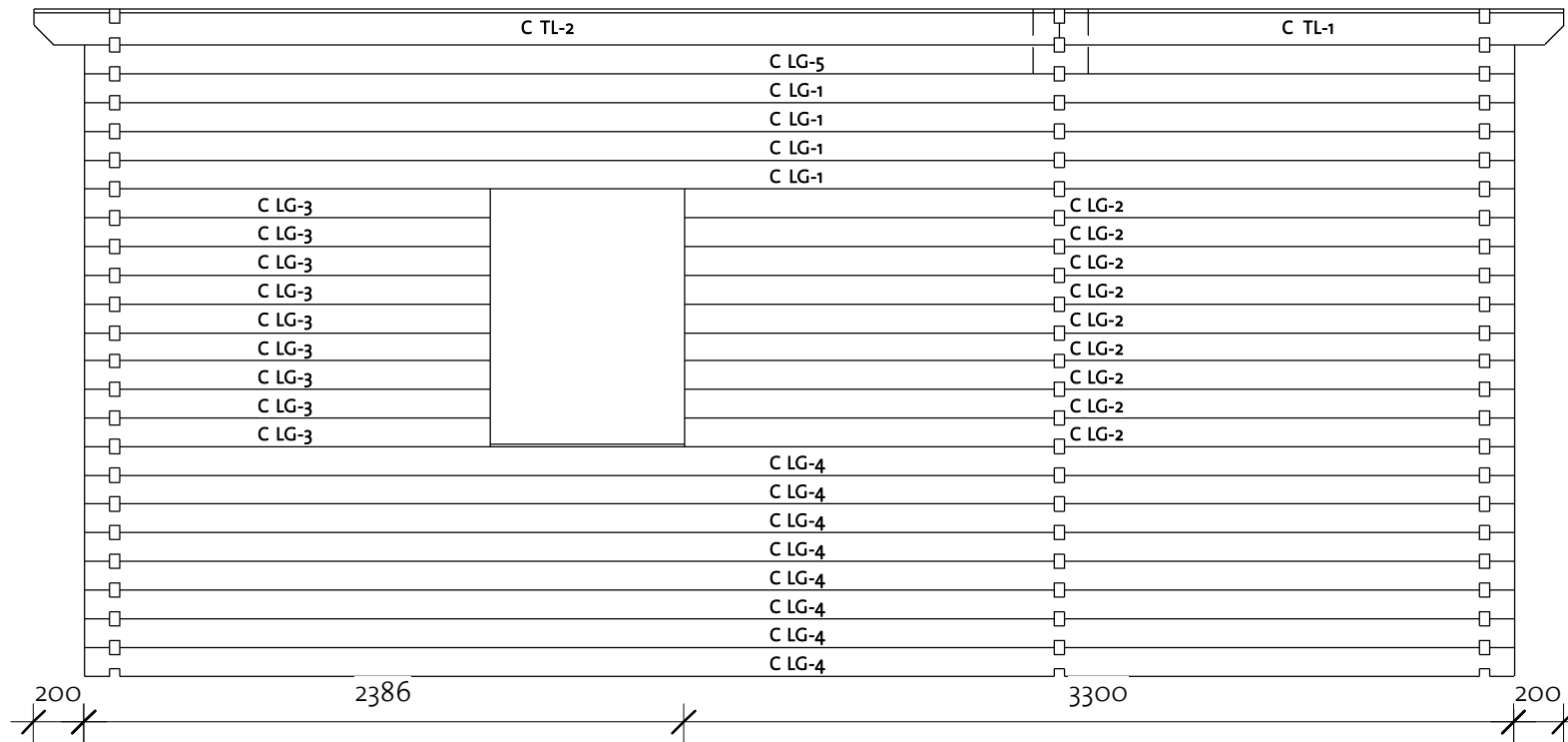

Log Profile Wall C

Profile	Profile
---------	---------

40X114

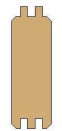

40X143

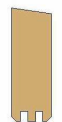

Cassidy Bunkie 40 (549x549)

Roof 1

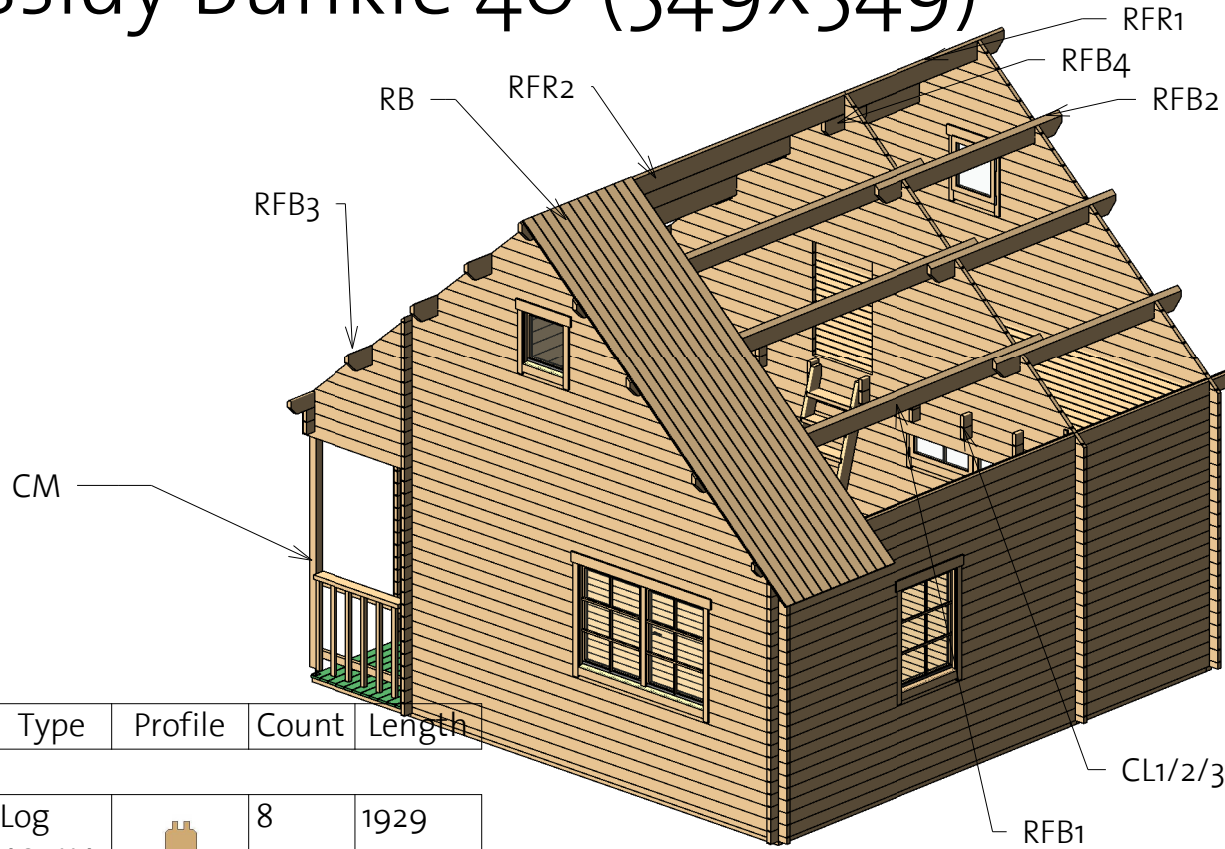

Mark	Type	Profile	Count	Length
------	------	---------	-------	--------

CL1	Log 40x114		8	1929
CL2	Log 40x114		8	1929
CL3	Beam 40x70		2	1648

Columns			
Mark	Profile	Count	Length

CM	Post 80x70	1	2184
----	------------	---	------

Roof				
Mark	Type	Profile	Count	Length

RB	17x114		108	4121
RFB1	Beam 45x195		5	4397
RFB2	Beam 45x195		6	2329
RFB3	Beam 45x195		1	4397
RFB4	Beam 45x143		1	520
RFR1	Ridge 45x195		1	2009
RFR2	Ridge 45x195		1	4077

Cassidy Bunkie 40 (549x549)

Roof 2

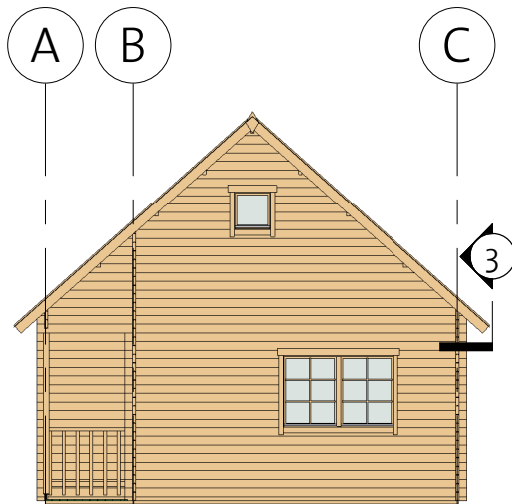
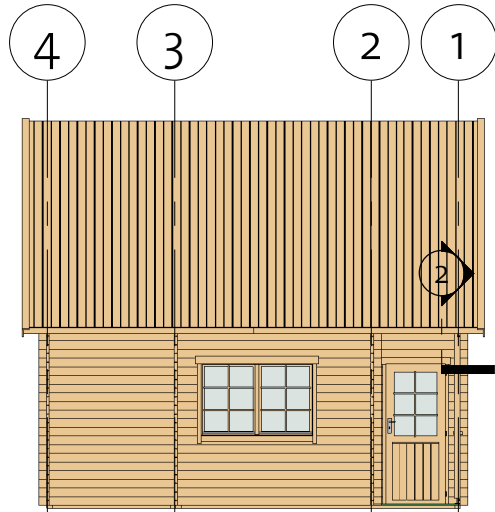

② Facia

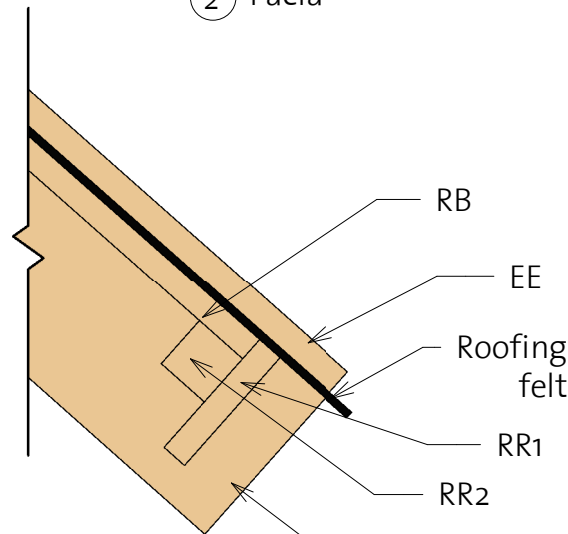

③ Roof Reinforcement

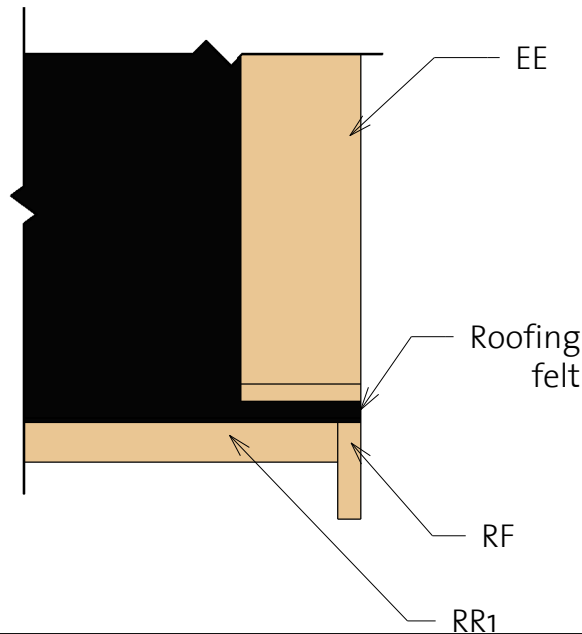

Fascia Schedule

Mark	Type	Profile	Count	Length
EE	Eave Edging 18x95		4	4194
RF	Roof Fascia 18x120		4	4194
RR1	Roof reinforcement 18x95		4	3043
RR2	Roof reinforcement 38x38		4	3043

Cassidy Bunkie 40 (549x549)

Extras



Door Schedule				
Model	Type	Width	Height	Count

CD1R	Classic door 1 right	840	1890	1
------	-------------------------	-----	------	---

DCB6	Door Crossbar 6	--	--	1
------	--------------------	----	----	---

DB	Door beam 850 mm	40	12	1
----	---------------------	----	----	---

Type	Count	Length
------	-------	--------

Windboard 18x40	4	2600
--------------------	---	------

Windboard 18x40 2	2	2300
----------------------	---	------

Type	Count
------	-------



Romb	2
------	---

Fasteners/Extras		
Name	Type	Count

Hitblock	300-400 mm	
Adjustable post foot		1
Dowels	16,0x150	8
Bolts	M8x70	18
Nails	1,4 x 40	65
Screws	5,0 x 70	110
Screws	6,0 x 140	120
Screws	4,0 x 40	1500

Window Schedule				
Mark	Type	Width	Height	Count

CDW1	Classic double window 1	1530	990	3
CW1L	Classic window 1 left	765	990	1
CW12R	Classic window 12, full glass righth	540	540	2

WCB6	Windows Crossbar 6	--	--	7
------	--------------------	----	----	---

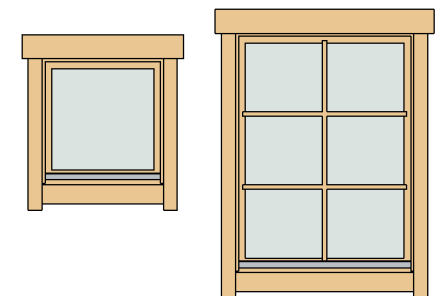
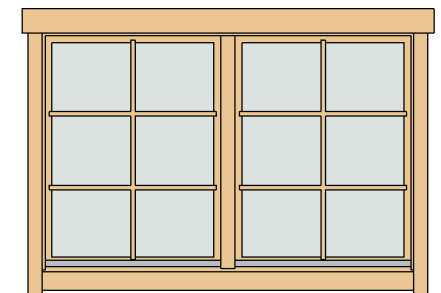





Cassidy Bunkie 40 (549x549)

List of all items 1

Impregnated foundation beams

Mark	Type	Profile	Count	Length
IFB1	IFB 70x40		11	1564
IFB2	IFB 70x40		11	3632
IFB3	IFB 70x40		4	4301
IFB4	IFB 70x40		4	1175

Roof

Mark	Type	Profile	Count	Length
RB	17x114		108	4121
RFB1	Beam 45x195		5	4397
RFB2	Beam 45x195		6	2329
RFB3	Beam 45x195		1	4397
RFB4	Beam 45x143		1	520
RFR1	Ridge 45x195		1	2009
RFR2	Ridge 45x195		1	4077

92403171_240413

Floor Schedule





Mark	Type	Profile	Count	Length
FB1	FB 17x114		53	5395
FB2	FB 17x114		11	4240

BB 1	BB 18x40		5	5600
------	----------	---	---	------

Terrace Schedule

TB	TB 21x95		11	1160
----	----------	---	----	------

Fascia Schedule

Mark	Type	Profile	Count	Length
EE	Eave Edging 18x95		4	4194
RF	Roof Fascia 18x120		4	4194
RR1	Roof reinforce ment 18x95		4	3043
RR2	Roof reinforce ment 38x38		4	3043

Cassidy Bunkie 40 (549x549)

List of all items 2

Wall 1			
Mark	Profile	Count	Cut Length

1BL-1	40X57	1	4526
1LG-1 *	40X114	1	251
1LG-2 *	40X114	1	508
1LG-3 *	40X114	1	765
1LG-4 *	40X114	1	1022
1LG-5 *	40X114	1	1225
1LG-6 *	40X114	1	1535
1LG-7 *	40X114	1	1792
1LG-8 *	40X114	1	2049
1LG-9 *	40X114	2	880
1LG-10 *	40X114	2	971
1LG-11 *	40X114	2	1137
1LG-12 *	40X114	2	1266
1LG-13 *	40X114	2	1394
1LG-14 *	40X114	1	3590
1LG-15 *	40X114	1	3847
1LG-16 *	40X114	1	4020
1LG-17 *	40X114	1	4361
1LG-18 *	40X114	1	4617
1LG-19 *	40X114	1	4874
1LG-20 *	40X114	1	5131
1LG-21 *	40X114	1	5388
1LG-22 *	40X114	1	5645
1LG-23 *	40X114	1	5686
1LG-24	40X114	1	5686
1LG-25	40X114	1	5686
1LG-26	40X114	9	2056
1LG-27	40X114	10	4526
1LG-28	40X114	9	930

Wall 2			
Mark	Profile	Count	Cut Length



2BL-1	40X57	1	1400
2LG-1 *	40X114	1	224
2LG-2 *	40X114	1	352
2LG-3 *	40X114	1	480
2LG-4 *	40X114	1	567
2LG-5 *	40X114	1	737
2LG-6 *	40X114	1	866
2LG-7 *	40X114	1	994
2LG-8 *	40X114	1	1123
2LG-9 *	40X114	1	1251
2LG-10 *	40X114	1	1379
2LG-11 *	40X114	1	1400
2LG-12	40X114	21	1400

* Gable - delivered premounted

Wall A			
Mark	Profile	Count	Cut Length

ALG-1	40X114	11	4526
ALG-2	40X114	1	5686
ALG-3	40X114	1	5686
ALG-4	40X114	9	2144
ALG-5	40X114	9	873
ATL-1	40X143	1	2009
ATL-2	40X143	1	4077

Mark	Type	Profile	Count	Length
------	------	---------	-------	--------

CL1	Log 40X114		8	1929
CL2	Log 40X114		8	1929
CL3	Beam 40X70		2	1648

Cassidy Bunkie 40 (549x549)

List of all items 3

Wall 3			
Mark	Profile	Count	Cut Length

3BL-1	40X57	2	520
3LG-1 *	40X114	1	251
3LG-2 *	40X114	1	508
3LG-3 *	40X114	1	765
3LG-4 *	40X114	1	1022
3LG-5 *	40X114	1	1225
3LG-6 *	40X114	1	1535
3LG-7 *	40X114	1	1792
3LG-8 *	40X114	1	2049
3LG-9 *	40X114	1	2306
3LG-10 *	40X114	1	2487
3LG-11 *	40X114	1	2820
3LG-12 *	40X114	1	3076
3LG-13 *	40X114	1	3333
3LG-14 *	40X114	2	1445
3LG-15 *	40X114	2	1573
3LG-16 *	40X114	2	1660
3LG-17 *	40X114	2	1830
3LG-18 *	40X114	2	1959
3LG-19 *	40X114	2	2087
3LG-20 *	40X114	2	2216
3LG-21 *	40X114	2	2344
3LG-22 *	40X114	2	2472
3LG-23 *	40X114	1	5686
3LG-24	40X114	1	5686
3LG-25	40X114	1	5686
3LG-26	40X114	1	5686
3LG-27	40X114	36	520

Wall 4			
Mark	Profile	Count	Cut Length

4BL-1	40X57	1	5686
4LG-1 *	40X114	1	251
4LG-2 *	40X114	1	508
4LG-3 *	40X114	1	765
4LG-4 *	40X114	1	1022
4LG-5 *	40X114	1	1279
4LG-6 *	40X114	1	1535
4LG-7 *	40X114	1	1792
4LG-8 *	40X114	1	2049
4LG-9 *	40X114	2	880
4LG-10 *	40X114	2	1009
4LG-11 *	40X114	2	1137
4LG-12 *	40X114	2	1266
4LG-13 *	40X114	2	1394
4LG-14 *	40X114	1	3590
4LG-15 *	40X114	1	3847
4LG-16 *	40X114	1	4104
4LG-17 *	40X114	1	4361
4LG-18 *	40X114	1	4617
4LG-19 *	40X114	1	4874
4LG-20 *	40X114	1	5131
4LG-21 *	40X114	1	5388
4LG-22 *	40X114	1	5645
4LG-23 *	40X114	1	5686
4LG-24	40X114	1	5686
4LG-25	40X114	1	5686
4LG-26	40X114	10	5686
4LG-27	40X114	18	2073

* Gable - delivered premounted

Cassidy Bunkie 40 (549x549)

List of all items 4

Wall B			
Mark	Profile	Count	Cut Length

BLG-1	40X114	14	1400
BLG-2	40X114	1	1400
BLG-3	40X114	34	275
BTL-1	40X53	1	1400





Wall C			
Mark	Profile	Count	Cut Length

CLG-1	40X114	4	5686
CLG-2	40X114	9	3300
CLG-3	40X114	9	1616
CLG-4	40X114	8	5686
CLG-5	40X114	1	5686
CTL-1	40X143	1	2009
CTL-2	40X143	1	4077



Columns			
Mark	Profile	Count	Length

CM	Post 80x70	1	2184
----	------------	---	------

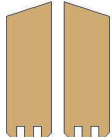
Log profiles	
Profile	Profile

40X57	
40X53	
40X114	
40X114	
40X143	

Stairs				
Mark	Profile	Profile	Count	Cut Length

ST1L	Stair 40X120		1	2577
ST1R	Stair 40X120		1	2577
ST2	Stair 40X143		10	520

Fence Schedule		
Type	Length	Count

Fence	1593	1
-------	------	---

Windboard

① Windboard Assembly 1



② Windboard Assembly 2

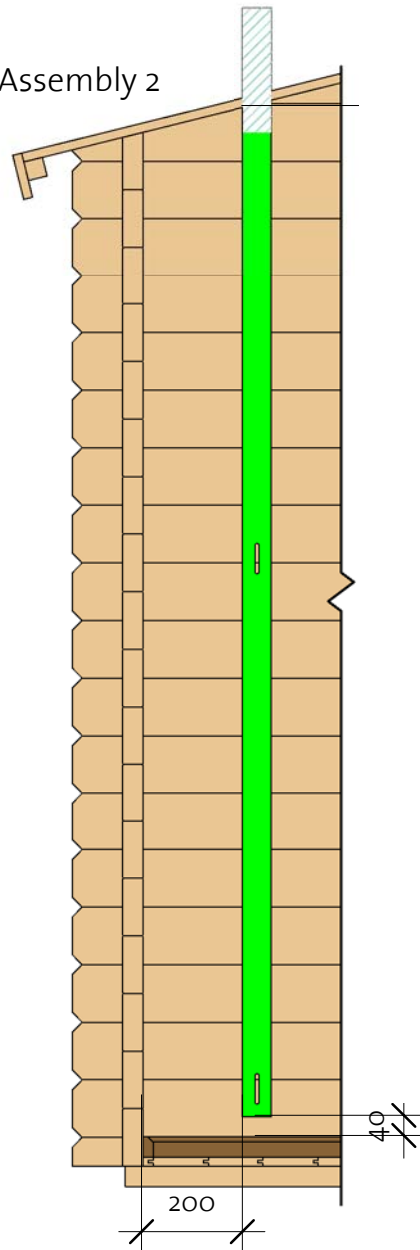

③ Windboard Assembly 3

