

# Colorado 28 (107 7/8" x 131 7/8")

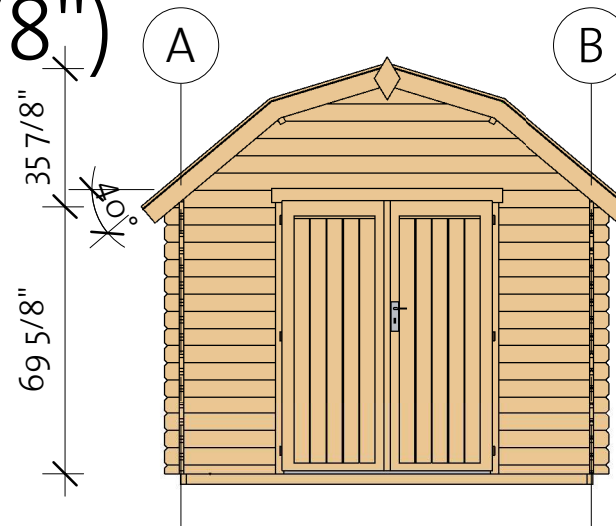

# Colorado 28 (107 7/8" x 131 7/8")

Foundation

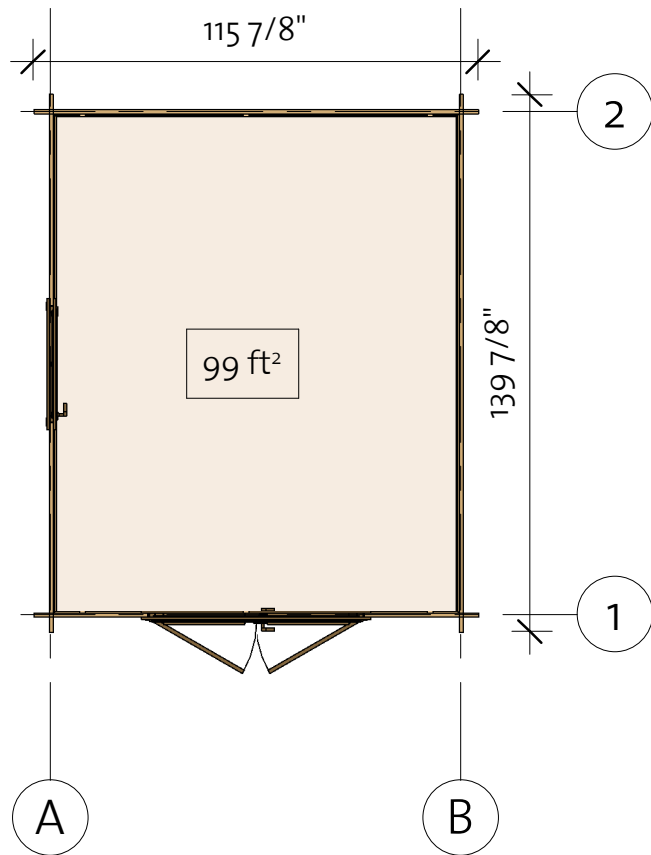
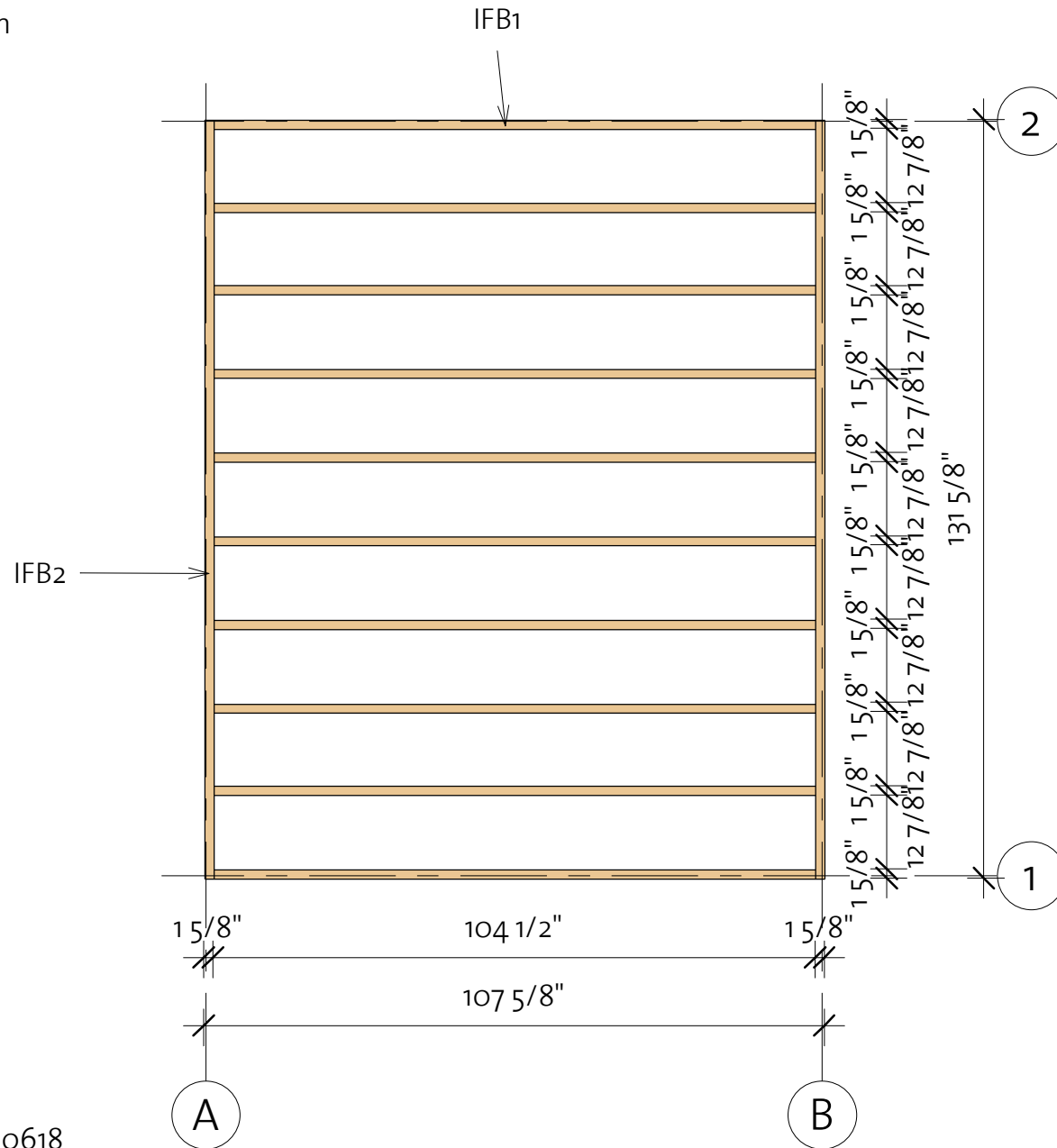

Impregnated foundation beams				
Mark	Type	Profile	Count	Length

IFB1	IFB 40x70		10	104 1/2"
IFB2	IFB 40x70		2	131 5/8"

# Colorado 28 (107 7/8" x 131 7/8")

Floor Plan

① Baseboard

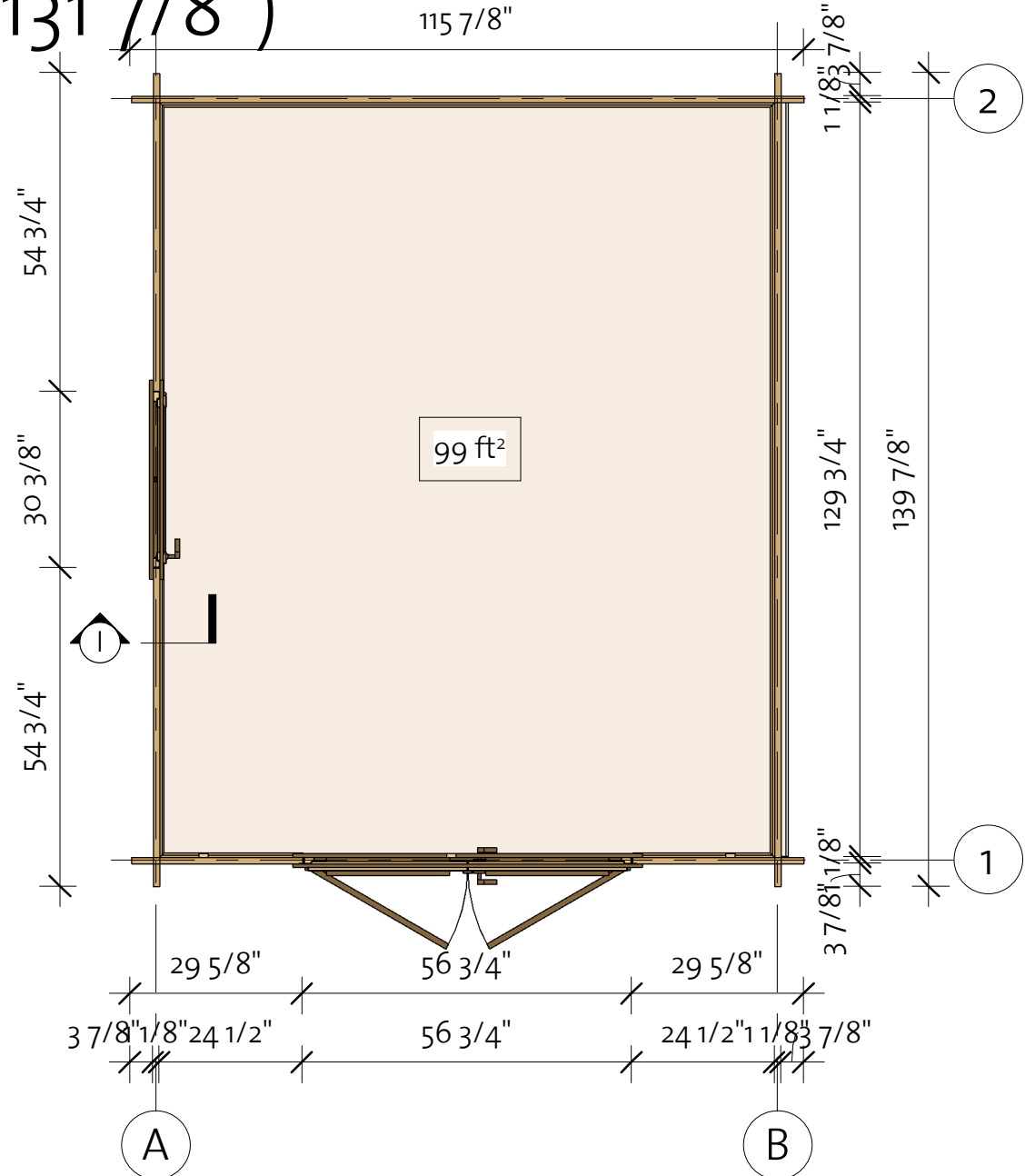
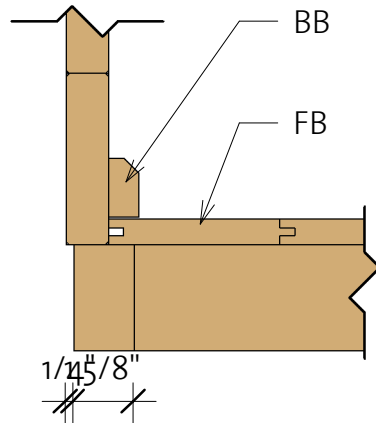

Floor Schedule

Mark	Type	Profile	Count	Length
------	------	---------	-------	--------

FB	FB 17x114		25	129 5/8"
----	-----------	---	----	----------

BB1	BB 20x40		2	129 7/8"
BB2	BB 20x40		2	106 1/4"

# Colorado 28 (107 7/8" x 131 7/8")

Wall 1

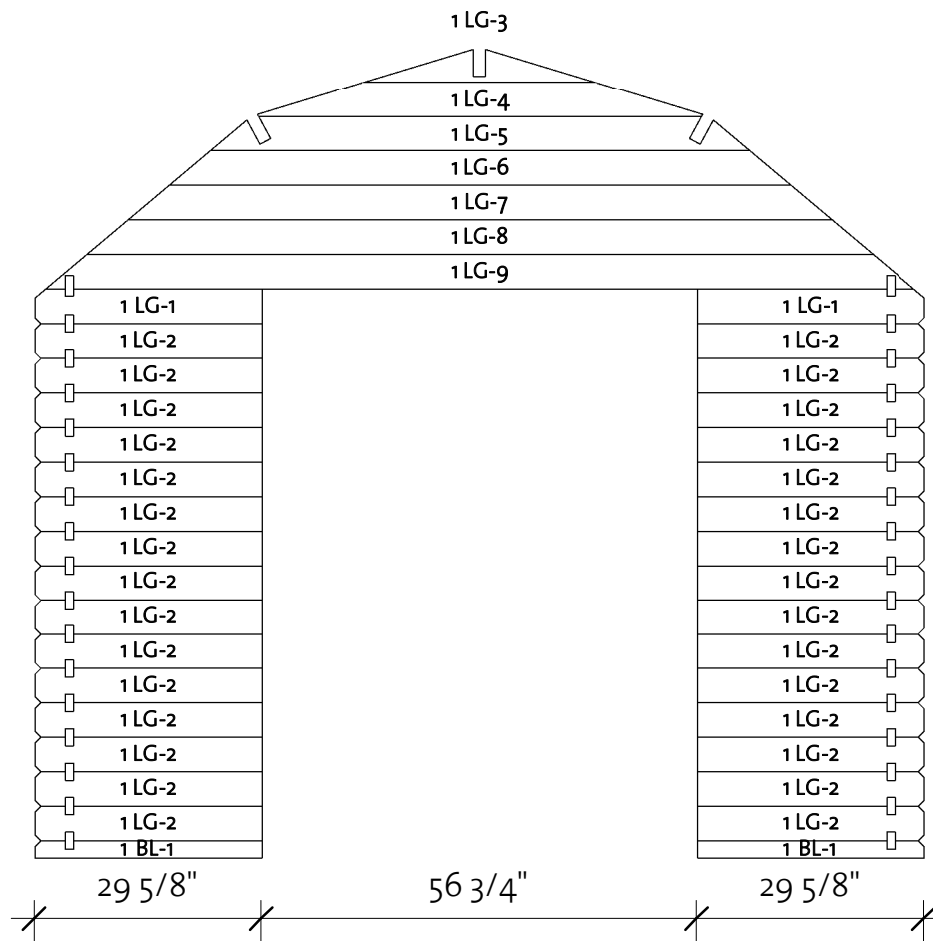
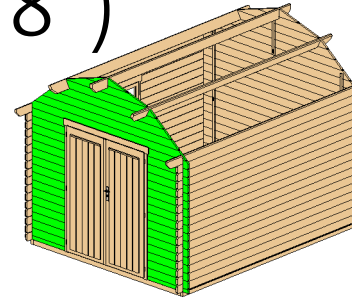

Wall 1			
Mark	Profile	Count	Cut Length

1BL-1	28x57	2	29 5/8"
1LG-1	28x114	2	29 5/8"
1LG-2	28x114	30	29 5/8"
1LG-3 *	28x114	1	30"
1LG-4 *	28x114	1	58"
1LG-5**	28x114	1	70 1/4"
1LG-6**	28x114	1	80 7/8"
1LG-7**	28x114	1	91 5/8"
1LG-8**	28x114	1	102 3/8"
1LG-9**	28x114	1	113"

\* Gable 1 - delivered premounted  
 \*\* Gable 2 - delivered premounted

Log Profile Wall 1	
Profile	Profile

28x57	
28x114	

# Colorado 28 (107 7/8" x 131 7/8")

Wall 2

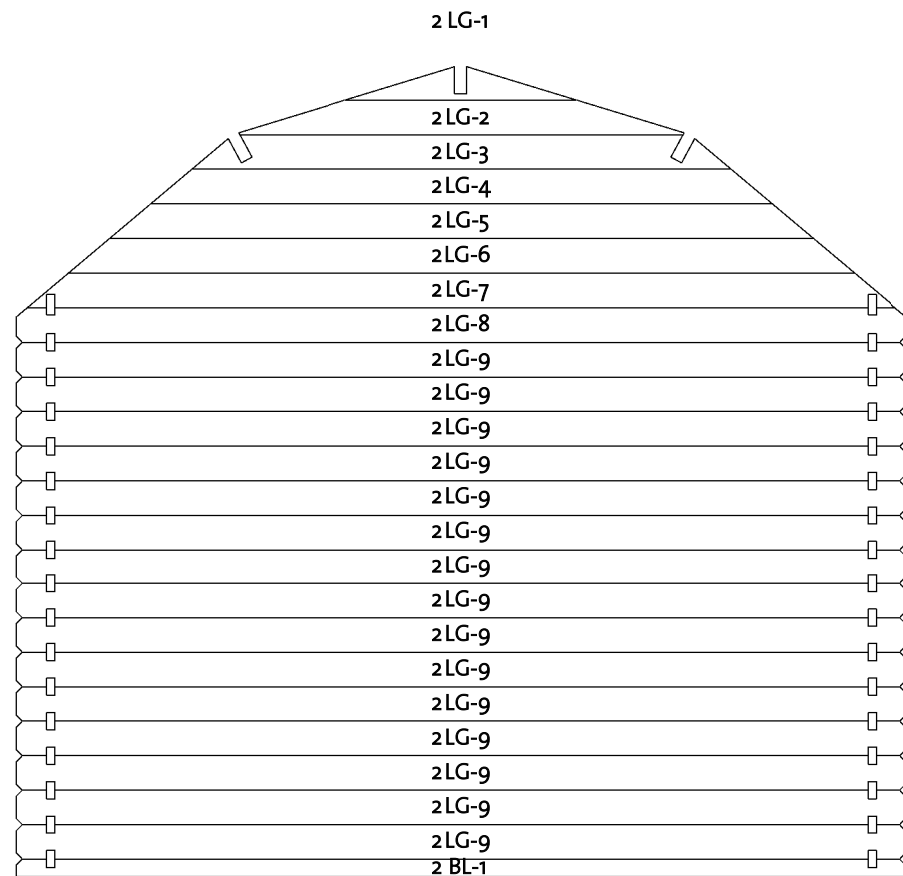
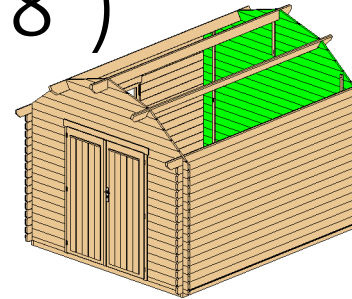

115 7/8"

91808178\_210618

Wall 2			
Mark	Profile	Count	Cut Length

2BL-1	28x57	1	115 7/8"
2LG-1*	28x114	1	30"
2LG-2*	28x114	1	58"
2LG-3**	28x114	1	70 1/4"
2LG-4**	28x114	1	80 7/8"
2LG-5**	28x114	1	91 5/8"
2LG-6**	28x114	1	102 3/8"
2LG-7**	28x114	1	113"
2LG-8	28x114	1	115 7/8"
2LG-9	28x114	15	115 7/8"

\* Gable 1 - delivered premounted  
 \*\* Gable 2 - delivered premounted

Log Profile Wall 2	
Profile	Profile

28x57	
28x114	

# Colorado 28 (107 7/8" x 131 7/8")

Wall A

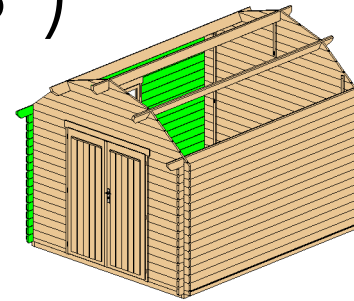

Wall A			
Mark	Profile	Count	Cut Length

ALG-1	28x114	18	54 3/4"
ALG-2	28x114	7	139 7/8"
ATL-1	28x123	1	151 3/4"

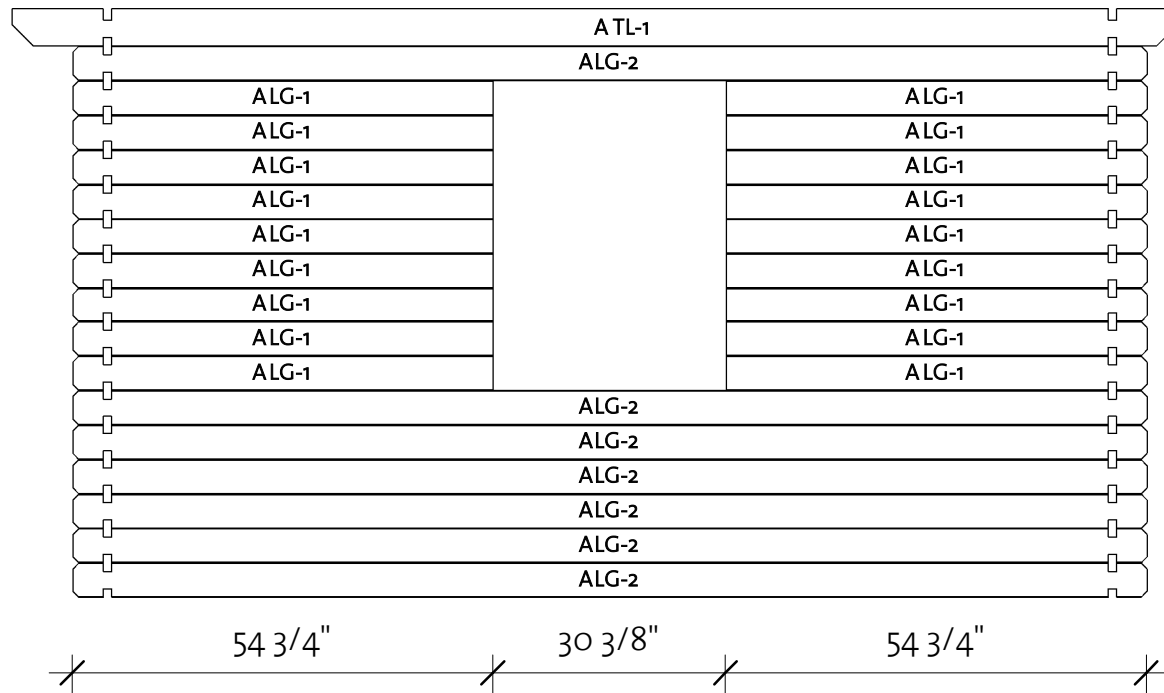

Log Profile Wall A	
Profile	Profile

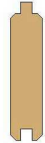
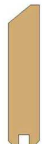
28x114	
28x123	

# Colorado 28 (107 7/8" x 131 7/8")

Wall B

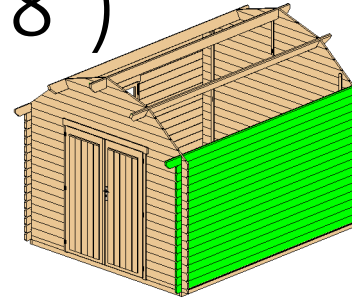

Wall B			
Mark	Profile	Count	Cut Length

BLG-1	28x114	16	139 7/8"
BTL-1	28x123	1	151 3/4"

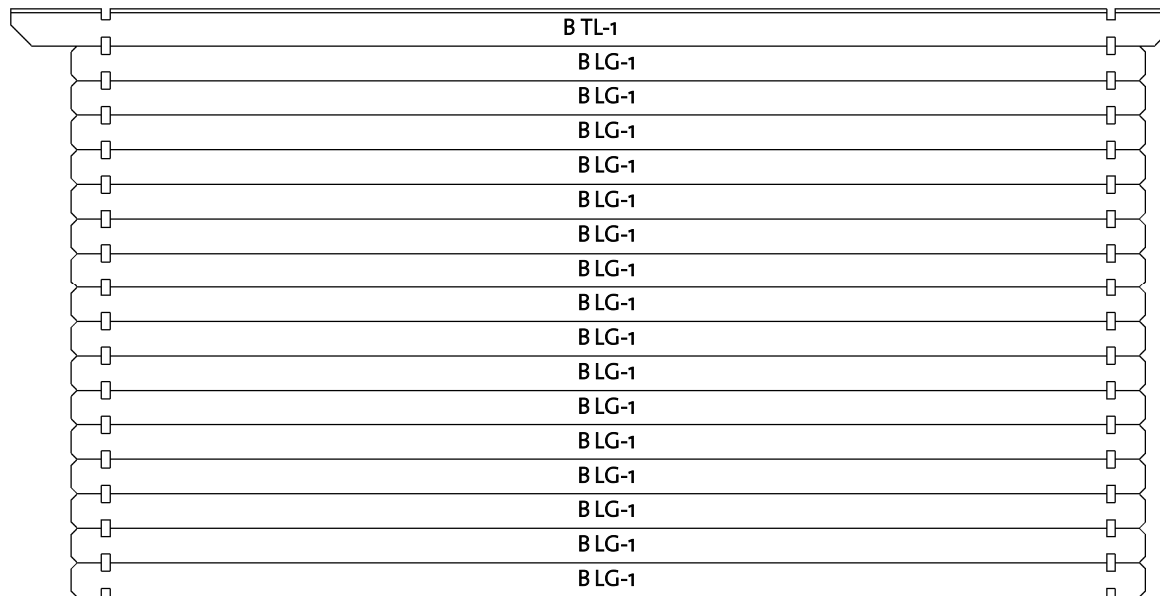

139 7/8"

91808178\_210618





Log Profile Wall B	
Profile	Profile

28x114	
28x123	

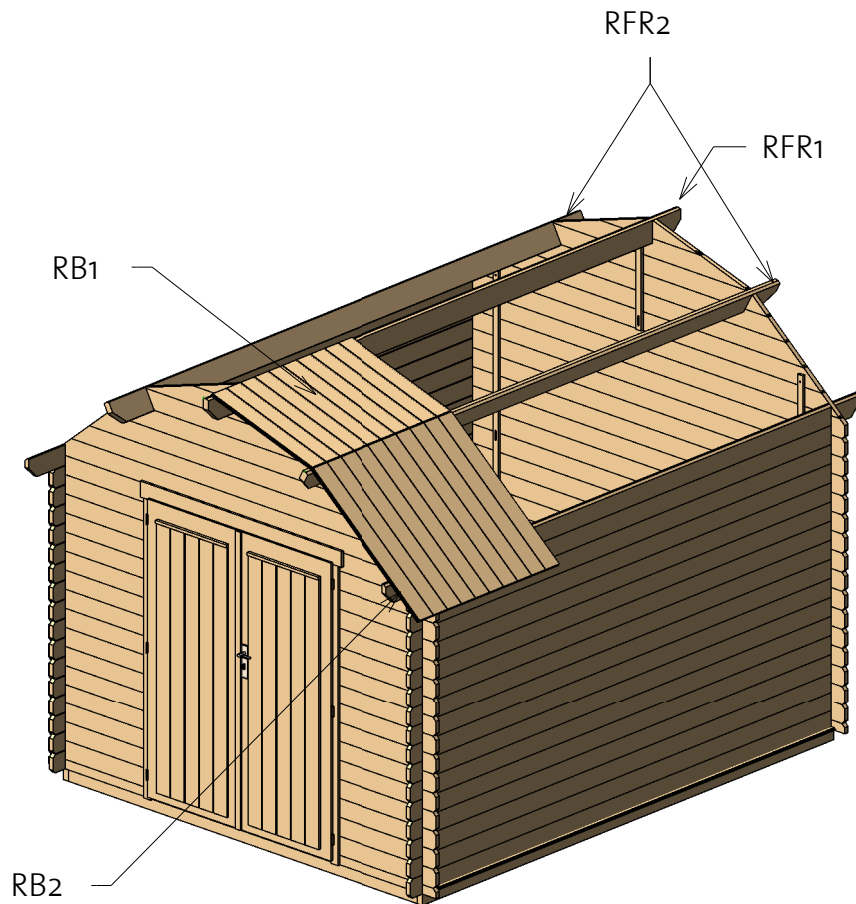
# Colorado 28 (107 7/8" x 131 7/8")

Roof 1



Roof				
Mark	Type	Profile	Count	Length
RFR1	Ridge 40x143		1	151 3/4"
RFR2	Ridge 40x143		2	151 3/4"
RB1	17x114		68	31 1/8"
RB2	17x114		68	41 7/8"



# Colorado 28 (107 7/8" x 131 7/8")

Roof 2

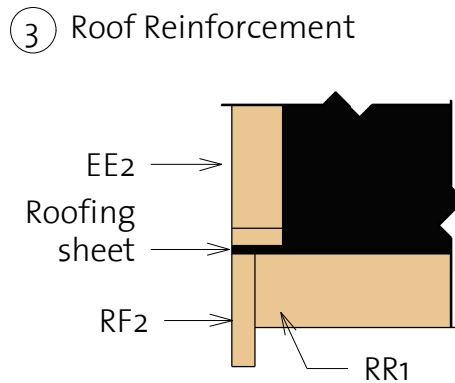
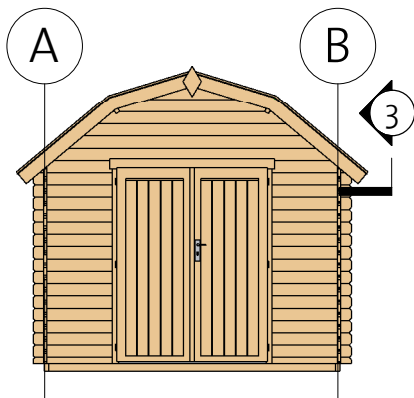
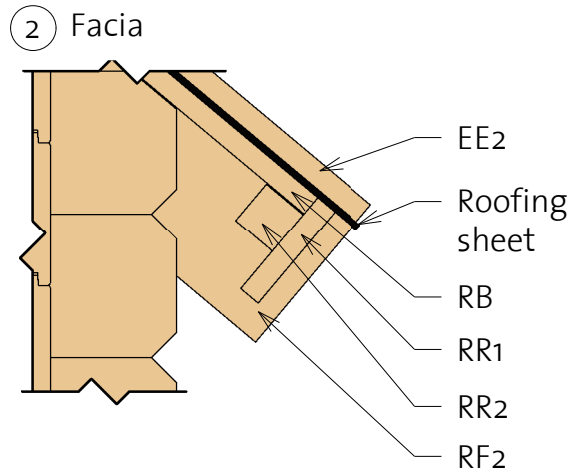
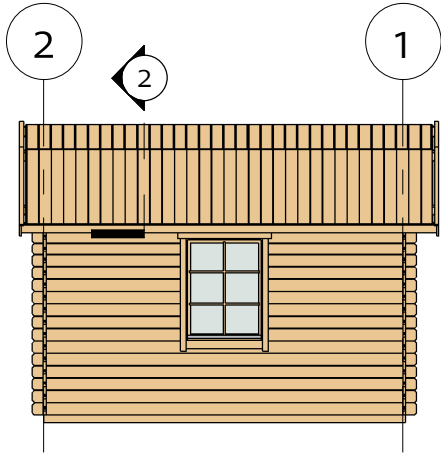

Fascia Schedule				
Mark	Type	Profile	Count	Length
EE1	Eave Edging 18x40		4	31 1/2"
EE2	Eave Edging 18x40		4	43 1/2"
RF1	Roof Fascia 18x120		4	31 1/2"
RF2	Roof Fascia 18x120		4	43 1/2"
RR1	Roof reinforcement 18x95		2	151 3/4"
RR2	Roof reinforcement 38x38		2	151 3/4"

# Colorado 28 (107 7/8" x 131 7/8")

Extras

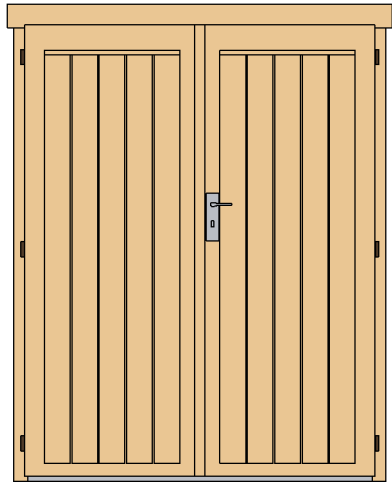

Door Schedule				
Mark	Type	Width	Height	Count
BDD6R	Basic double door 6, wood right	56 1/8"	72 1/4"	1

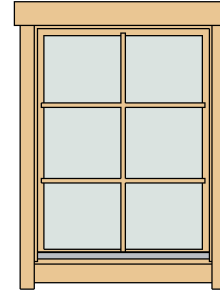

Window Schedule				
Mark	Type	Width	Height	Count
BW1R	Basic window 1 right	30 1/8"	39"	1
WCB6	Windows Crossbar 6	--	--	1

Fasteners & Extras		
Name	Type	Count
Hitblock	300-400 mm	
Screws	5,0 x 70	15
Bolt	M8 x 60	16
Nails	1,4 x 40	40
Screws	6,0 x 140	60
Screws	4,0 x 40	690

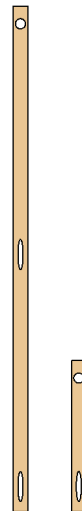



Type	Count	Length
Windboard1 18x40	4	79 1/8"
Windboard 2 18x40	2	23 5/8"

Type	Count
Romb	2





# Colorado 28 (107 7/8"x131 7/8")

## List of all items 1

### Impregnated foundation beams

Mark	Type	Profile	Count	Length
IFB1	IFB 40x70		10	104 1/2"
IFB2	IFB 40x70		2	131 5/8"

### Roof







Mark	Type	Profile	Count	Length
RFR1	Ridge 40x143		1	151 3/4"
RFR2	Ridge 40x143		2	151 3/4"
RB1	17x114		68	31 1/8"
RB2	17x114		68	41 7/8"

91808178\_210618

### Floor Schedule

Mark	Type	Profile	Count	Length
FB	FB 17x114		25	129 5/8"
BB1	BB 20x40		2	129 7/8"
BB2	BB 20x40		2	106 1/4"

### Fascia Schedule

Mark	Type	Profile	Count	Length
EE1	Eave Edging 18x40		4	31 1/2"
EE2	Eave Edging 18x40		4	43 1/2"
RF1	Roof Fascia 18x120		4	31 1/2"
RF2	Roof Fascia 18x120		4	43 1/2"
RR1	Roof reinforcement 18x95		2	151 3/4"
RR2	Roof reinforcement 38x38		2	151 3/4"

# Colorado 28 (107 7/8"x131 7/8")

## List of all items 2

Wall 1			
Mark	Profile	Count	Cut Length

1BL-1	28x57	2	29 5/8"
1LG-1	28x114	2	29 5/8"
1LG-2	28x114	30	29 5/8"
1LG-3 *	28x114	1	30"
1LG-4 *	28x114	1	58"
1LG-5**	28x114	1	70 1/4"
1LG-6**	28x114	1	80 7/8"
1LG-7**	28x114	1	91 5/8"
1LG-8**	28x114	1	102 3/8"
1LG-9**	28x114	1	113"

Wall 2			
Mark	Profile	Count	Cut Length

2BL-1	28x57	1	115 7/8"
2LG-1*	28x114	1	30"
2LG-2*	28x114	1	58"
2LG-3**	28x114	1	70 1/4"
2LG-4**	28x114	1	80 7/8"
2LG-5**	28x114	1	91 5/8"
2LG-6**	28x114	1	102 3/8"
2LG-7**	28x114	1	113"
2LG-8	28x114	1	115 7/8"
2LG-9	28x114	15	115 7/8"

Wall A			
Mark	Profile	Count	Cut Length

ALG-1	28x114	18	54 3/4"
ALG-2	28x114	7	139 7/8"
ATL-1	28x123	1	151 3/4"



\* Gable 1 - delivered premounted

Wall B			
Mark	Profile	Count	Cut Length

BLG-1	28x114	16	139 7/8"
BTL-1	28x123	1	151 3/4"

\*\* Gable 2 - delivered premounted

Log Profiles	
Profile	Profile

28x57	
28x114	

Log Profiles	
Profile	Profile

28x123	
--------	---