

Colwood Bunkie 40 (131 7/8"x117 3/4")

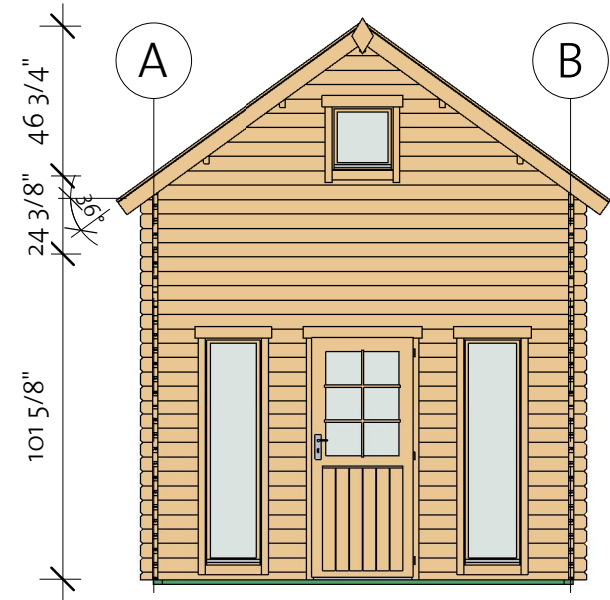
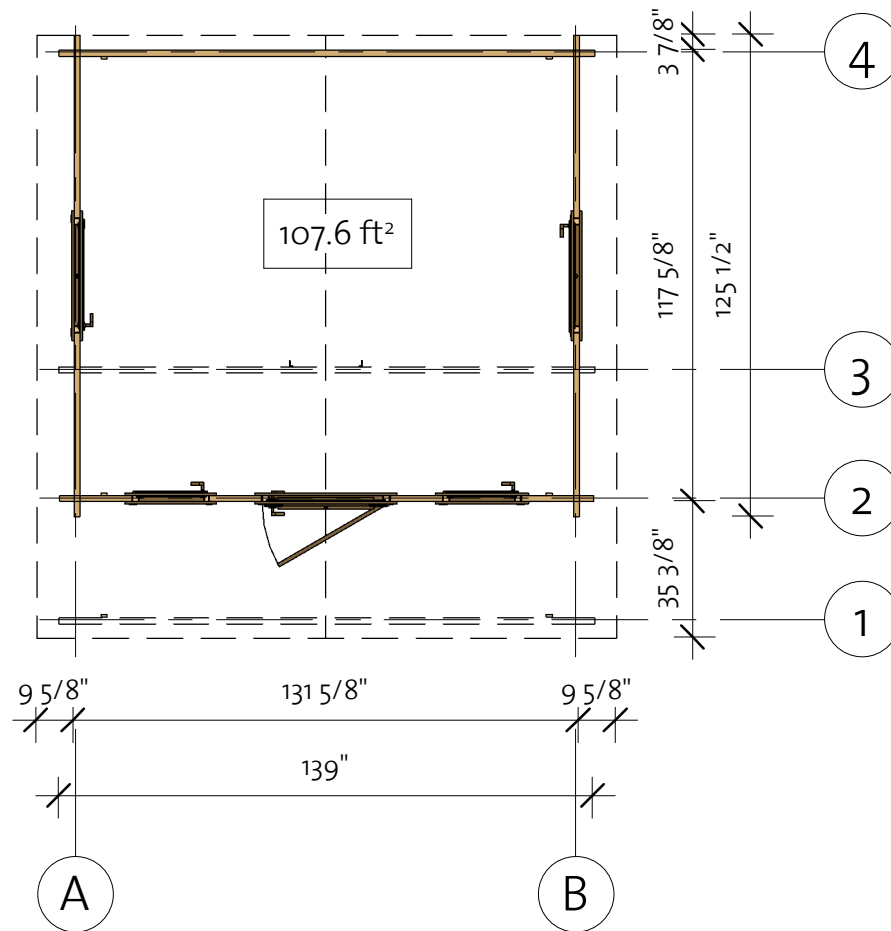

EZ Log Structures
Do-It-Yourself Building Kits

Colwood Bunkie 40 (131 7/8"x117 3/4")

Foundation

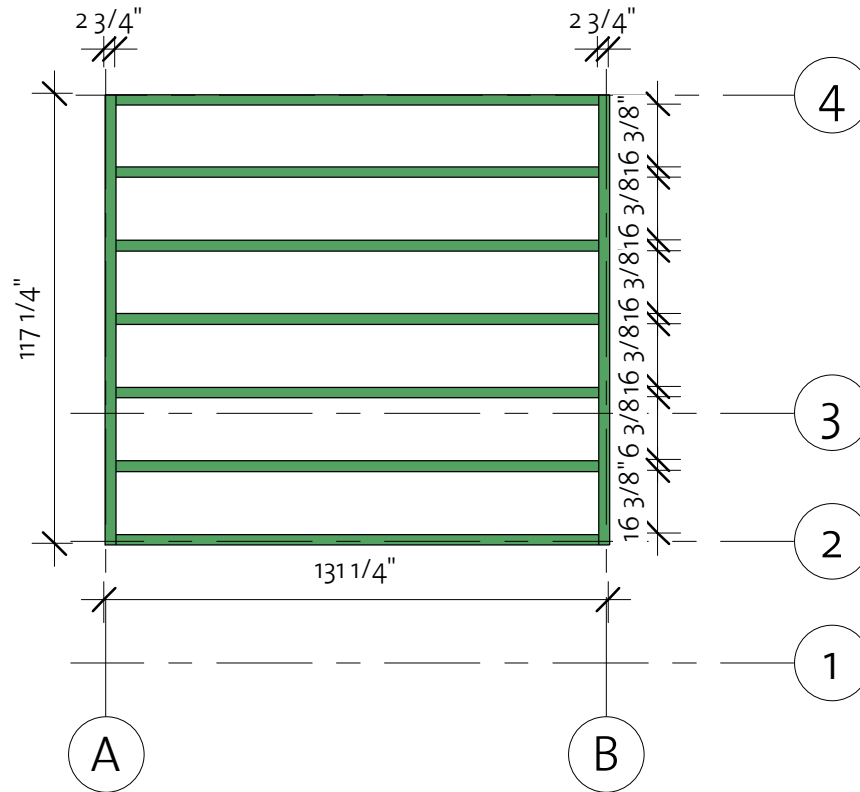

Impregnated foundation beams				
Mark	Type	Profile	Count	Length
IFB1	IFB 70x40		2	117 1/4"
IFB2	IFB 70x40		7	125 3/4"

Colwood Bunkie 40 (131 7/8"x117 3/4")

Floor Plan

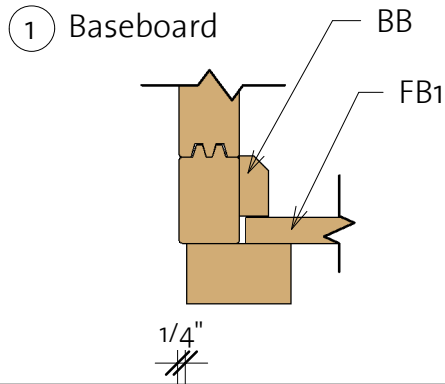

Floor Schedule

Mark	Type	Profile	Count	Length
FB1	FB 17x114		30	114 1/8"
FB2	FB 17x114		30	64 3/4"
BB1	BB 20x40		3	131 7/8"
BB2	BB 20x40		3	118 1/8"

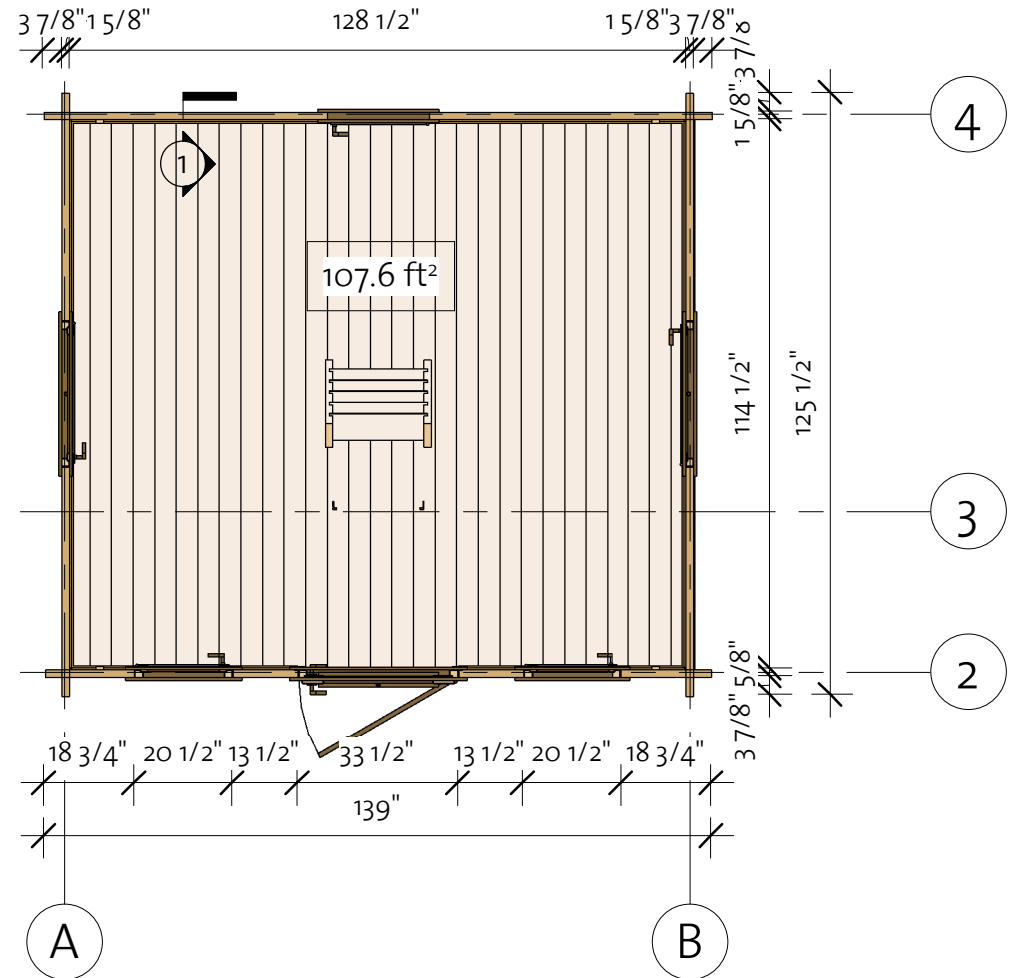

Colwood Bunkie 40 (131 7/8"x117 3/4")

Wall 1

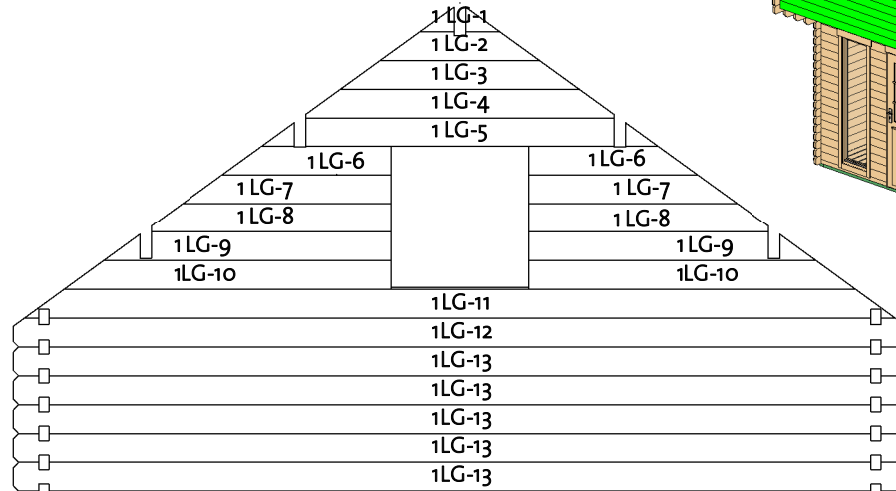
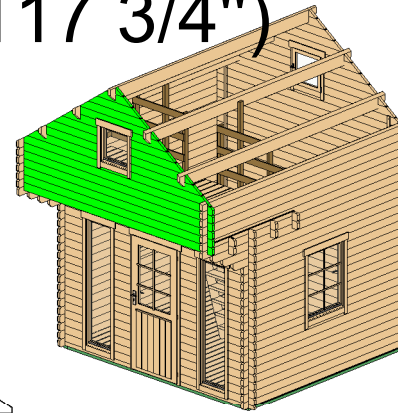

Wall 1			
Mark	Profile	Count	Cut Length

1LG-1 *	40X114	1	12 3/8"
1LG-2 *	40X114	1	24 3/4"
1LG-3 *	40X114	1	37 1/8"
1LG-4 *	40X114	1	48 1/8"
1LG-5 *	40X114	1	61 7/8"
1LG-6 *	40X114	2	26 3/8"
1LG-7 *	40X114	2	32 5/8"
1LG-8 *	40X114	2	37 1/2"
1LG-9 *	40X114	2	45"
1LG-10*	40X114	2	51 1/8"
1LG-11 *	40X114	1	136 1/8"
1LG-12 *	40X114	1	139 1/2"
1LG-13	40X114	5	139 1/2"

* Gable - delivered premounted

Log Profile Wall 1	
Profile	Profile

40X114	
--------	---

Colwood Bunkie 40 (131 7/8"x117 3/4")

Wall 2

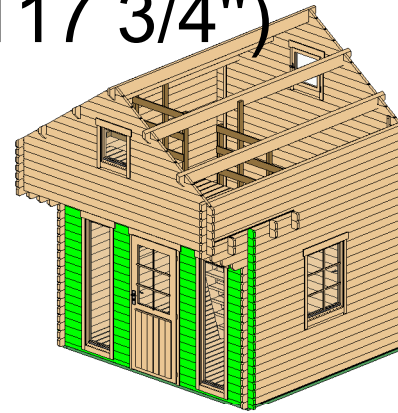

Wall 2

Mark	Profile	Count	Cut Length
------	---------	-------	------------

2BL-1	40X57	2	53"
2LG-1	40X114	34	13 1/2"
2LG-2	40X114	34	19"
2LG-3	40X114	4	139 1/2"
2LG-4	40X114	1	139 1/2"

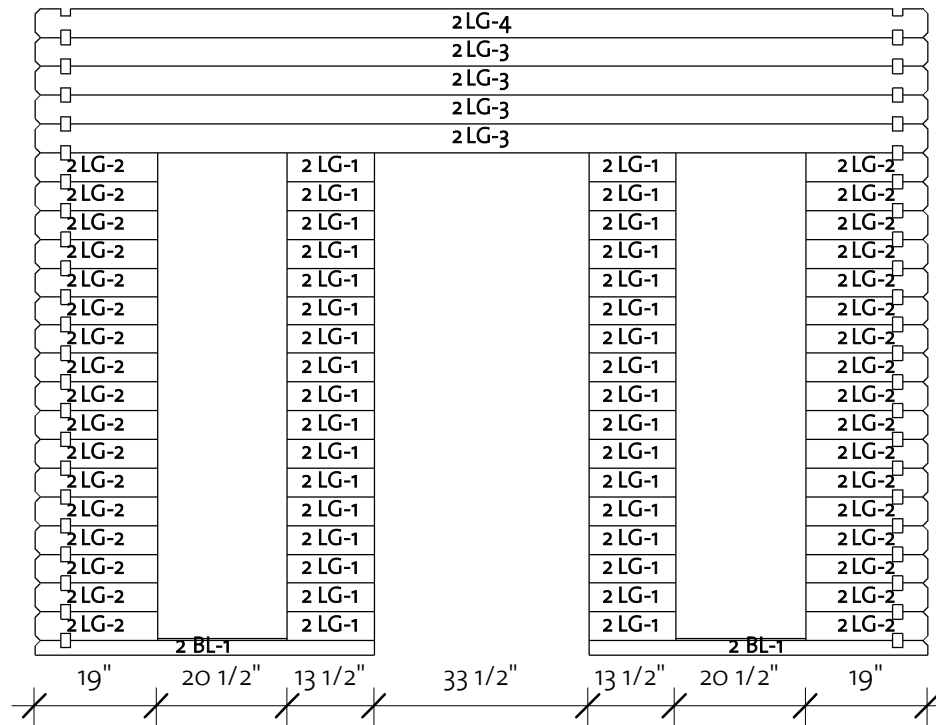

Log Profile Wall 2

Profile	Profile
---------	---------

40X57



40X114



Colwood Bunkie 40 (131 7/8"x117 3/4")

Wall 3

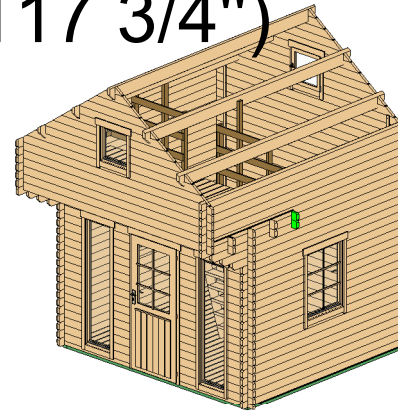

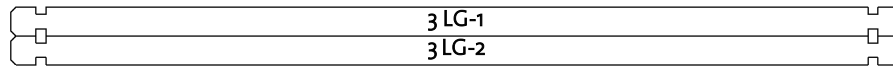

Wall 3			
Mark	Profile	Count	Cut Length

3LG-1	40X114	1	139 1/2"
3LG-2	40X114	1	139 1/2"



Log Profile Wall 3	
Profile	Profile

40X114	
40X114	

Colwood Bunkie 40 (131 7/8"x117 3/4")

Wall 4

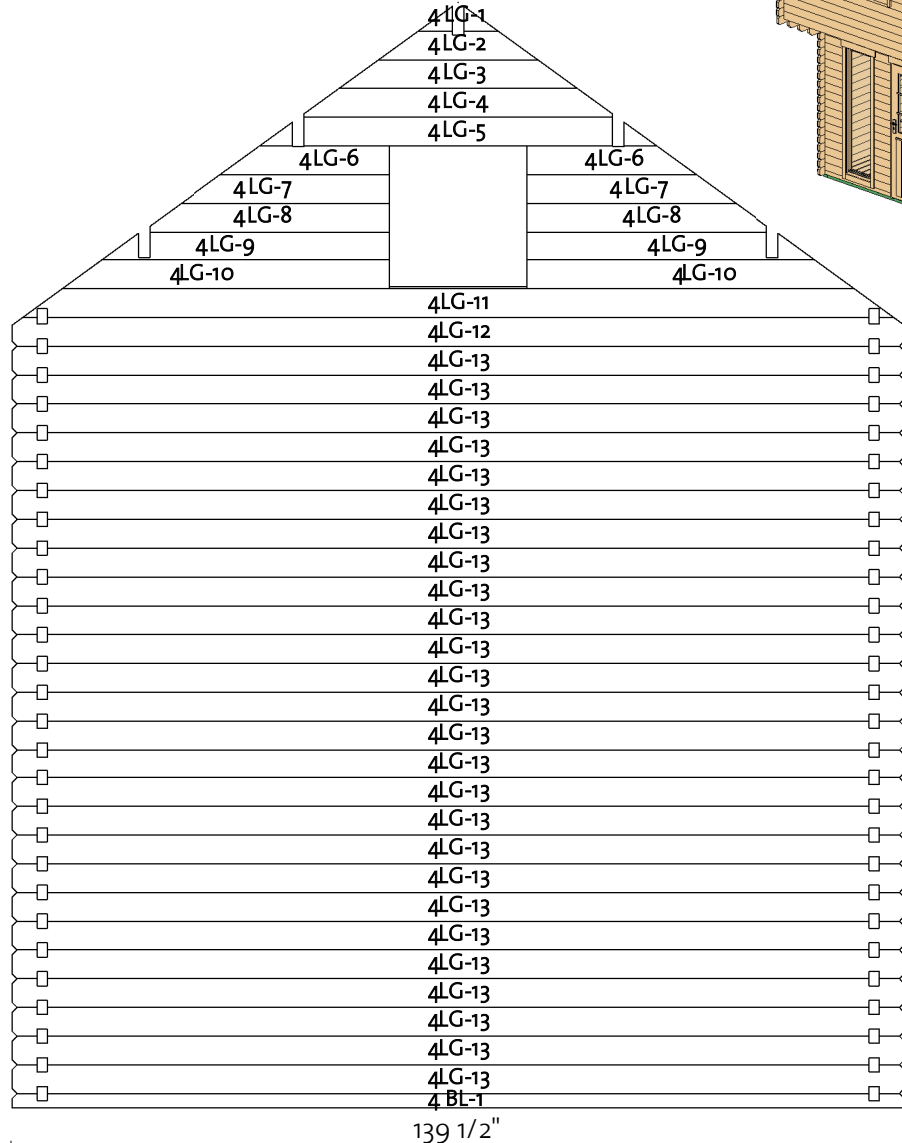
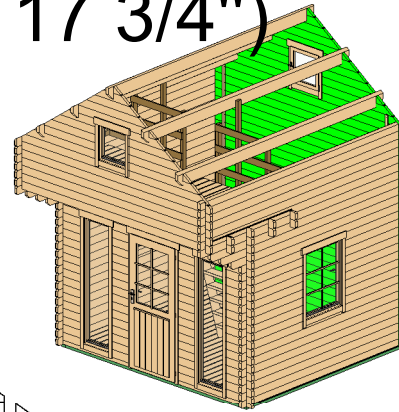

Wall 4			
Mark	Profile	Count	Cut Length

4BL-1	40X57	1	139 1/2"
4LG-1 *	40X114	1	12 3/8"
4LG-2 *	40X114	1	24 3/4"
4LG-3 *	40X114	1	37 1/8"
4LG-4 *	40X114	1	48 1/8"
4LG-5 *	40X114	1	61 7/8"
4LG-6 *	40X114	2	26 3/8"
4LG-7 *	40X114	2	32 5/8"
4LG-8 *	40X114	2	37 1/2"
4LG-9 *	40X114	2	45"
4LG-10 *	40X114	2	51 1/8"
4LG-11 *	40X114	1	136 1/8"
4LG-12 *	40X114	1	139 1/2"
4LG-13	40X114	26	139 1/2"

* Gable - delivered premounted

Log Profile Wall 4	
Profile	Profile

40X57	
40X114	

Colwood Bunkie 40 (131 7/8"x117 3/4")

Wall A

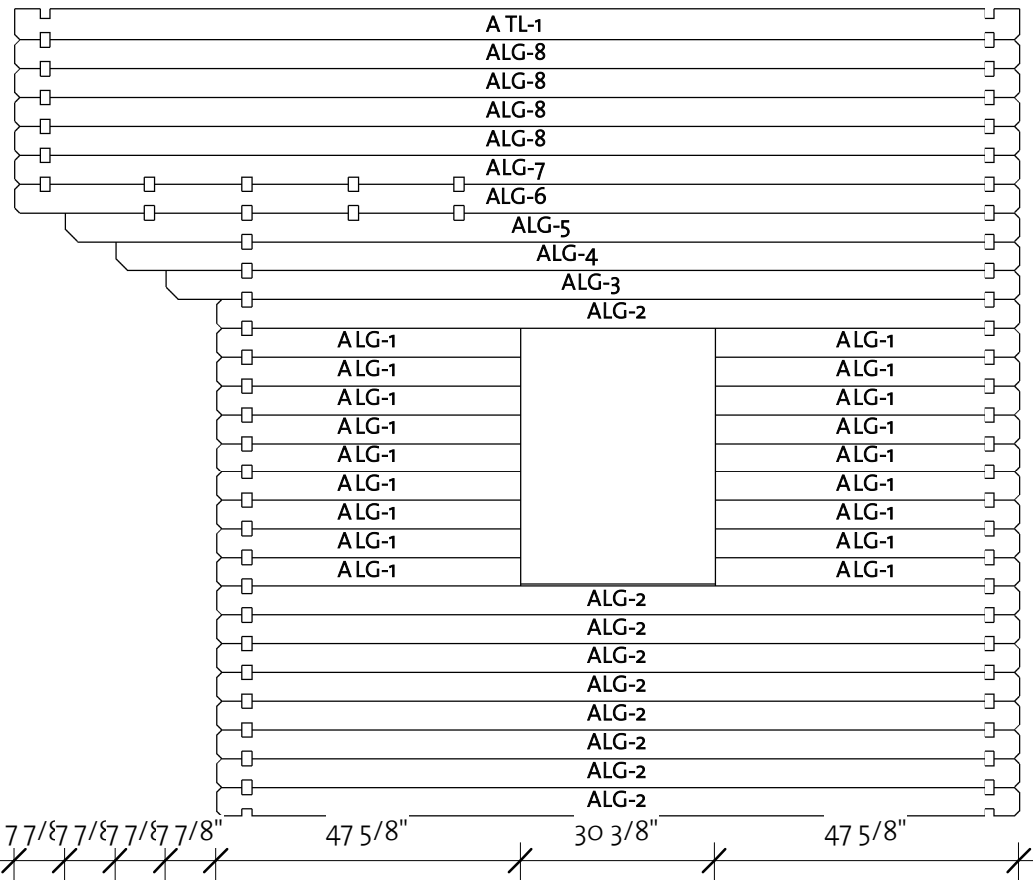
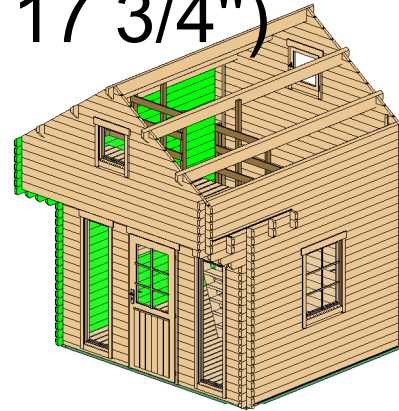

Wall A			
Mark	Profile	Count	Cut Length

ALG-1	40X114	18	47 5/8"
ALG-2	40X114	9	125 1/2"
ALG-3	40X114	1	133 3/8"
ALG-4	40X114	1	141 1/4"
ALG-5	40X114	1	149 1/8"
ALG-6	40X114	1	157"
ALG-7	40X114	1	157"
ALG-8	40X114	4	157"
ATL-1	40X123	1	157"

Log Profile Wall A	
Profile	Profile

40X114	
40X123	

Colwood Bunkie 40 (131 7/8"x117 3/4")

Wall B

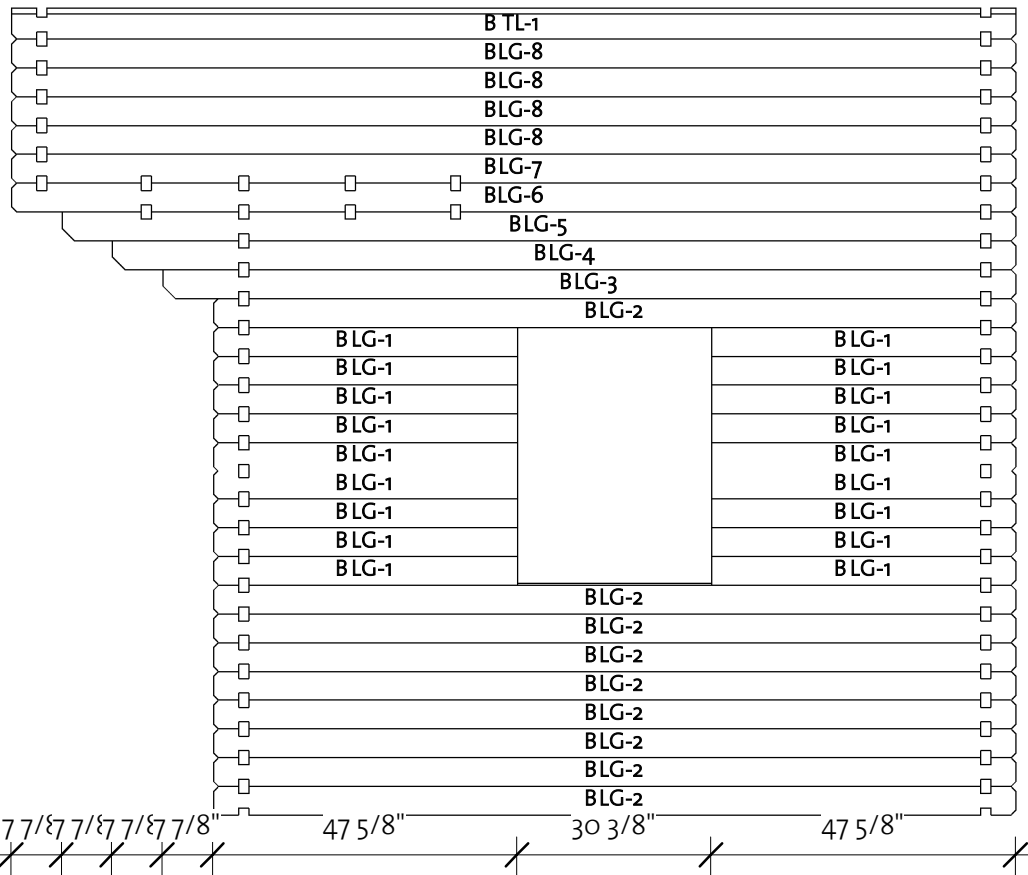
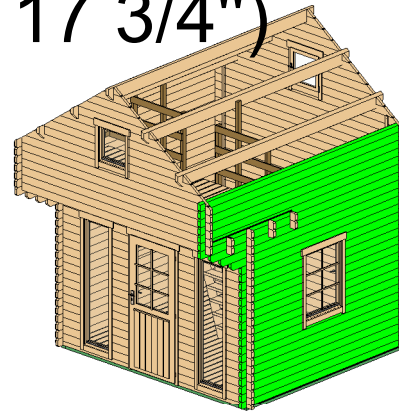

92309152_230915

Wall B			
Mark	Profile	Count	Cut Length

BLG-1	40X114	18	47 5/8"
BLG-2	40X114	9	125 1/2"
BLG-3	40X114	1	133 3/8"
BLG-4	40X114	1	141 1/4"
BLG-5	40X114	1	149 1/8"
BLG-6	40X114	1	157"
BLG-7	40X114	1	157"
BLG-8	40X114	4	157"
BTL-1	40X123	1	157"



Log Profile Wall B	
Profile	Profile

40X114	
40X123	

Colwood Bunkie 40 (131 7/8"x117 3/4")

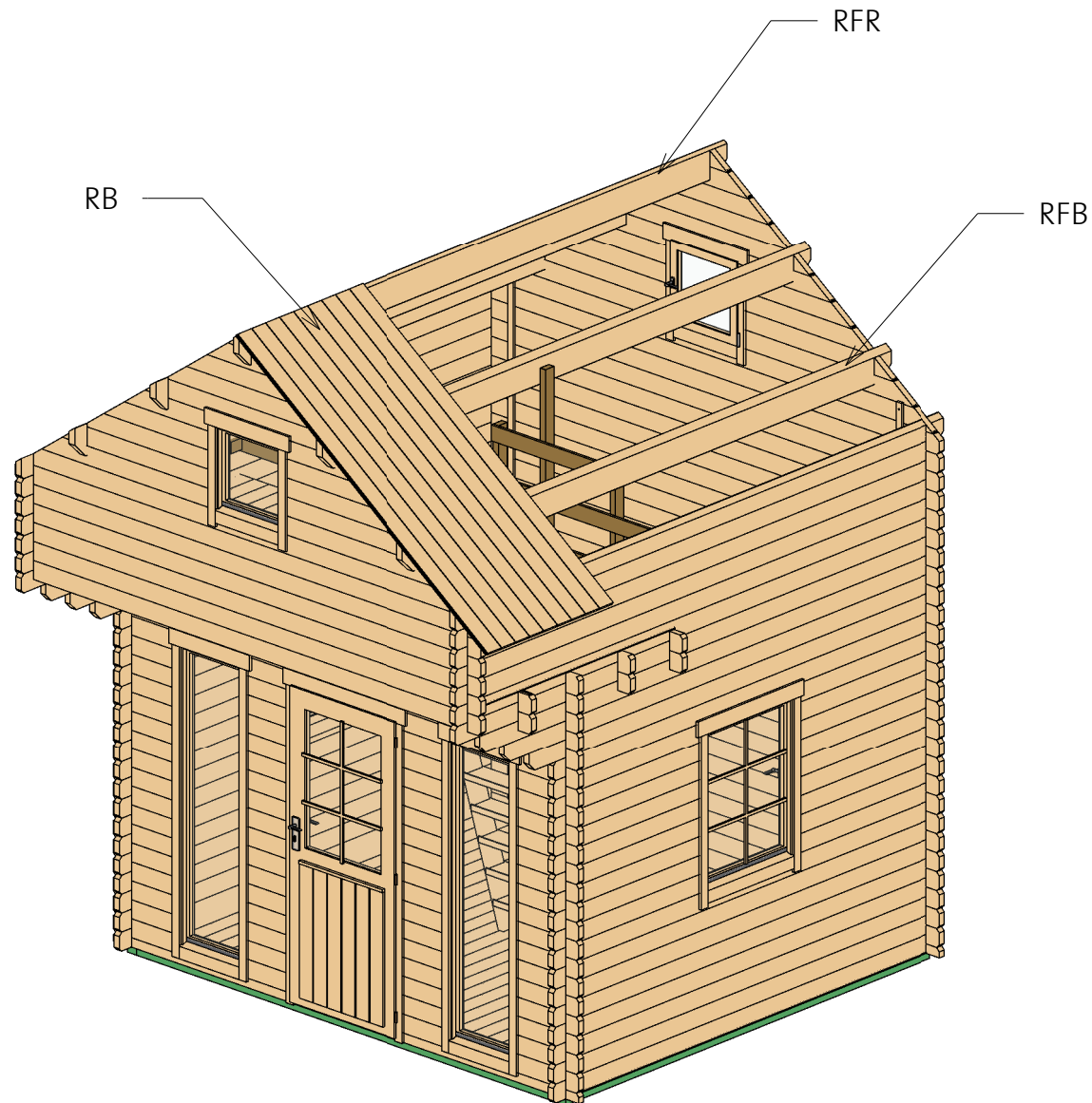
Roof 1



Roof				
Mark	Type	Profile	Count	Length
RFR	Ridge 45x195		1	157"
RFB	Beam 45x195		4	157"
RB	17x114		72	93 1/4"

Colwood Bunkie 40 (131 7/8"x117 3/4")

Roof 2

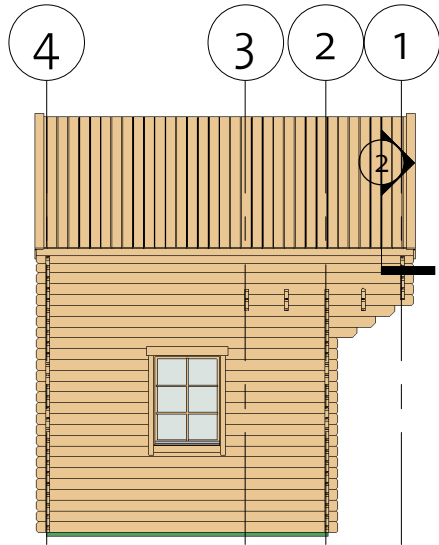

② Facia

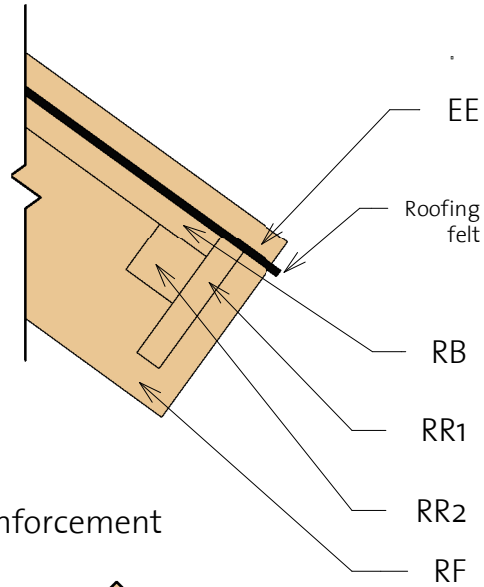

③ Roof Reinforcement

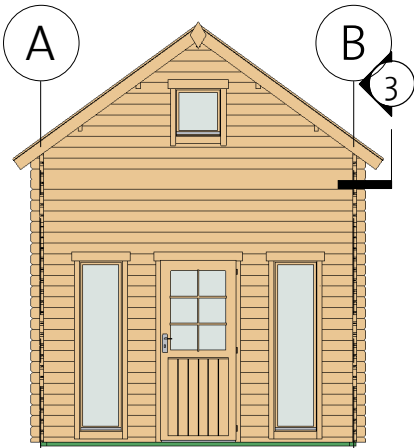
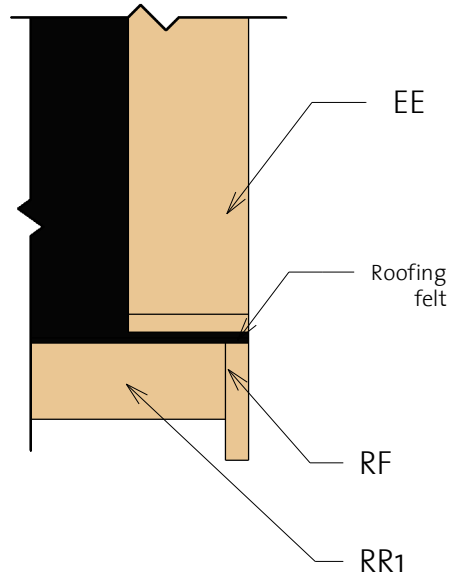



Fascia Schedule

Mark	Type	Profile	Count	Length
EE	Eave Edging 18x95		4	94 3/4"
RF	Roof Fascia 18x120		4	94 3/4"
RR1	Roof reinforce ment 18x95		2	157"
RR2	Roof reinforce ment 38x38		2	157"

Colwood Bunkie 40 (131 7/8"x117 3/4")

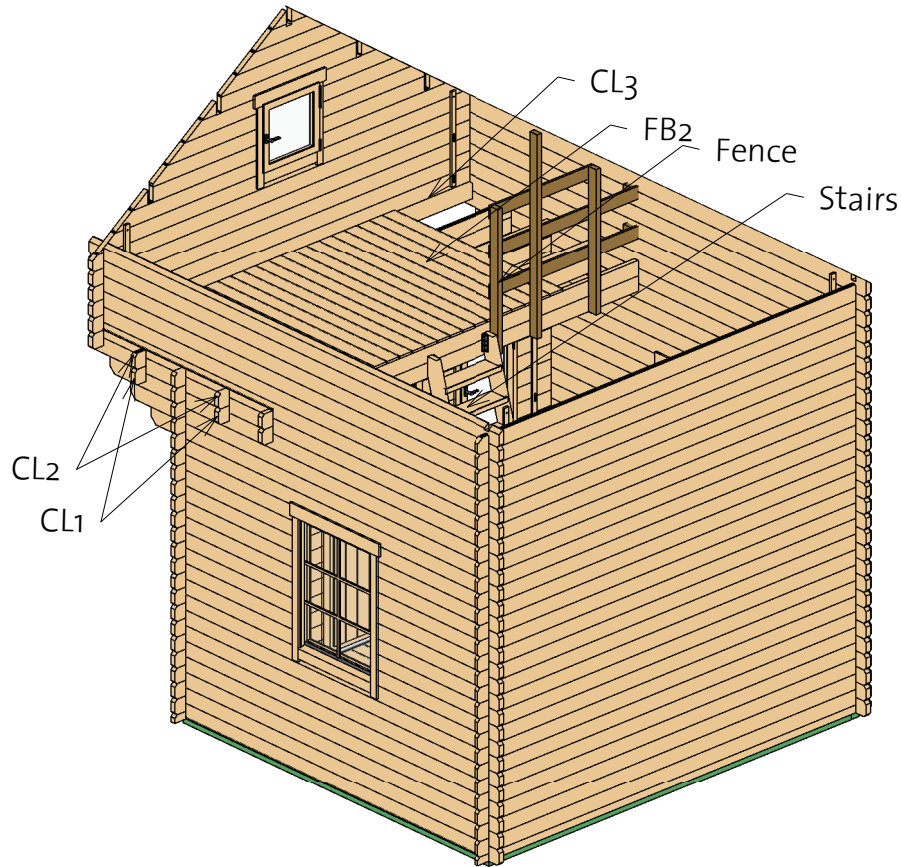
Second floor (58 ft²)

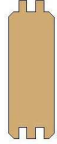



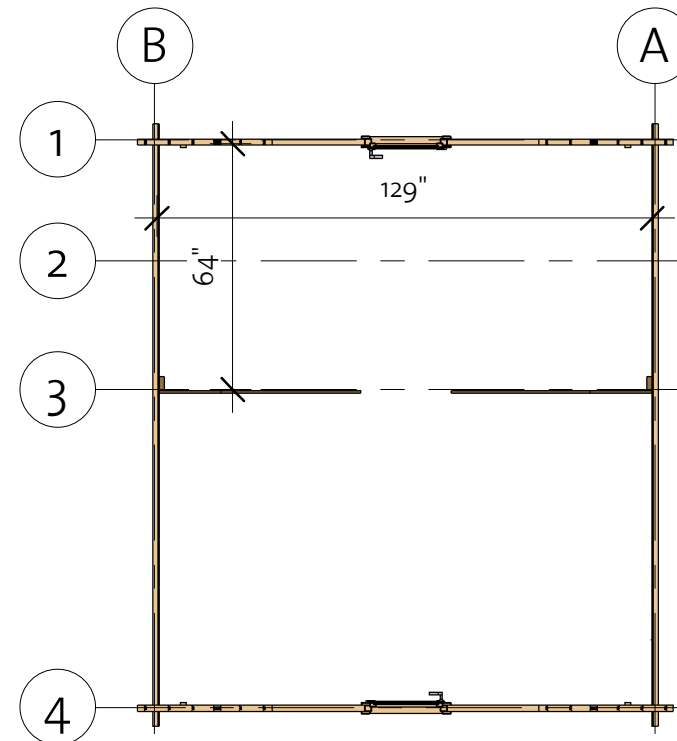

Second floor schedule				
Mark	Type	Profile	Length	Count
CL1	Log 4OX114		139 1/2"	2
CL2	Log 4OX114		139 1/2"	2
CL3	Log 4OX114		128 3/8"	1

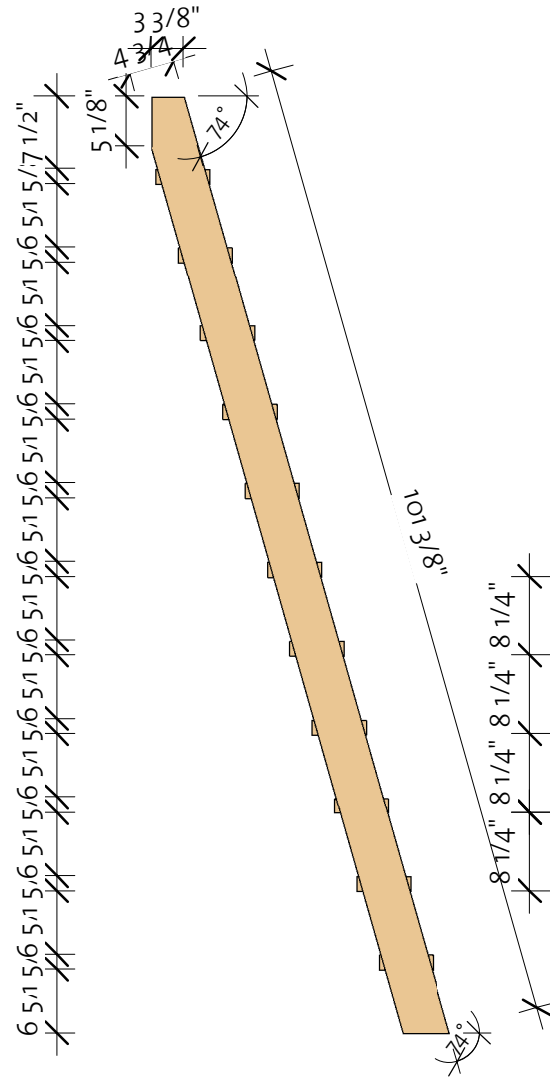
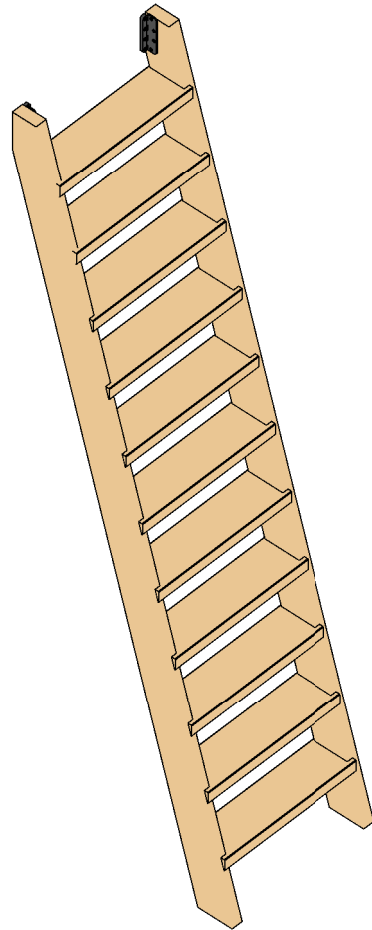

Colwood Bunkie 40 (131 7/8"x117 3/4")

Stairs



Stairs				
Mark	Profile	Profile	Count	Cut Length
ST1L	Stair 40X120		1	$102\frac{3}{8}$ "
ST1R	Stair 40X120		1	$102\frac{3}{8}$ "
ST2	Stair 143X40		11	$20\frac{1}{2}$ "

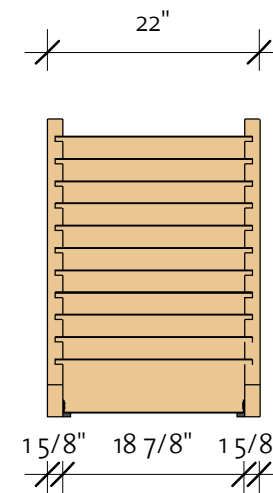

Colwood Bunkie 40 (131 7/8"x117 3/4")

Fence

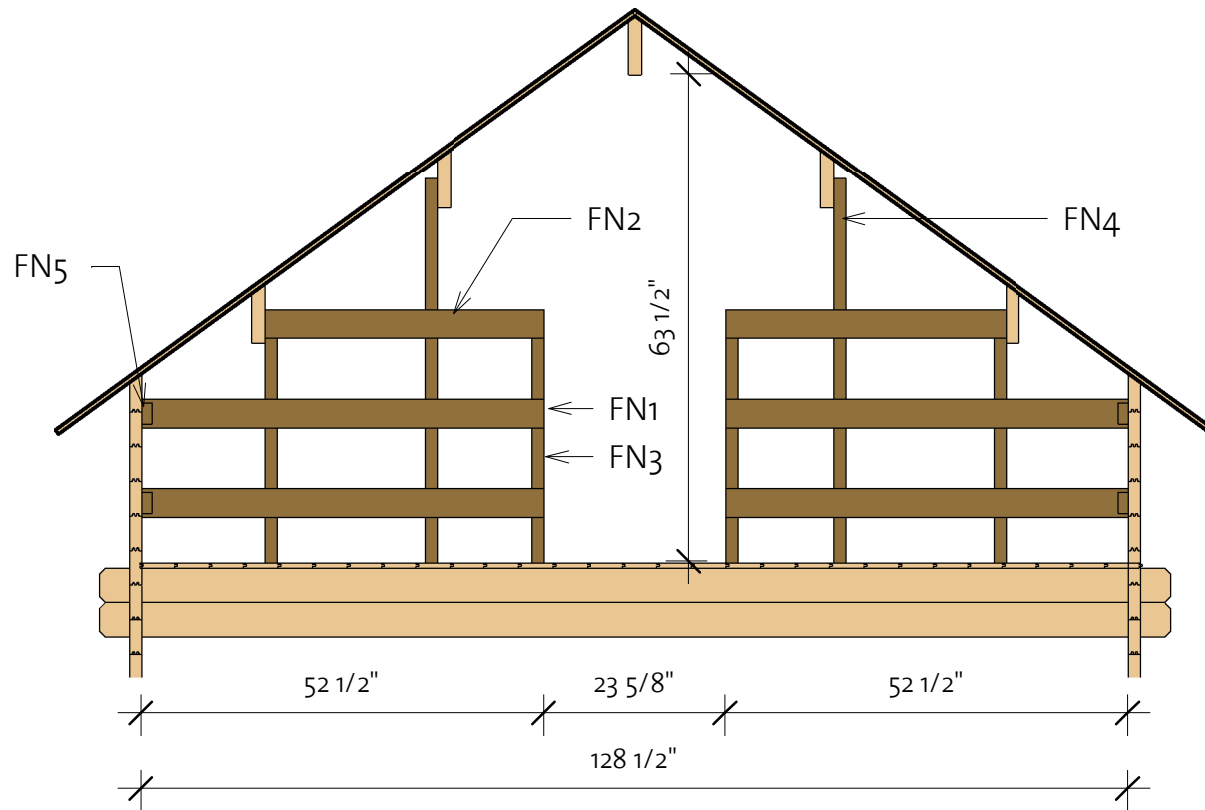

Fence schedule				
Mark	Type	Profile	Length	Count
FN1	Fence 18x95		52 5/8"	4
FN2	Fence 18x95		36 3/8"	2
FN3	Fence 40x70		42 1/2"	4
FN4	Fence 40x70		59 1/2"	2
FN5	Fence 70x40		3 1/2"	4

Colwood Bunkie 40 (131 7/8"x117 3/4")

Extras



Door Schedule				
Model	Type	Width	Height	Count
CD4R	Classic door 4 right	33 1/8"	77"	1
DCB6	Door Crossbar 6	--	--	0"





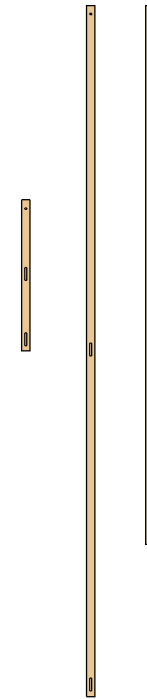

Type	Count
------	-------

Windboard 18x40x700	2
Windboard 18x40x2500	2
Windboard 18x40x3200	2

Type	Count
------	-------

Romb	2
------	---



Hitblock	300-400 mm		
Ladder fittings			2
Bolts	M8 x 70		16
Nails	1,4 x 40		50
Screws	6,0 x 140		65
Screws	5,0 x 70		70
Screws	4,0 x 40		885

Window Schedule				
Mark	Type	Width	Height	Count
CW1R	Classic window 1 right	30 1/8"	39"	2
CW12R	Classic window 12, full glass righth	21 1/4"	21 1/4"	2
CW21R	Classic window 21 right	20 1/4"	74 3/8"	2
WCB6	Windows Crossbar 6 optional	--	--	2
WCB8	Windows Crossbar8 optional			2

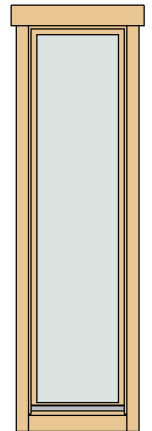
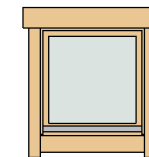
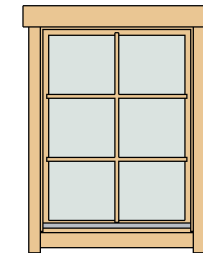



Colwood Bunkie 40 (131 7/8"x117 3/4")

List of all items 1



Impregnated foundation beams

Mark	Type	Profile	Count	Length
IFB1	IFB 70x40		2	117 1/4"
IFB2	IFB 70x40		7	125 3/4"

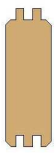

Roof

Mark	Type	Profile	Count	Length
RFR	Ridge 45x195		1	157"
RFB	Beam 45x195		4	157"
RB	17x114		72	93 1/4"

Second floor schedule





Mark	Type	Profile	Length	Count
CL1	Log 40x114		139 1/2"	2
CL2	Log 40x114		139 1/2"	2
CL3	Log 40x114		128 3/8"	1

Floor Schedule

Mark	Type	Profile	Count	Length
FB1	FB 17x114		30	114 1/8"
FB2	FB 17x114		30	64 3/4"



BB1	BB 20x40		3	131 7/8"
BB2	BB 20x40		3	118 1/8"

Fascia Schedule

Mark	Type	Profile	Count	Length
EE	Eave Edging 18x95		4	94 3/4"
RF	Roof Fascia 18x120		4	94 3/4"
RR1	Roof reinforce ment 18x95		2	157"
RR2	Roof reinforce ment 38x38		2	157"

Colwood Bunkie 40 (131 7/8"x117 3/4")



List of all items 2

Stairs				
Mark	Profile	Profile	Count	Cut Length
ST1L	Stair 40x120		1	102 3/8"
ST1R	Stair 40x120		1	102 3/8"
ST2	Stair 143x40		11	20 1/2"

Wall A			
Mark	Profile	Count	Cut Length
ALG-1	40x114	18	47 5/8"
ALG-2	40x114	9	125 1/2"
ALG-3	40x114	1	133 3/8"
ALG-4	40x114	1	141 1/4"
ALG-5	40x114	1	149 1/8"
ALG-6	40x114	1	157"
ALG-7	40x114	1	157"
ALG-8	40x114	4	157"
ATL-1	40x123	1	157"

Wall B			
Mark	Profile	Count	Cut Length

BLG-1	40x114	18	47 5/8"
BLG-2	40x114	9	125 1/2"
BLG-3	40x114	1	133 3/8"
BLG-4	40x114	1	141 1/4"
BLG-5	40x114	1	149 1/8"
BLG-6	40x114	1	157"
BLG-7	40x114	1	157"
BLG-8	40x114	4	157"
BTL-1	40x123	1	157"

Fence schedule				
Mark	Type	Profile	Length	Count
FN1	Fence 18x95		52 5/8"	4
FN2	Fence 18x95		36 3/8"	2
FN3	Fence 40x70		42 1/2"	4
FN4	Fence 40x70		59 1/2"	2
FN5	Fence 70x40		3 1/2"	4

Colwood Bunkie 40 (131 7/8"x117 3/4")

List of all items 3

Wall 1			
Mark	Profile	Count	Cut Length

1LG-1 *	40X114	1	12 3/8"
1LG-2 *	40X114	1	24 3/4"
1LG-3 *	40X114	1	37 1/8"
1LG-4 *	40X114	1	48 1/8"
1LG-5 *	40X114	1	61 7/8"
1LG-6 *	40X114	2	26 3/8"
1LG-7 *	40X114	2	32 5/8"
1LG-8 *	40X114	2	37 1/2"
1LG-9 *	40X114	2	45"
1LG-10*	40X114	2	51 1/8"
1LG-11 *	40X114	1	136 1/8"
1LG-12 *	40X114	1	139 1/2"
1LG-13	40X114	5	139 1/2"

Wall 2			
Mark	Profile	Count	Cut Length

2BL-1	40X57	2	53"
2LG-1	40X114	34	13 1/2"
2LG-2	40X114	34	19"
2LG-3	40X114	4	139 1/2"
2LG-4	40X114	1	139 1/2"

Wall 3			
Mark	Profile	Count	Cut Length



3LG-1	40X114	1	139 1/2"
3LG-2	40X114	1	139 1/2"

Wall 4			
Mark	Profile	Count	Cut Length

4BL-1	40X57	1	139 1/2"
4LG-1 *	40X114	1	12 3/8"
4LG-2 *	40X114	1	24 3/4"
4LG-3 *	40X114	1	37 1/8"
4LG-4 *	40X114	1	48 1/8"
4LG-5 *	40X114	1	61 7/8"
4LG-6 *	40X114	2	26 3/8"
4LG-7 *	40X114	2	32 5/8"
4LG-8 *	40X114	2	37 1/2"
4LG-9 *	40X114	2	45"
4LG-10*	40X114	2	51 1/8"
4LG-11 *	40X114	1	136 1/8"
4LG-12*	40X114	1	139 1/2"
4LG-13	40X114	26	139 1/2"

* Gable - delivered premounted

Log profiles	
Profile	Profile

40X57	
40X114	
40X114	

Log profiles	
Profile	Profile

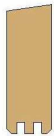
40X123	
40X123	