

# Denver 1 1 1/8" (110 1/4" x 70 7/8")

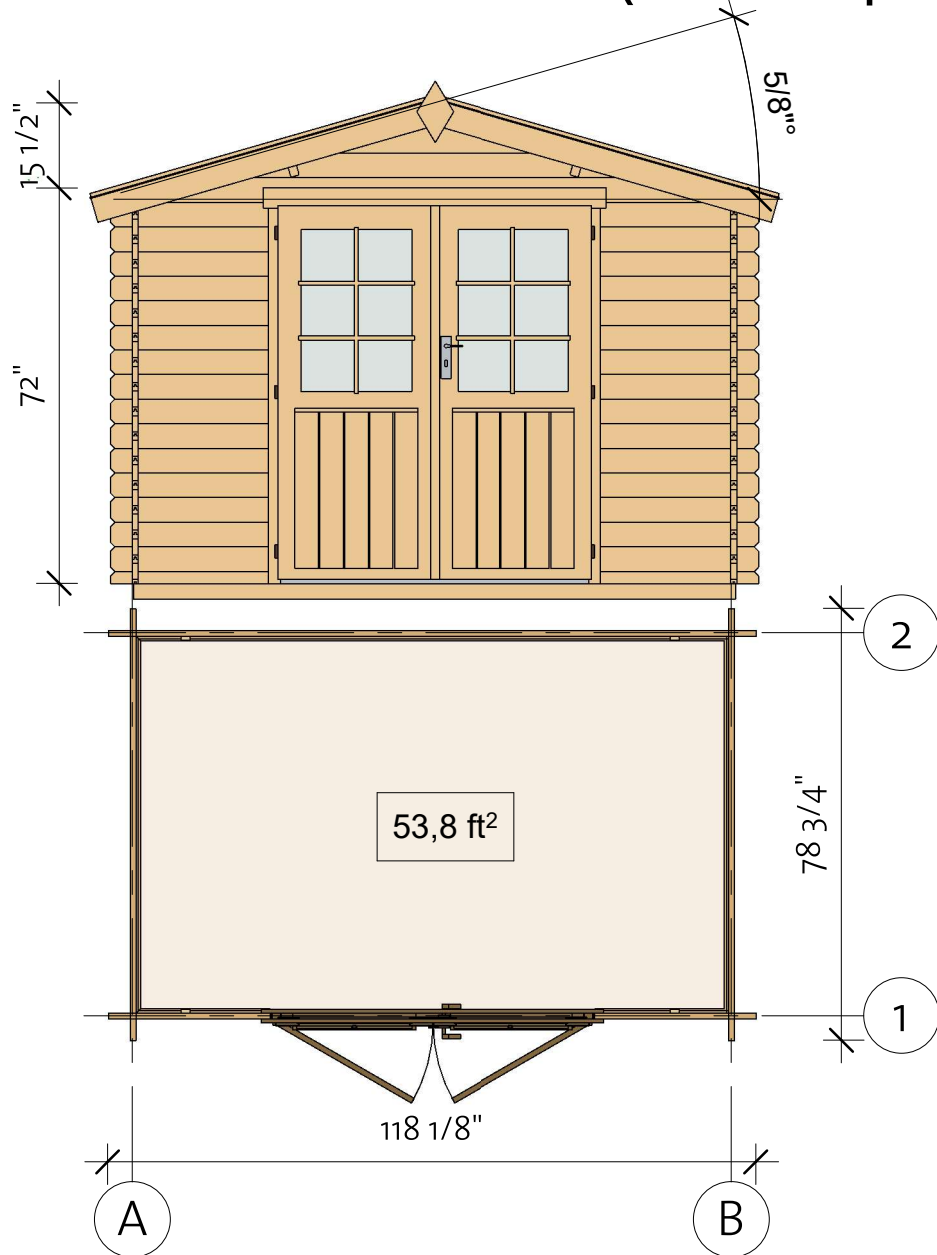

190417

# Denver 1 1/8" (110 1/4"x70 7/8")

Foundation

Impregnated foundation beams				
Mark	Type	Profile	Count	Length

IFB	IFB 40x70		5	109 13/16"
-----	--------------	---	---	---------------

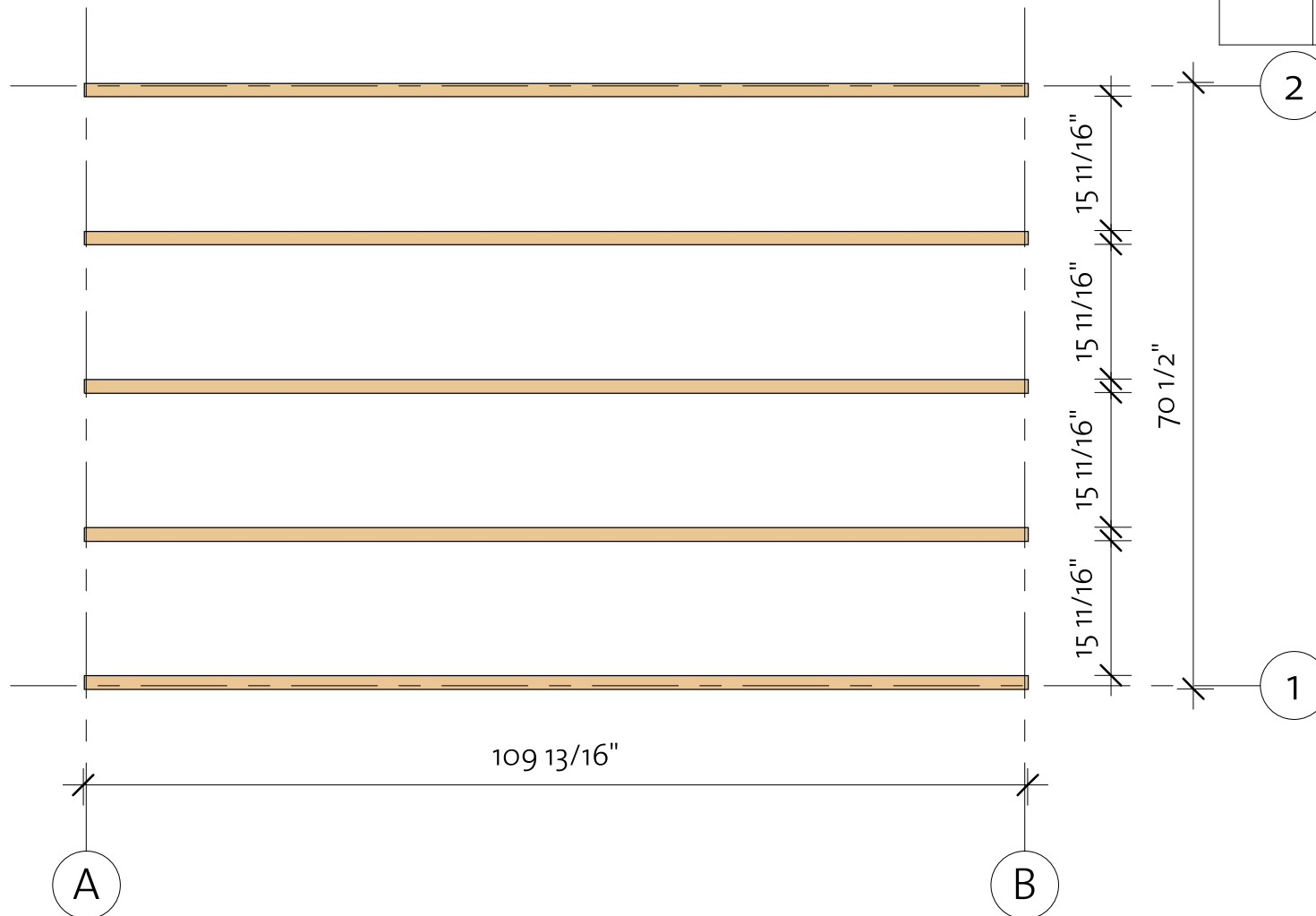



# Denver 1 1/8" (110 1/4"x70 7/8")

Floor Plan

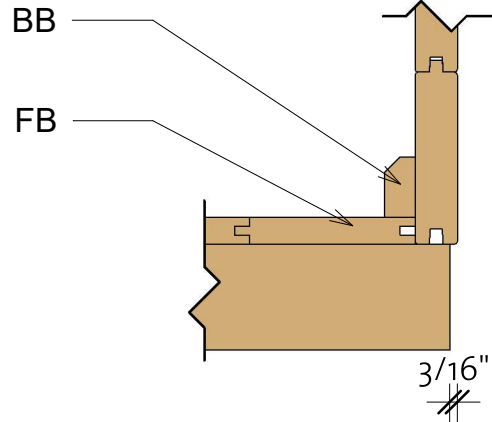
① Baseboard



Floor Schedule				
Mark	Type	Profile	Count	Length

FB	FB 18x110		26	68 1/2"
BB1	BB 20x40		2	110 1/4"
BB2	BB 20x40		2	70 7/8"

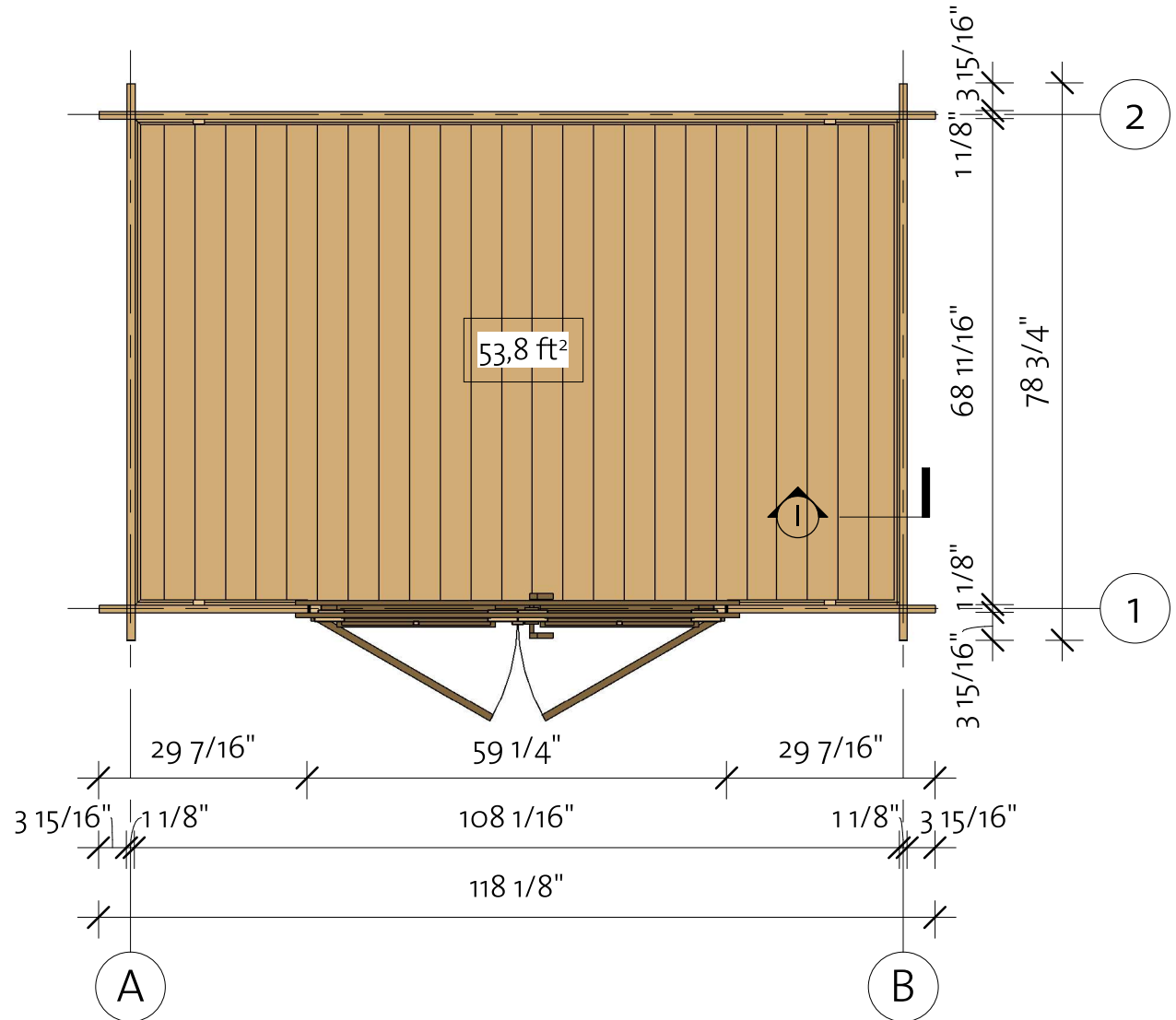

# Denver 1 1 1/8" (110 1/4"x70 7/8")

Wall 1

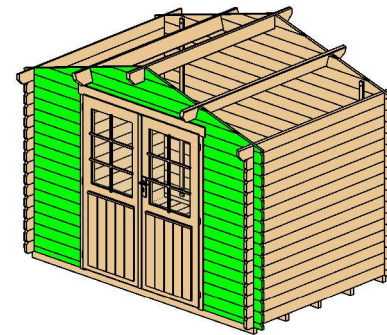

Wall 1			
Mark	Profile	Count	Cut Length

1BL 1	28x57	2	29 1/2"
1LG 1	28x114	30	29 1/2"
1LG 2*	28x114	1	31 1/4"
1LG 3*	28x114	1	62 1/2"
1LG 4*	28x114	1	93 13/16"
1LG 5*	28x114	1	118 1/8"

\* Gable - delivered premounted

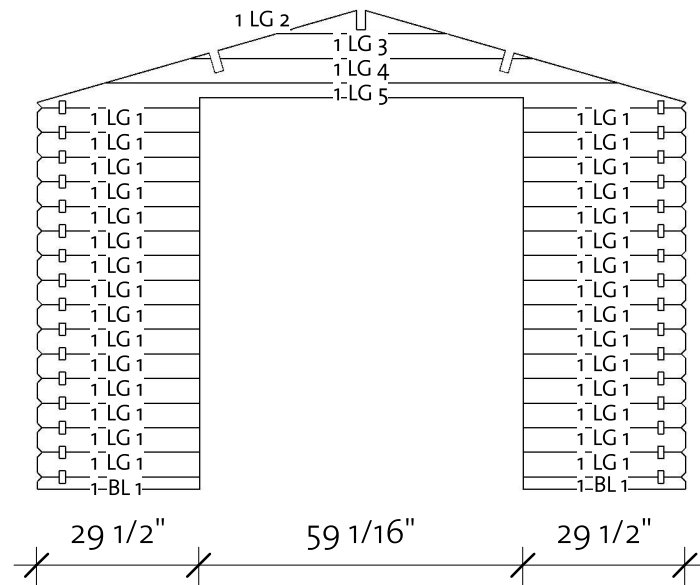

Log Profile Wall 1	
Profile	Profile

28x57	
28x114	

# Denver 1 1 1/8" (110 1/4"x70 7/8")

Wall 2

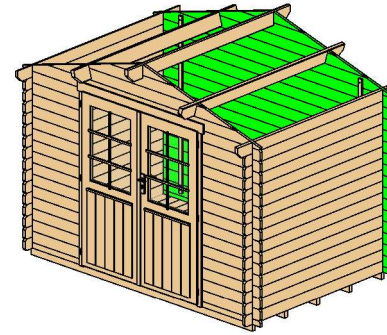

Wall 2			
Mark	Profile	Count	Cut Length

2BL 1	28x57	1	118 1/8"
2LG 1*	28x114	1	31 1/4"
2LG 2*	28x114	1	62 1/2"
2LG 3*	28x114	1	93 13/16"
2LG 4*	28x114	1	118 1/8"
2LG 5	28x114	15	118 1/8"

\* Gable - delivered premounted

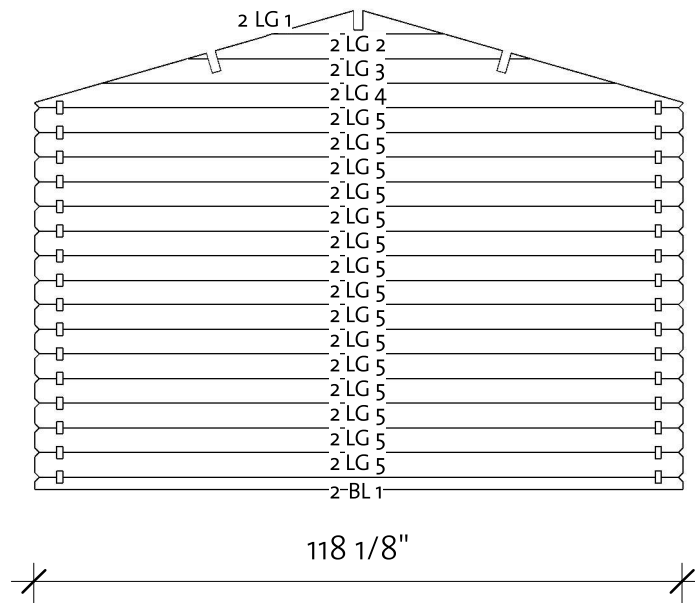

Log Profile Wall 2	
Profile	Profile

28x57	
28x114	

# Denver 1 1/8" (110 1/4"x70 7/8")

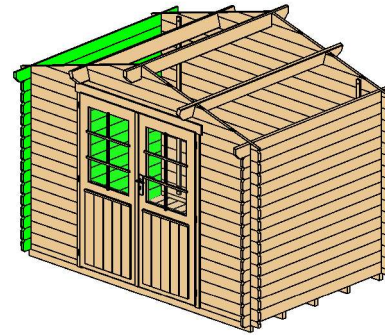

Wall A

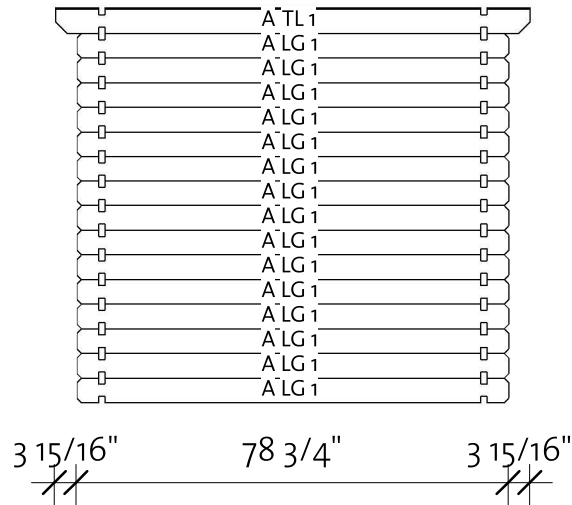

Wall A			
Mark	Profile	Count	Cut Length
ALG 1	28x114	15	78 3/4"
ATL 1	28x119	1	86 5/8"



Log Profile Wall A	
Profile	Profile

28x114	
28x119	

# Denver 1 1/8" (110 1/4"x70 7/8")

Wall B

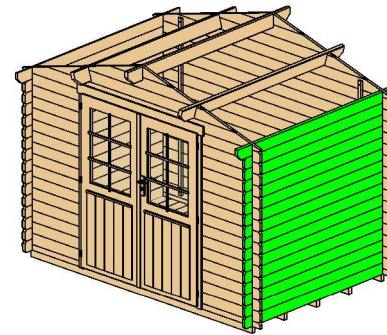

Wall B			
Mark	Profile	Count	Cut Length

BLG 1	28x114	15	78 3/4"
BTL 1	28x119	1	86 5/8"

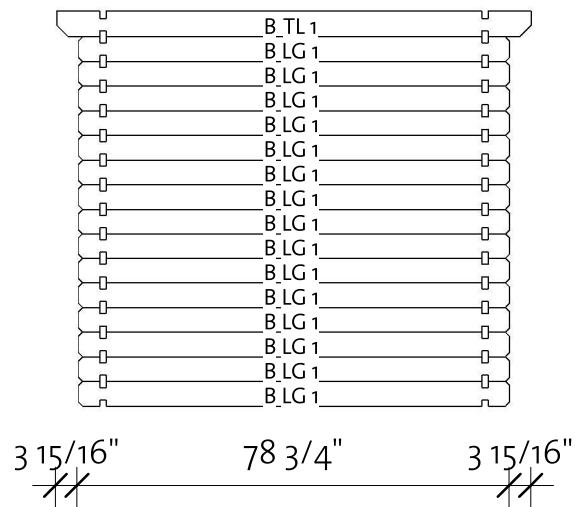





Log Profile Wall B	
Profile	Profile

28x114	
28x119	

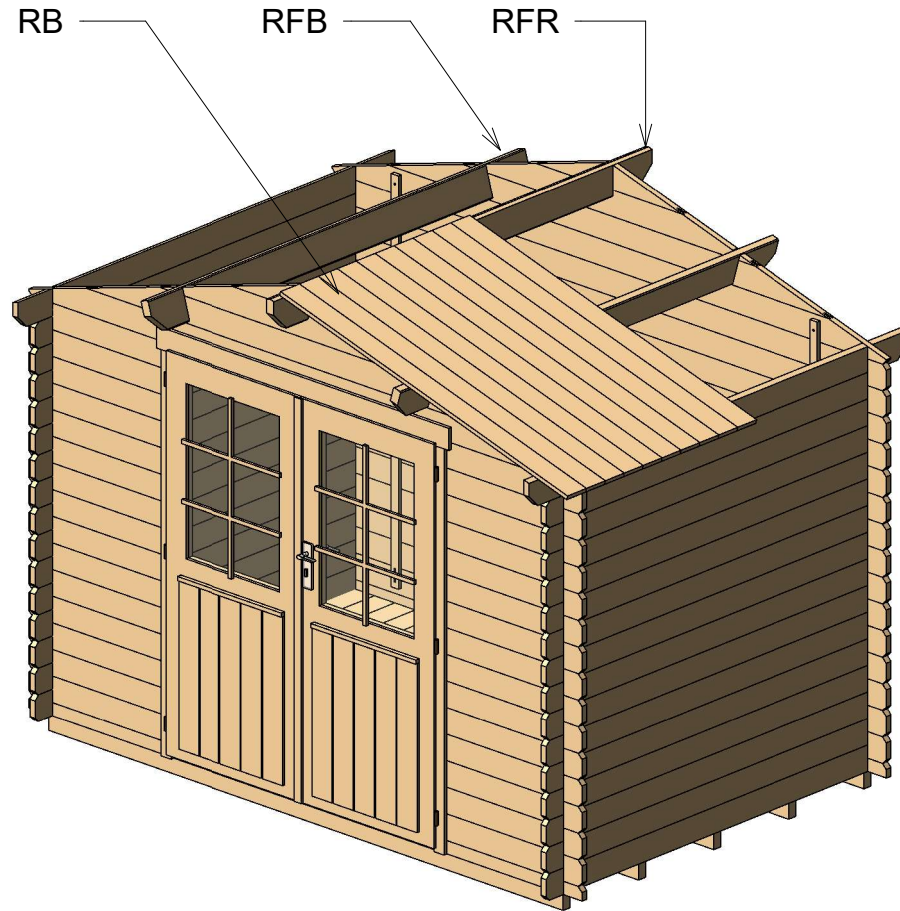
# Denver 1 1 1/8" (110 1/4"x70 7/8")

Roof 1



Roof				
Mark	Type	Profile	Count	Length
RFR	Ridge 40x143		1	86 5/8"
RFB	Beam 40x143		2	86 5/8"
RB	Roofboard 18x110		42	63 9/16"



# Denver 1 1/8" (110 1/4"x70 7/8")

Roof 2

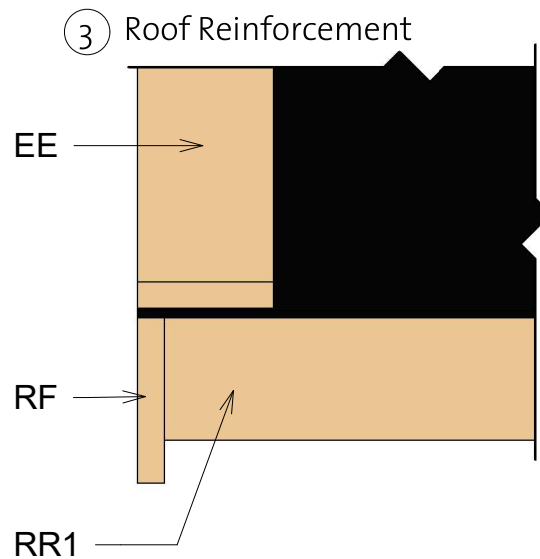
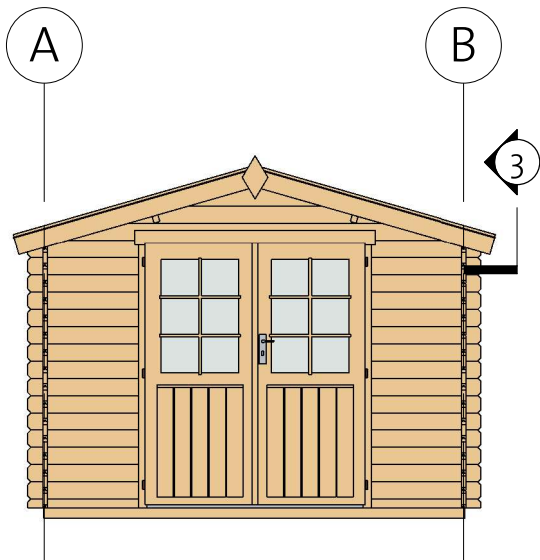
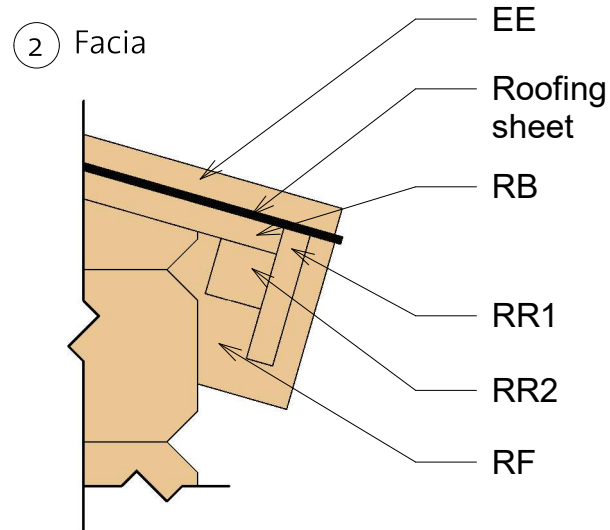
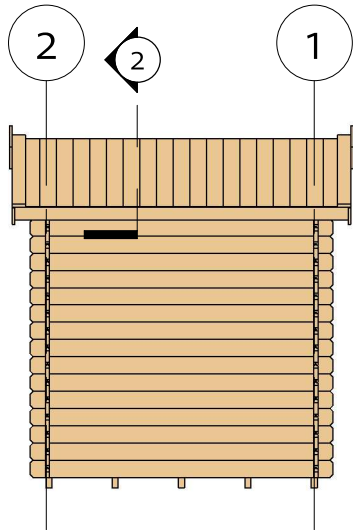

Fascia Schedule				
Mark	Type	Profile	Count	Length
EE	Eave Edging 18x90		4	65 3/16"
RF	Roof Fascia 18x115		4	65 3/16"
RR1	Roof reinforcement 18x90		2	86 5/8"
RR2	Roof reinforcement 38x38		2	86 5/8"

# Denver 1 1 1/8" (110 1/4" x 70 7/8")

Extras



Door Schedule				
Model	Type	Width	Height	Count
BDD2R	Basic double door 2 right	58 11/16"	69 7/8"	1
DCB6	Door crossbar 6	--	--	2

Type	Count	Lenght
Windboard 18x40	4	86 5/8"

Fasteners/Extras		
Name	Type	Count

Hitblock	11 13/16"-15 3/4"	
Screws	3/16" x 2 3/4"	10
Bolts	M5/16" x 2 3/8"	12
Screws	1/16" x 5 1/2"	25
Nails	1/4" x 1 9/16"	25
Screws	3/16" x 1 9/16"	75
Screws	3/16" x 2"	290



Family	Count
Romb	2

# Denver 1 1 1/8" (110 1/4"x70 7/8")

## List of all items 1



### Impregnated foundation beams

Mark	Type	Profile	Count	Length
------	------	---------	-------	--------

IFB	IFB 40x70		5	109 13/16"
-----	--------------	---	---	---------------



### Floor Schedule

Mark	Type	Profile	Count	Length
------	------	---------	-------	--------

FB	FB 18x110		26	68 1/2"
BB1	BB 20x40		2	110 1/4"
BB2	BB 20x40		2	70 7/8"





### Roof

Mark	Type	Profile	Count	Length
------	------	---------	-------	--------

RFR	Ridge 40x143		1	86 5/8"
RFB	Beam 40x143		2	86 5/8"
RB	Roofboard 18x110		42	63 9/16"

### Fascia Schedule

Mark	Type	Profile	Count	Length
------	------	---------	-------	--------

EE	Eave Edging 18x90		4	65 3/16"
RF	Roof Fascia 18x115		4	65 3/16"
RR1	Roof reinforcement 18x90		2	86 5/8"
RR2	Roof reinforcement 38x38		2	86 5/8"

# Denver 1 1 1/8" (110 1/4"x70 7/8")

## List of all items 2

Wall 1			
Mark	Profile	Count	Cut Length

1BL 1	28x57	2	29 1/2"
1LG 1	28x114	30	29 1/2"
1LG 2*	28x114	1	31 1/4"
1LG 3*	28x114	1	62 1/2"
1LG 4*	28x114	1	93 13/16"
1LG 5*	28x114	1	118 1/8"

Wall 2			
Mark	Profile	Count	Cut Length

2BL 1	28x57	1	118 1/8"
2LG 1*	28x114	1	31 1/4"
2LG 2*	28x114	1	62 1/2"
2LG 3*	28x114	1	93 13/16"
2LG 4*	28x114	1	118 1/8"
2LG 5	28x114	15	118 1/8"

\* Gable - delivered premounted



Wall A			
Mark	Profile	Count	Cut Length

ALG 1	28x114	15	78 3/4"
ATL 1	28x119	1	86 5/8"

Wall B			
Mark	Profile	Count	Cut Length

BLG 1	28x114	15	78 3/4"
BTL 1	28x119	1	86 5/8"

Log Profiles	
Profile	Profile

28x57	
28x114	
28x119	