

Denver 1 28 (280x180)

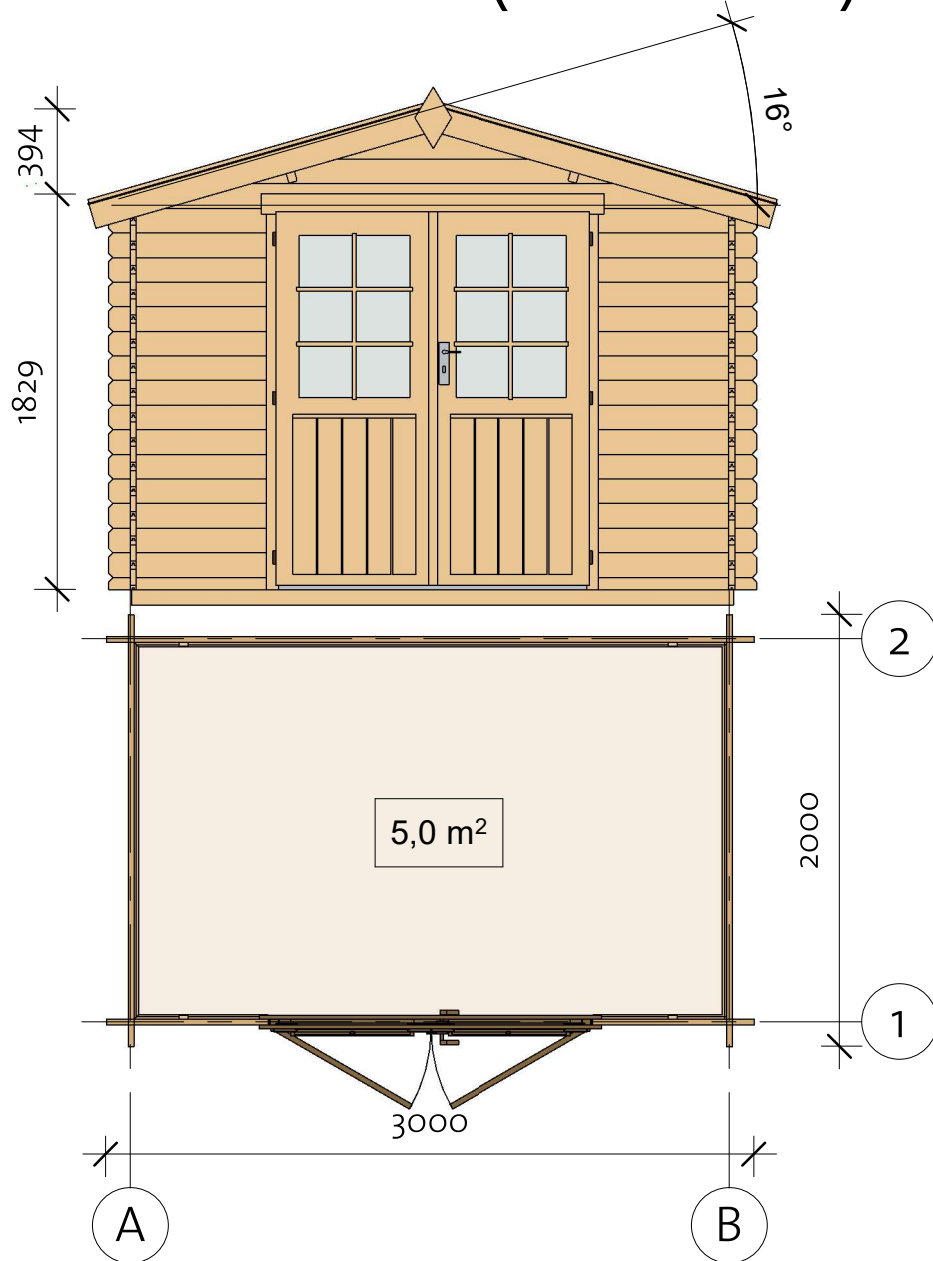

190417

Denver 1 28 (280x180)

Foundation

Impregnated foundation beams				
Mark	Type	Profile	Count	Length

IFB	IFB 40x70		5	2790
-----	--------------	---	---	------

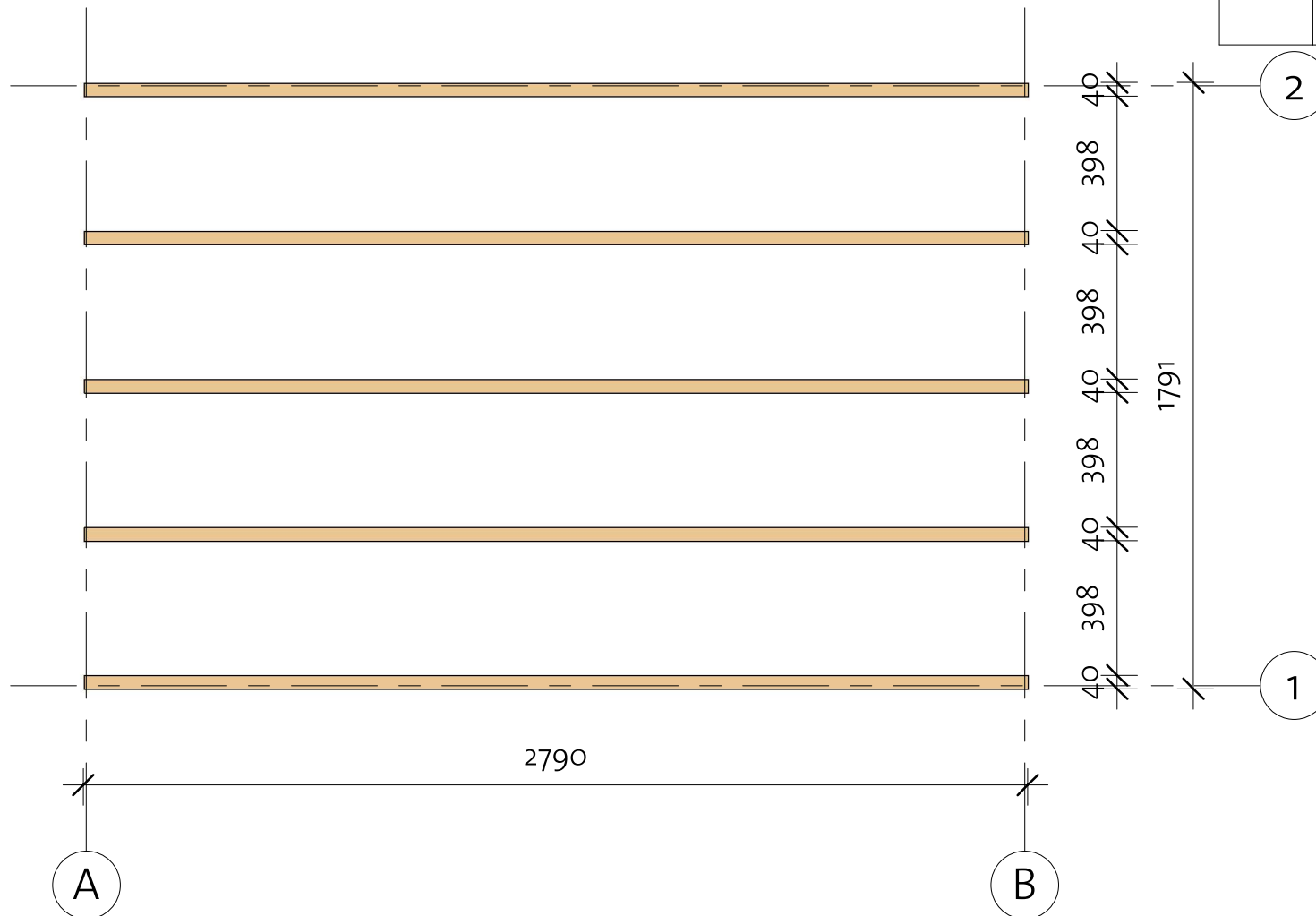

Denver 1 28 (280x180)

Floor Plan

① Baseboard

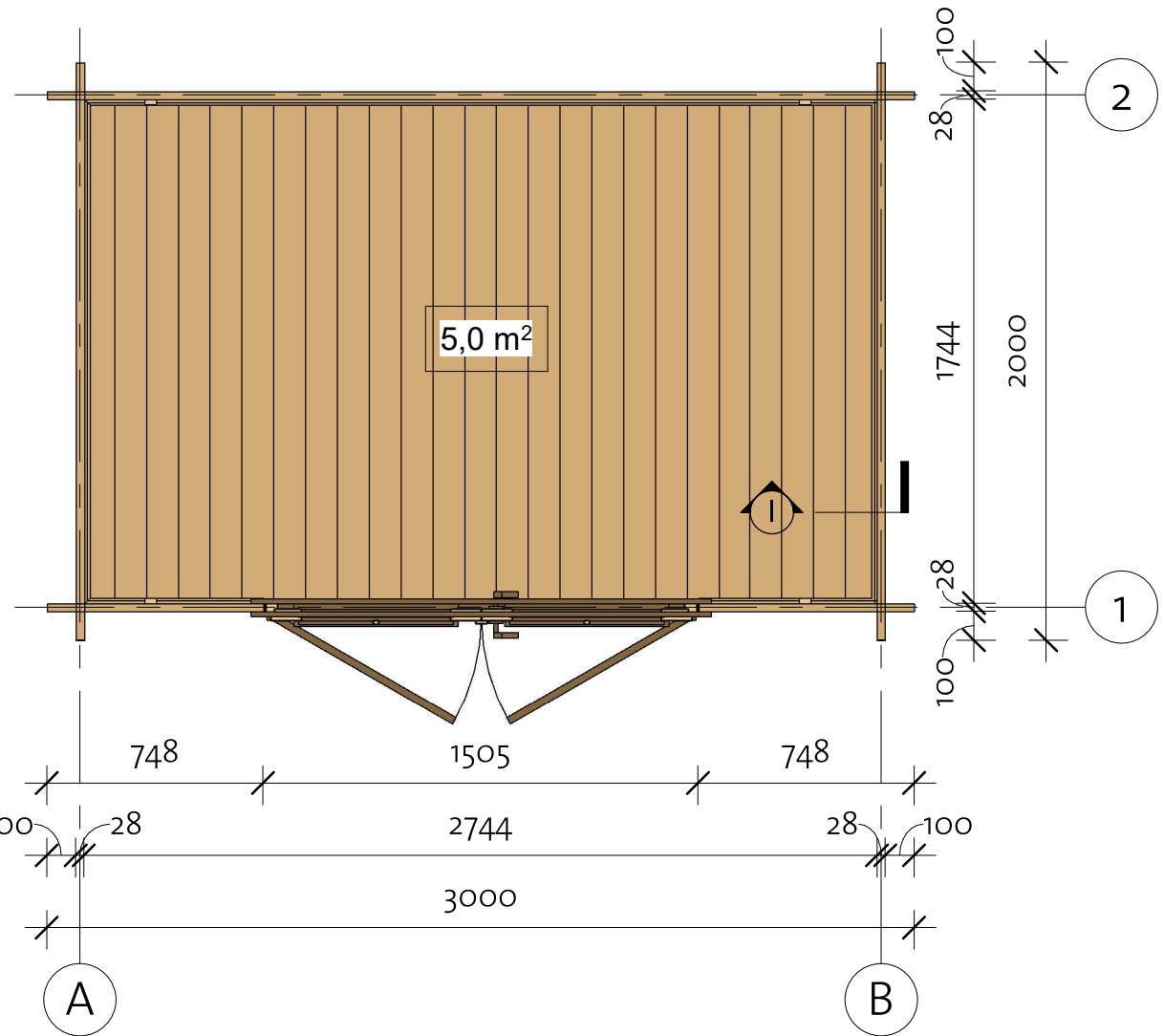
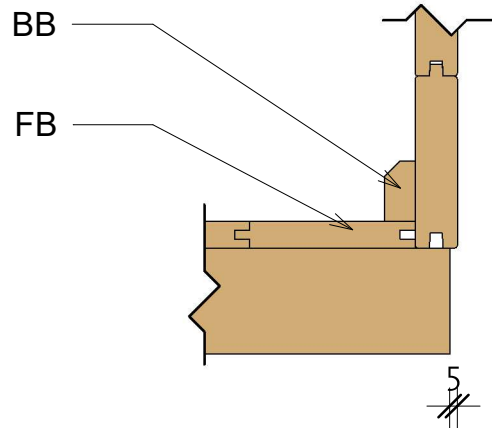

Floor Schedule

Mark	Type	Profile	Count	Length
------	------	---------	-------	--------

FB	FB 18x110		26	1740
BB1	BB 20x40		2	2800
BB2	BB 20x40		2	1800

Denver 1 28 (280x180)

Wall 1

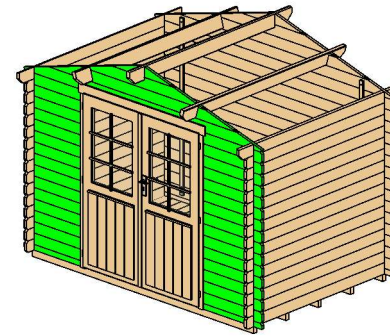

Wall 1			
Mark	Profile	Count	Cut Length

1BL 1	28x57	2	750
1LG 1	28x114	30	750
1LG 2*	28x114	1	794
1LG 3*	28x114	1	1588
1LG 4*	28x114	1	2382
1LG 5*	28x114	1	3000

* Gable - delivered premounted

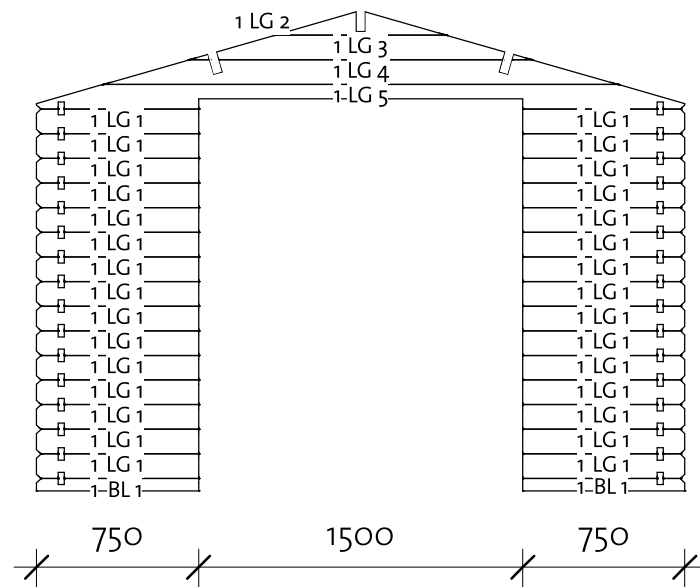

Log Profile Wall 1	
Profile	Profile

28x57	
28x114	

Denver 1 28 (280x180)

Wall 2

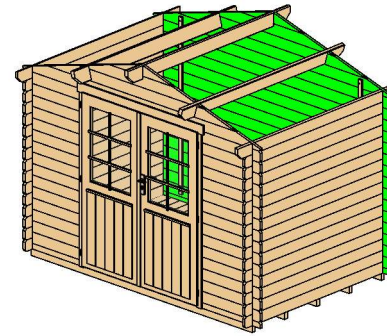

Wall 2			
Mark	Profile	Count	Cut Length

2BL 1	28x57	1	3000
2LG 1*	28x114	1	794
2LG 2*	28x114	1	1588
2LG 3*	28x114	1	2382
2LG 4*	28x114	1	3000
2LG 5	28x114	15	3000

* Gable - delivered premounted

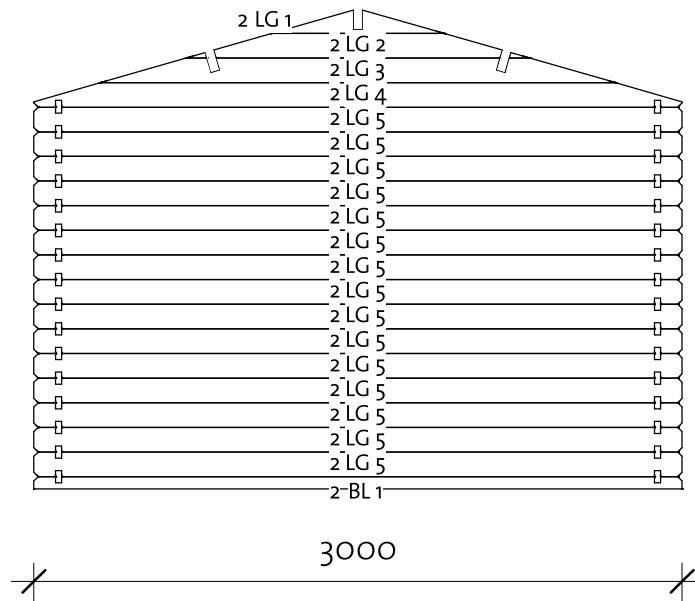

Log Profile Wall 2	
Profile	Profile

28x57	
28x114	

Denver 1 28 (280x180)

Wall A

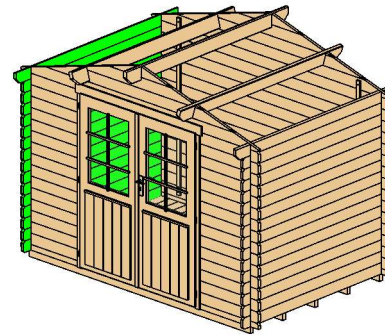

Wall A			
Mark	Profile	Count	Cut Length

ALG 1	28x114	15	2000
ATL 1	28x119	1	2200

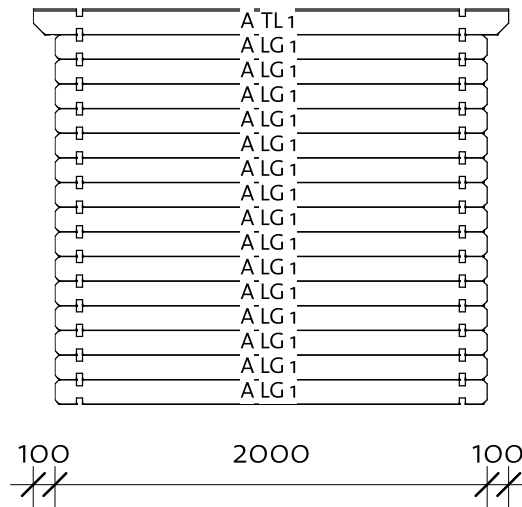

Log Profile Wall A	
Profile	Profile

28x114	
28x119	

Denver 1 28 (280x180)

Wall B

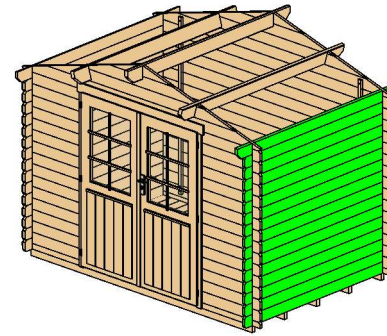

Wall B			
Mark	Profile	Count	Cut Length

BLG 1	28x114	15	2000
BTL 1	28x119	1	2200

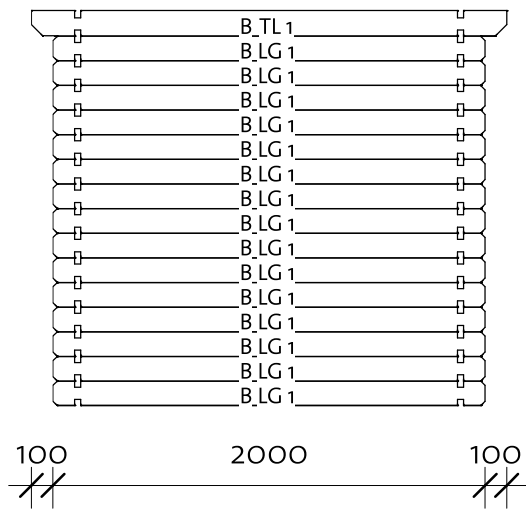





Log Profile Wall B	
Profile	Profile

28x114	
28x119	

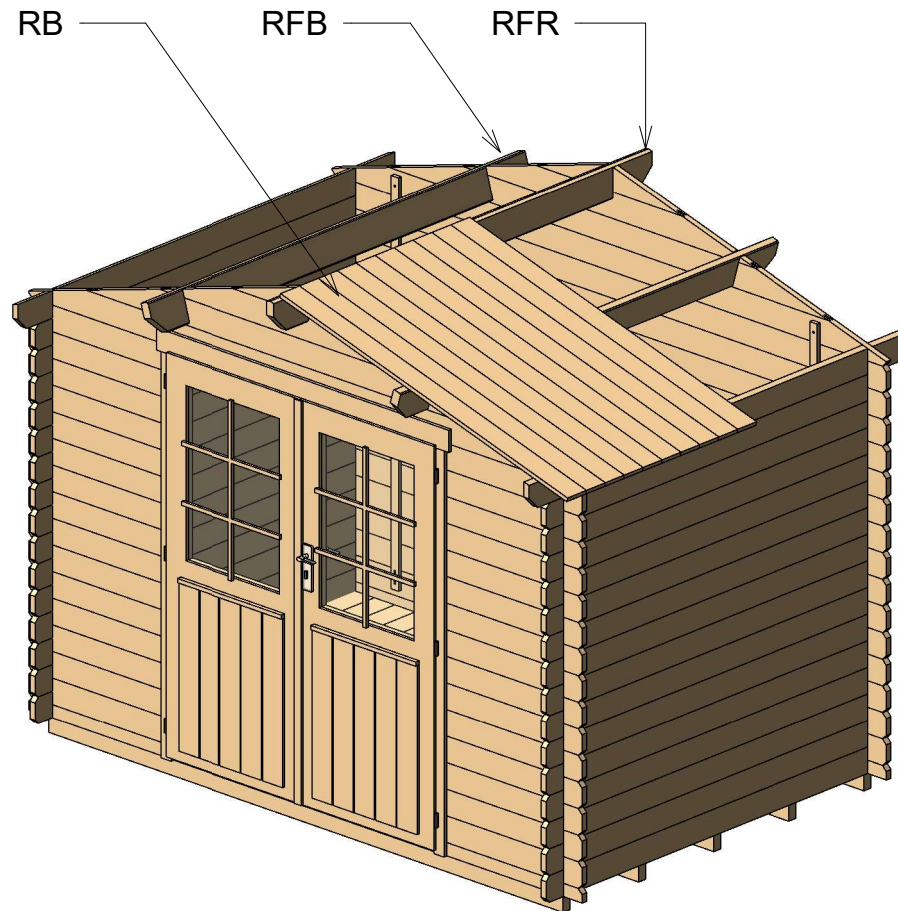
Denver 1 28 (280x180)

Roof 1



Roof				
Mark	Type	Profile	Count	Length
RFR	Ridge 40x143		1	2200
RFB	Beam 40x143		2	2200
RB	Roofboard 18x110		42	1615

Denver 1 28 (280x180)

Roof 2

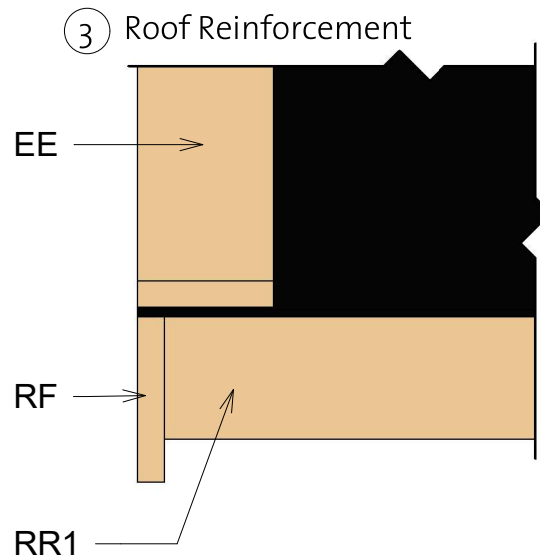
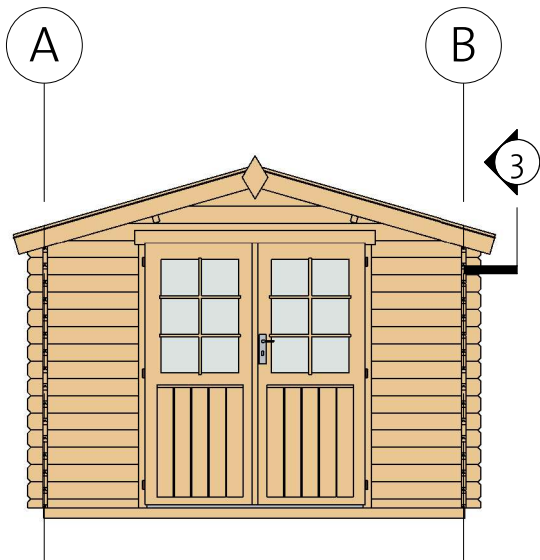
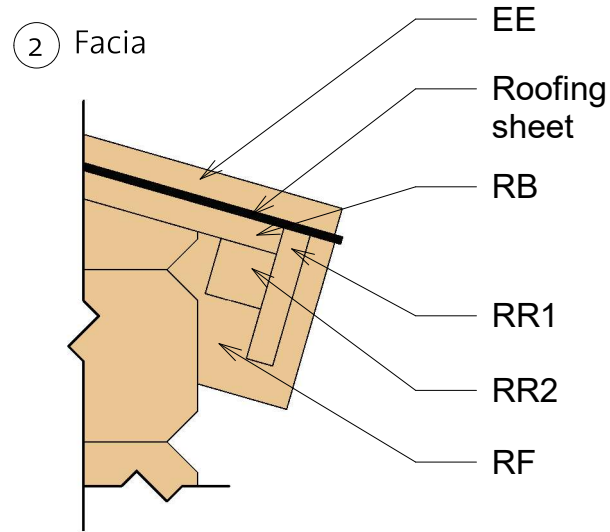
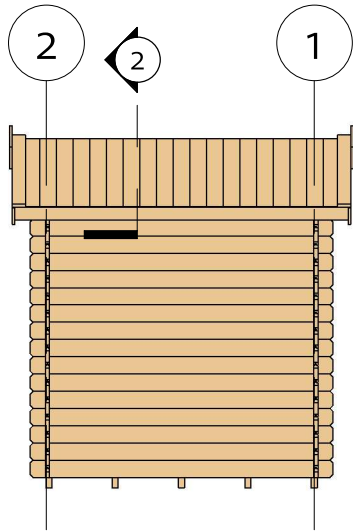

Fascia Schedule				
Mark	Type	Profile	Count	Length
EE	Eave Edging 18x90		4	1655
RF	Roof Fascia 18x115		4	1655
RR1	Roof reinforcement 18x90		2	2200
RR2	Roof reinforcement 38x38		2	2200

Denver 1 28 (280x180)

Extras

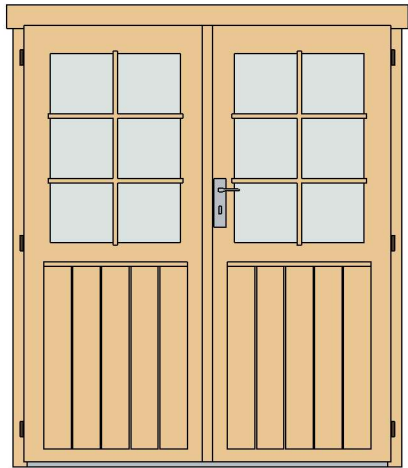

Door Schedule				
Model	Type	Width	Height	Count
BDD2R	Basic double door 2 right	1490	1775	1
DCB6	Door crossbar 6	--	--	2

Type	Count	Lenght
Windboard 18x40	4	2200

Fasteners/Extras		
Name	Type	Count



Family	Count
Romb	2

Hitblock	300-400 mm	
Screws	5,0 x 70	10
Bolts	M8 x 60	12
Nails	1,4 x 40	25
Screws	6,0 x 140	25
Screws	4,0 x 40	75
Screws	4,0 x 50	290

Denver 1 28 (280x180)

List of all items 1



Impregnated foundation beams

Mark	Type	Profile	Count	Length
------	------	---------	-------	--------

IFB	IFB 40x70		5	2790
-----	--------------	---	---	------



Floor Schedule

Mark	Type	Profile	Count	Length
------	------	---------	-------	--------

FB	FB 18x110		26	1740
BB1	BB 20x40		2	2800
BB2	BB 20x40		2	1800





Roof

Mark	Type	Profile	Count	Length
------	------	---------	-------	--------

RFR	Ridge 40x143		1	2200
RFB	Beam 40x143		2	2200
RB	Roofboard 18x110		42	1615

Fascia Schedule

Mark	Type	Profile	Count	Length
------	------	---------	-------	--------

EE	Eave Edging 18x90		4	1655
RF	Roof Fascia 18x115		4	1655
RR1	Roof reinforcement 18x90		2	2200
RR2	Roof reinforcement 38x38		2	2200

Denver 1 28 (280x180)

List of all items 2

Wall 1			
Mark	Profile	Count	Cut Length

1BL 1	28x57	2	750
1LG 1	28x114	30	750
1LG 2*	28x114	1	794
1LG 3*	28x114	1	1588
1LG 4*	28x114	1	2382
1LG 5*	28x114	1	3000

Wall 2			
Mark	Profile	Count	Cut Length

2BL 1	28x57	1	3000
2LG 1*	28x114	1	794
2LG 2*	28x114	1	1588
2LG 3*	28x114	1	2382
2LG 4*	28x114	1	3000
2LG 5	28x114	15	3000

* Gable - delivered premounted



Wall A			
Mark	Profile	Count	Cut Length

ALG 1	28x114	15	2000
ATL 1	28x119	1	2200

Wall B			
Mark	Profile	Count	Cut Length

BLG 1	28x114	15	2000
BTL 1	28x119	1	2200

Log Profiles	
Profile	Profile

28x57	
28x114	
28x119	