

Denver 4 1 1/8" (108 1/4"x141 3/4")

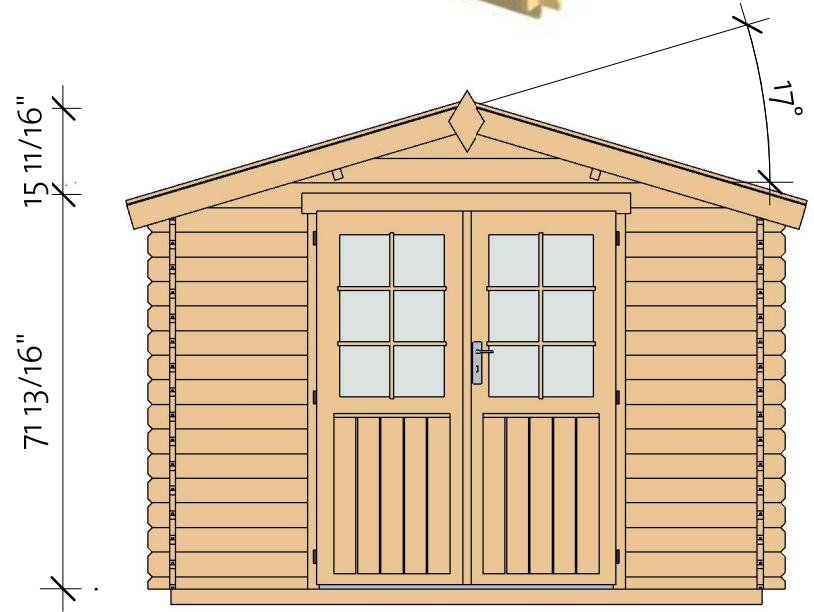

Denver 4 1 1/8" (108 1/4" x 141 3/4")

Foundation

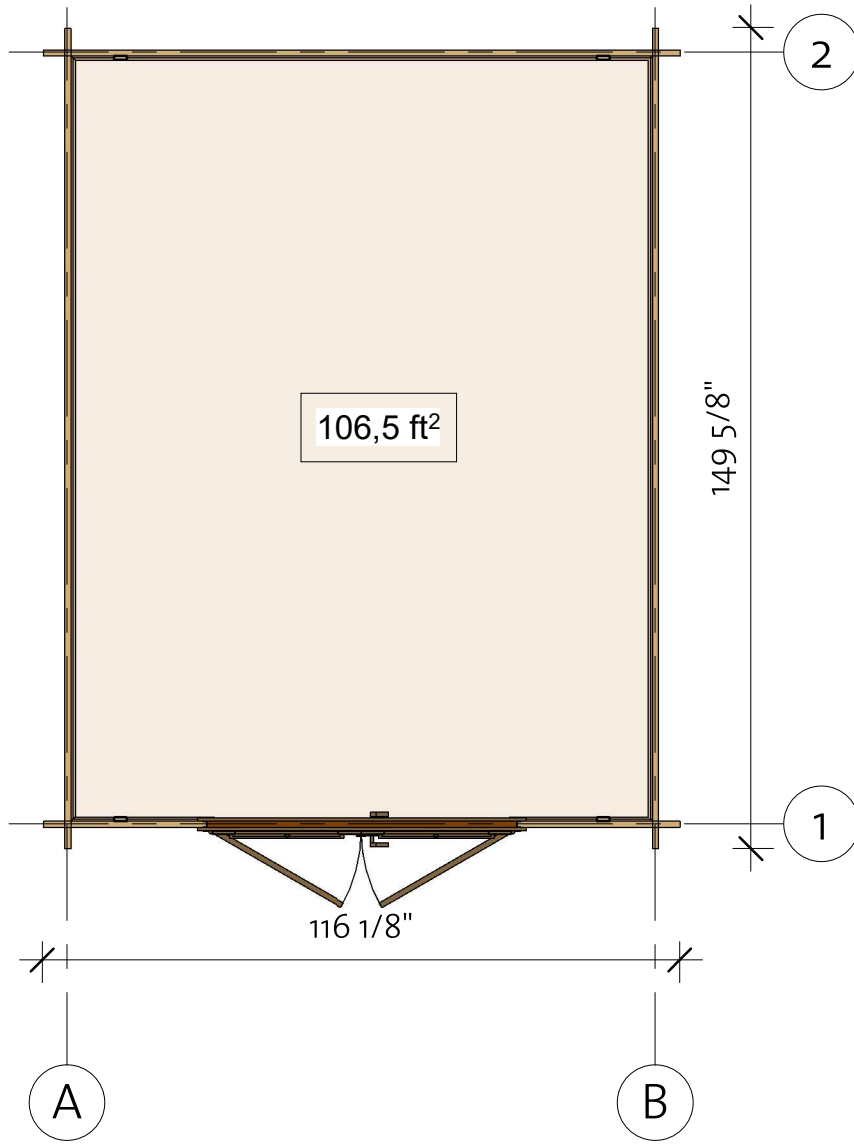
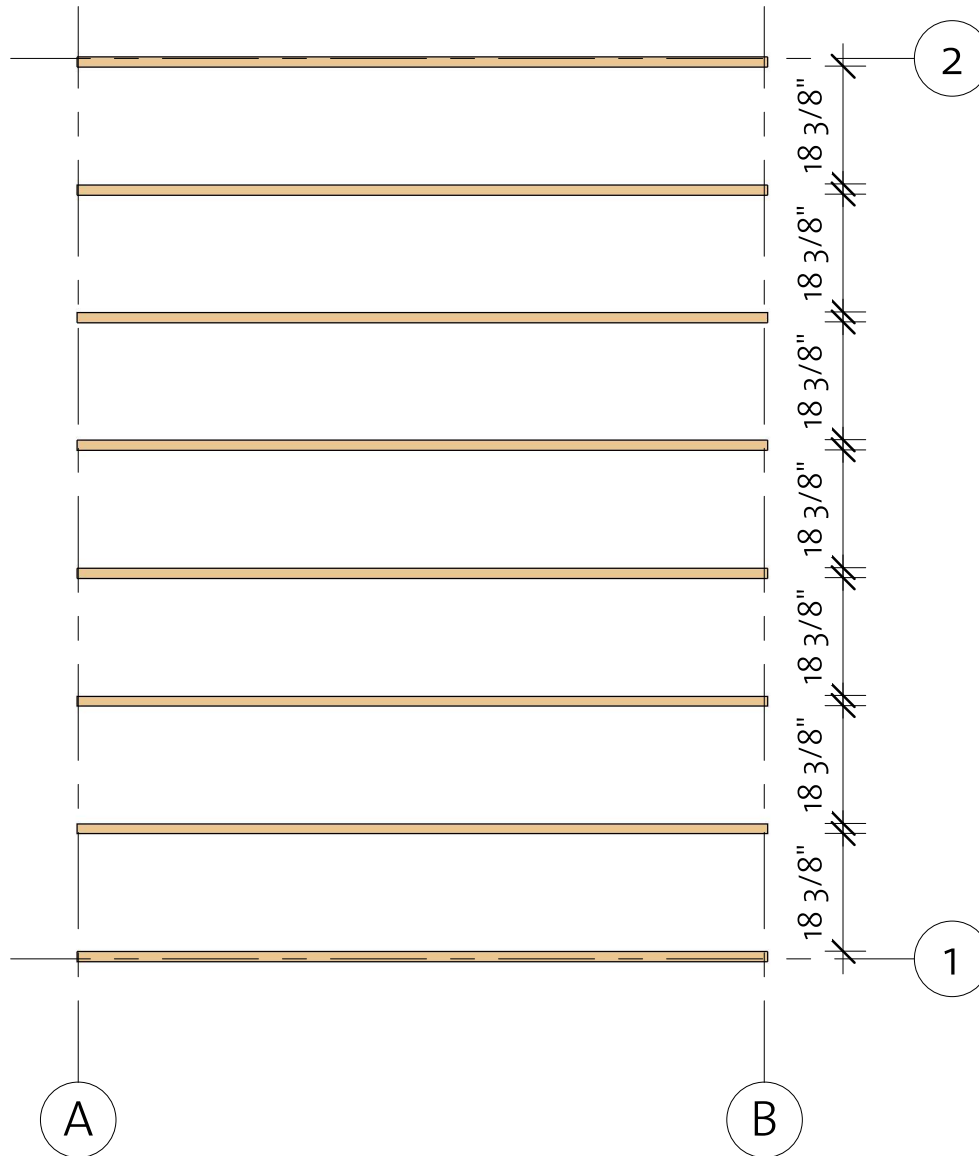

Impregnated foundation beams				
Mark	Type	Profile	Count	Length



IFB	IFB 40x70		8	107 7/8"
-----	--------------	---	---	-------------

Denver 4 1 1/8" (108 1/4" x 141 3/4")

Floor Plan

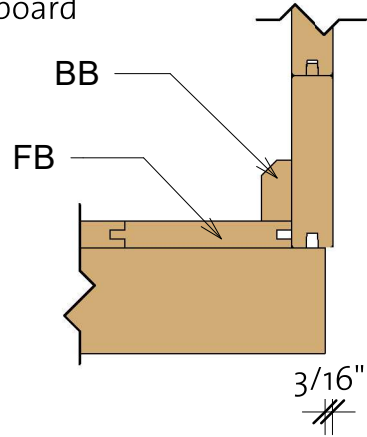
① Baseboard



Floor Schedule				
Mark	Type	Profile	Count	Length
FB	FB 18x110		26	139 3/8"
BB1	BB 40x20		2	141 3/4"
BB2	BB 40x20		2	108 1/4"

190418

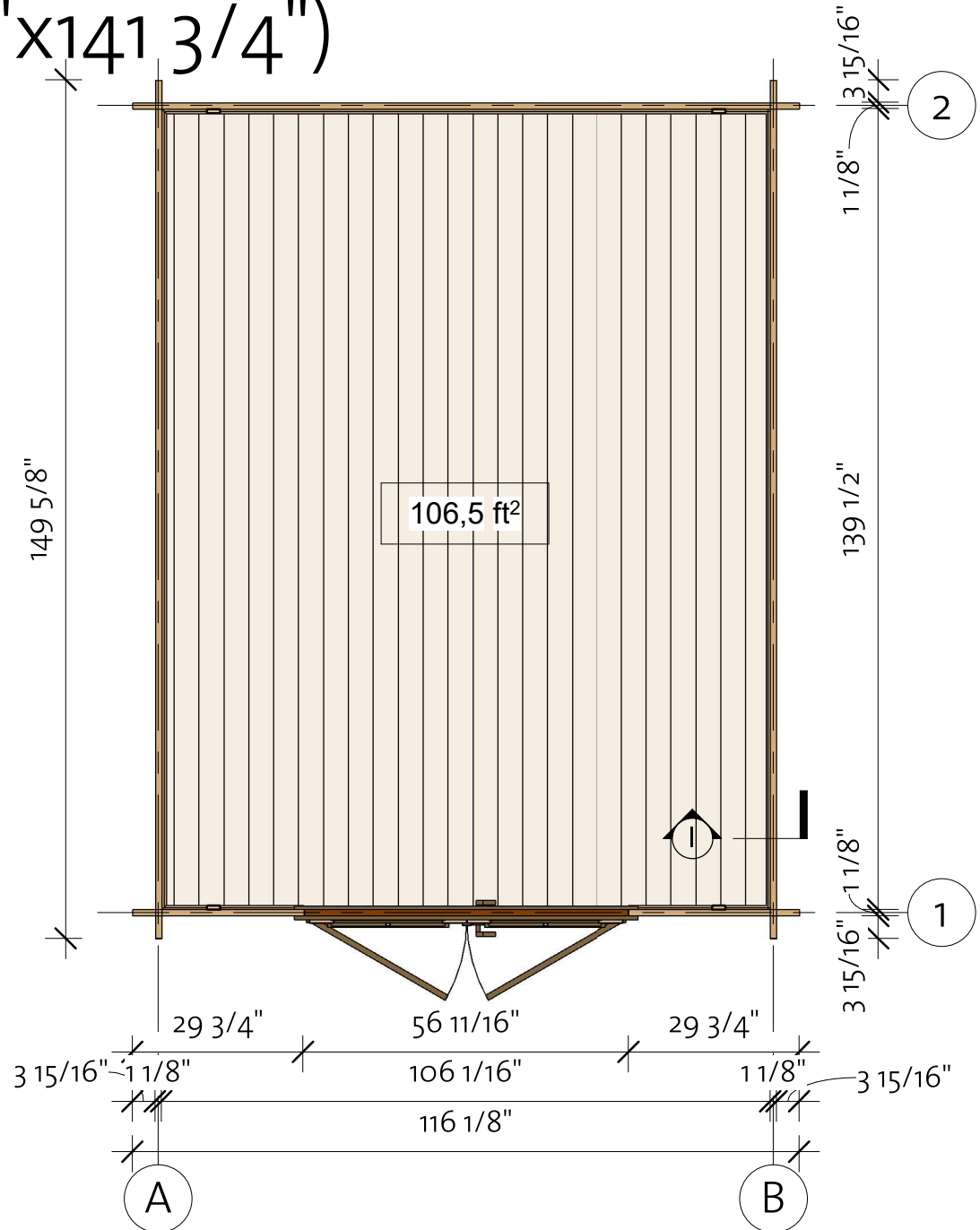

Denver 4 1 1/8" (108 1/4"x141 3/4")

Wall 1

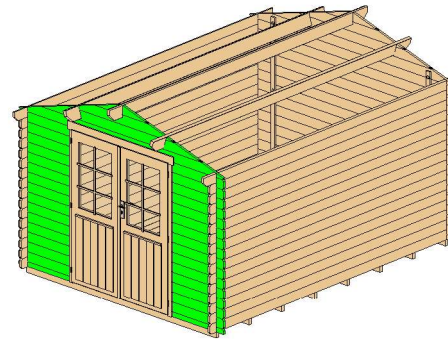

Wall 1			
Mark	Profile	Count	Cut Length

1BL 1	28x57	2	29 13/16"
1LG 1	28x114	30	29 13/16"
1LG 2*	28x114	1	30 7/16"
1LG 3*	28x114	1	60 3/4"
1LG 4*	28x114	1	91 1/16"
1LG 5*	28x114	1	116 1/8"

*Gable-delivered premounted

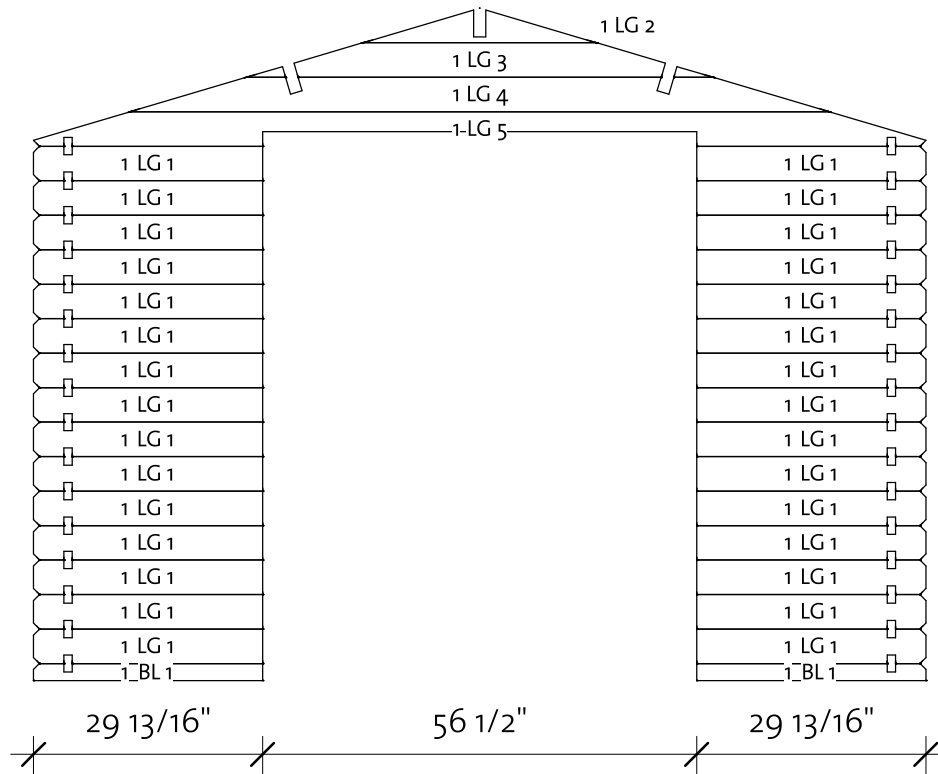

Log Profile Wall 1	
Profile	Profile

28x57	
28x114	

Denver 4 1 1/8" (108 1/4"x141 3/4")

Wall 2

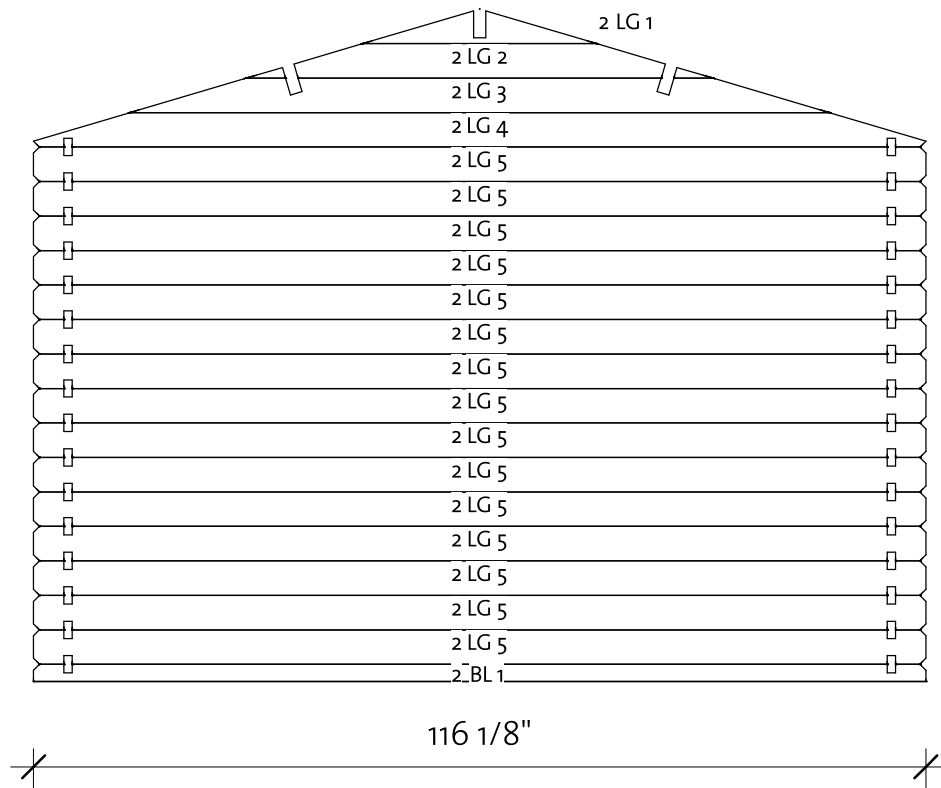
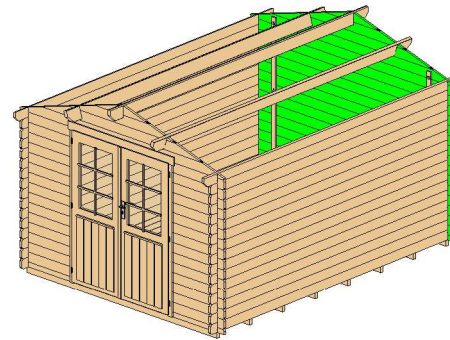

Wall 2			
Mark	Profile	Count	Cut Length

2BL 1	28x57	1	116 1/8"
2LG 1*	28x114	1	30 7/16"
2LG 2*	28x114	1	60 3/4"
2LG 3*	28x114	1	91 1/16"
2LG 4*	28x114	1	116 1/8"
2LG 5	28x114	15	116 1/8"

*Gable-delivered premounted

Log Profile Wall 2	
Profile	Profile

28x57	
28x114	

Denver 4 1 1/8" (108 1/4"x141 3/4")

Wall A

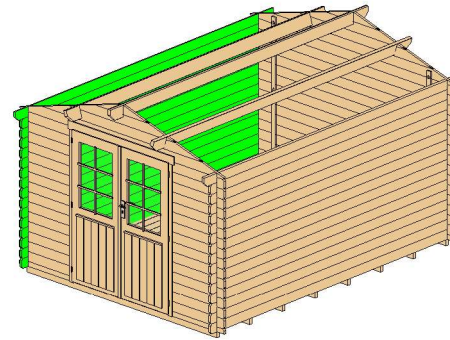

Wall A			
Mark	Profile	Count	Cut Length

ALG 1	28x114	15	149 5/8"
ATL 1	28x115	1	157 1/2"

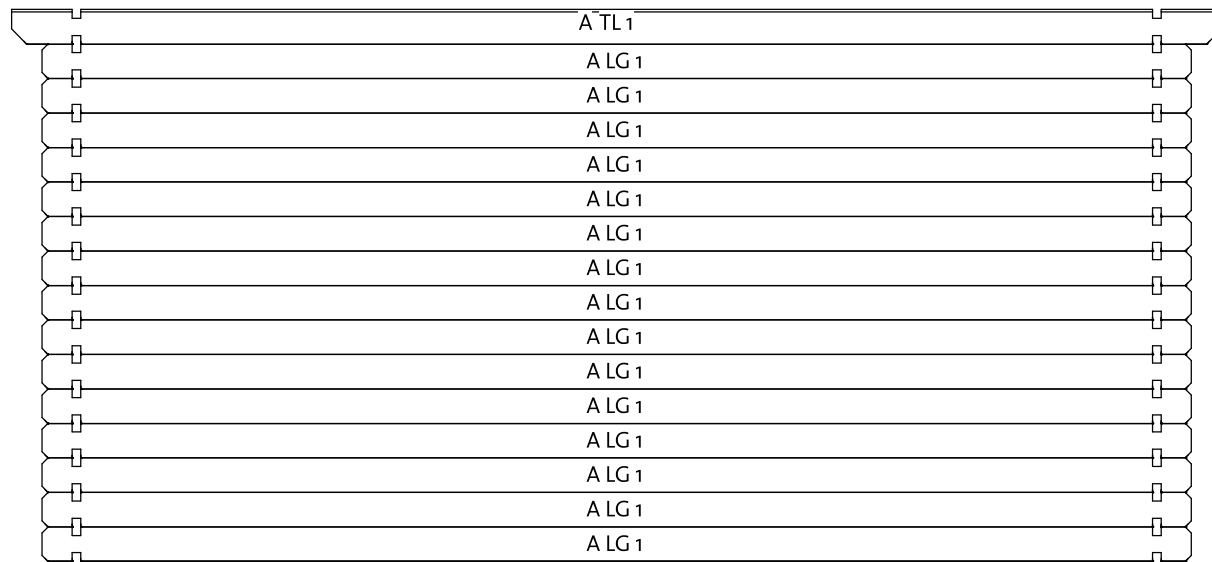

3 15/16"

149 5/8"

3 15/16"

Log Profile Wall A	
Profile	Profile

28x114	
28x115	

Denver 4 1 1/8" (108 1/4"x141 3/4")

Wall B

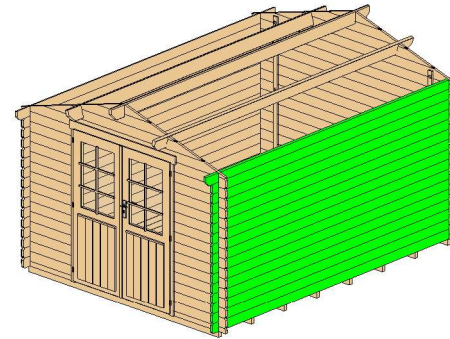

Wall B			
Mark	Profile	Count	Cut Length

BLG 1	28x114	15	149 5/8"
BTL 1	28x115	1	157 1/2"

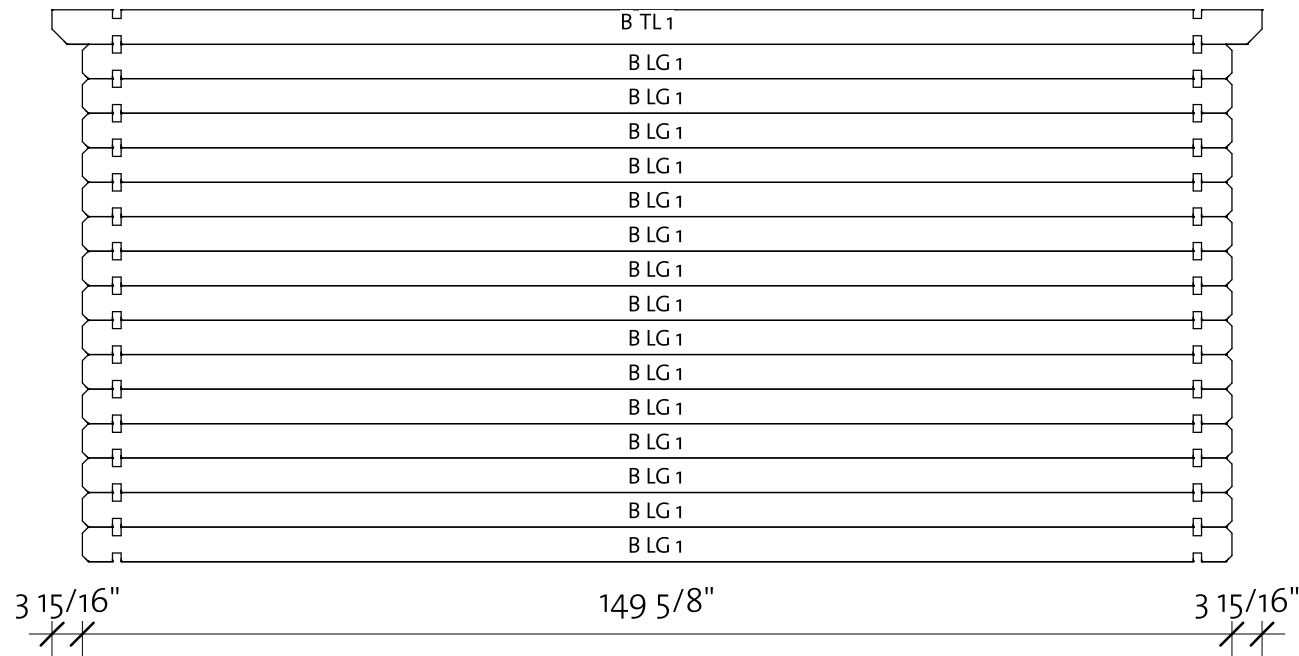





Log Profile Wall B	
Profile	Profile

28x114	
28x115	

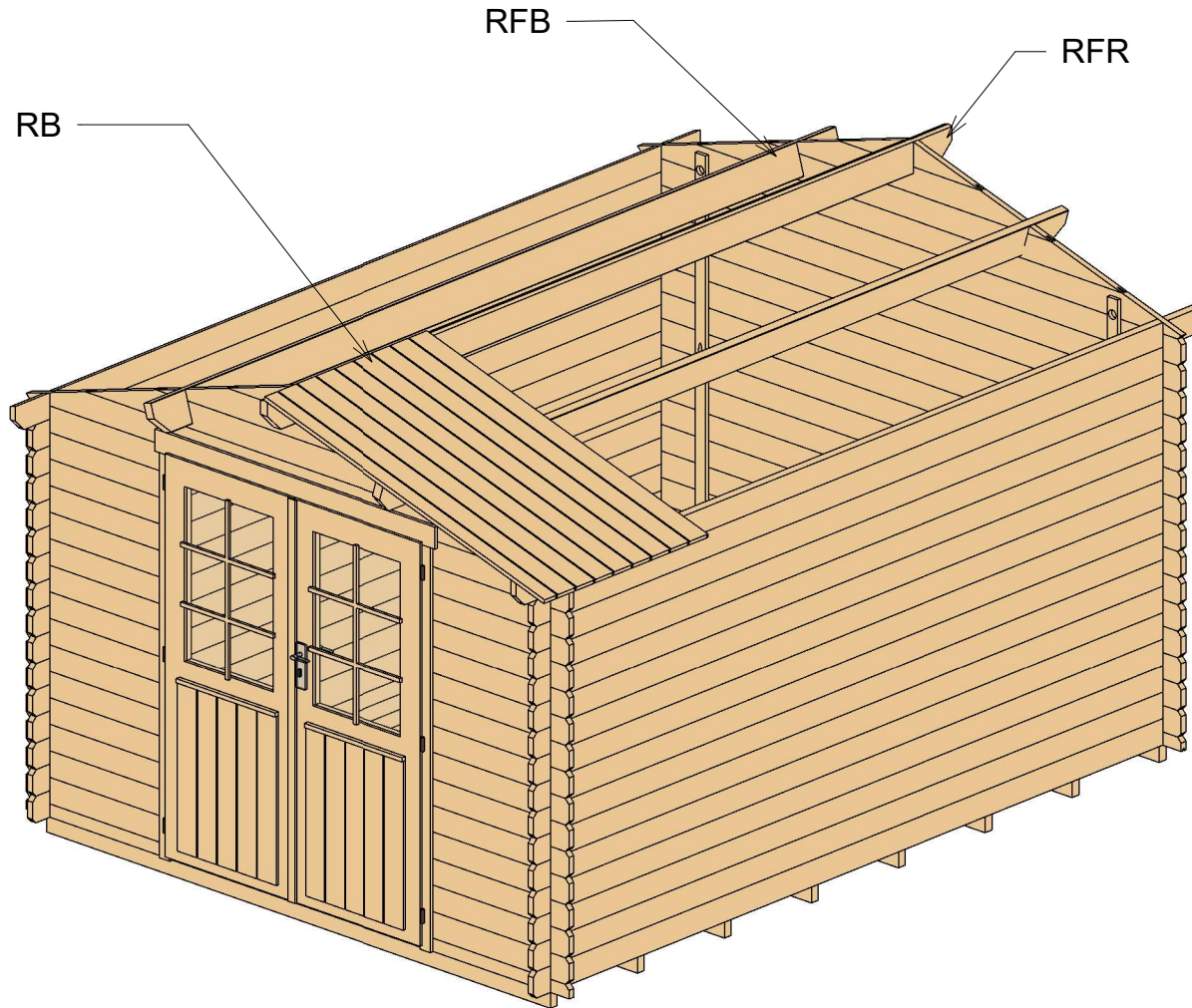
Denver 4 1 1/8" (108 1/4"x141 3/4")

Roof 1



Roof				
Mark	Type	Profile	Count	Length
RFB	Beam 40x143		2	157 1/2"
RFR	Ridge 40x143		1	157 1/2"
RB	Roofboard 18x110		76	62 5/8"

Denver 4 1 1/8" (108 1/4"x141 3/4")

Roof 2

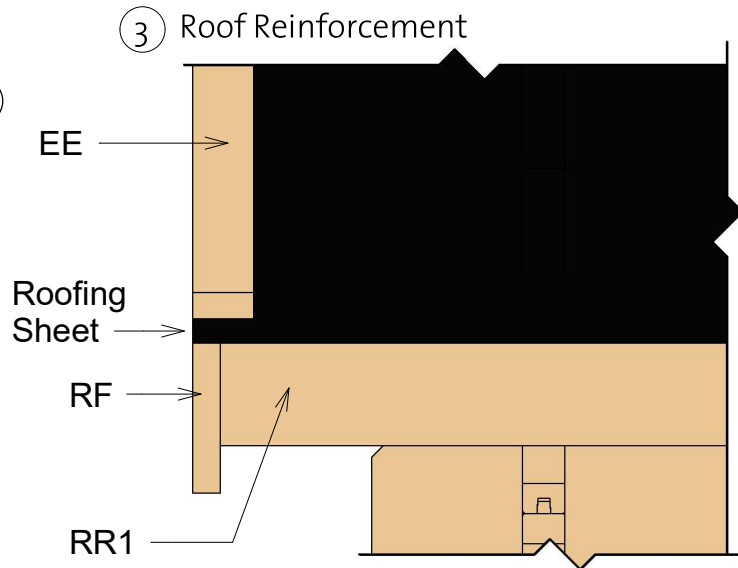
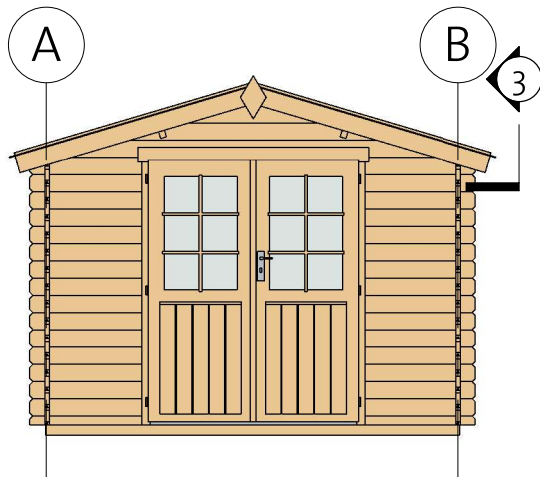
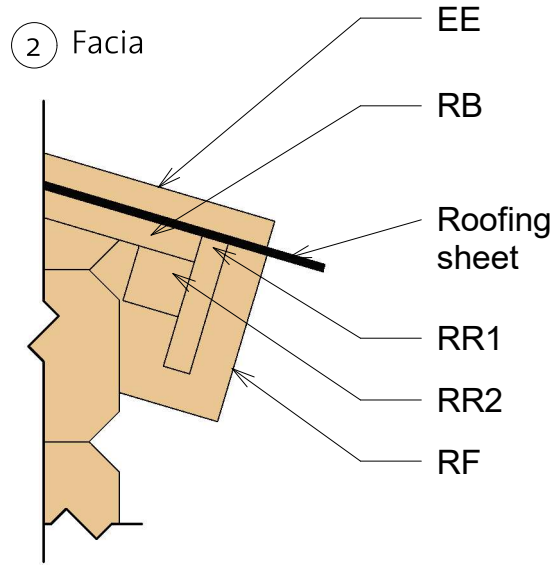
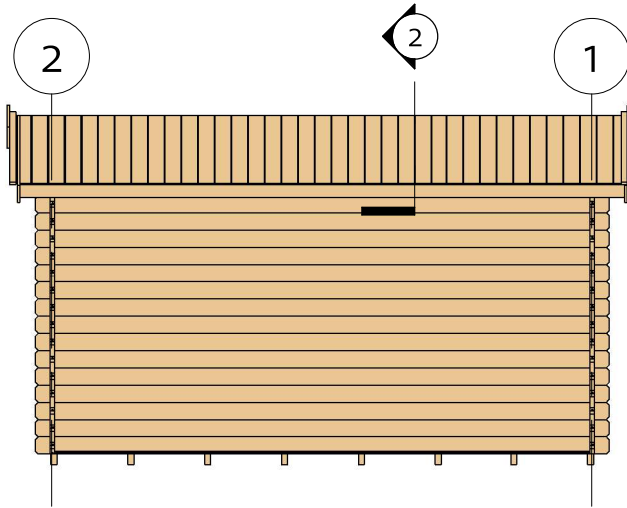

Fascia Schedule				
Mark	Type	Profile	Count	Length
EE	Eave Edging 18x40		4	64 9/16"
RF	Roof Fascia 18x115		4	64 9/16"
RR1	Roof reinforcement 18x90		2	157 1/2"
RR2	Roof reinforcement 38x38		2	157 1/2"

Denver 4 1 1/8" (108 1/4" x 141 3/4")

Extras

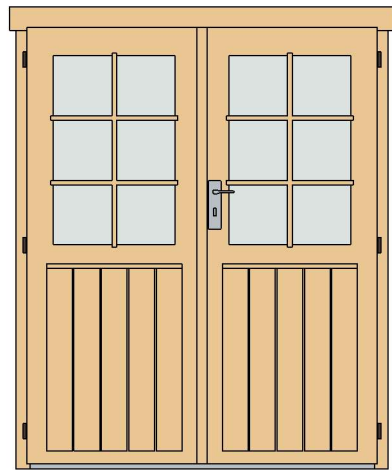

Door Schedule				
Model	Type	Width	Height	Count
BDD3R	Basic double door 3 right	56 1/8"	69 7/8"	1
DCB6	Door crossbar 6	--	--	2



Type	Count	Length
Windboard 18x40	4	86 5/8"

Fasteners/Extras		
Name	Type	Count



Family	Count
--------	-------

Romb	2
------	---

Hitblock	11 13/16"-15 3/4"	
Screws	3/16" x 2 3/4"	10
Bolts	M5/16" x 2 3/8"	12
Screws	1/4" x 5 1/2"	35
Nails	1/16" x 1 9/16"	35
Screws	3/16" x 1 9/16"	65
Screws	3/16" x 2"	470

Denver 4 1 1/8" (108 1/4"x141 3/4")

List of all items 1



Impregnated foundation beams

Mark	Type	Profile	Count	Length
------	------	---------	-------	--------

IFB	IFB 40x70		8	107 7/8"
-----	--------------	---	---	-------------



Floor Schedule

Mark	Type	Profile	Count	Length
------	------	---------	-------	--------

FB	FB 18x110		26	139 3/8"
BB1	BB 40x20		2	141 3/4"
BB2	BB 40x20		2	108 1/4"





Roof

Mark	Type	Profile	Count	Length
------	------	---------	-------	--------

RFB	Beam 40x143		2	157 1/2"
RFR	Ridge 40x143		1	157 1/2"
RB	Roofboard 18x110		76	62 5/8"

Fascia Schedule

Mark	Type	Profile	Count	Length
------	------	---------	-------	--------

EE	Eave Edging 18x40		4	64 9/16"
RF	Roof Fascia 18x115		4	64 9/16"
RR1	Roof reinforcement 18x90		2	157 1/2"
RR2	Roof reinforcement 38x38		2	157 1/2"

Denver 4 1 1/8" (108 1/4"x141 3/4")

List of all items 2

Wall 1			
Mark	Profile	Count	Cut Length

1BL 1	28x57	2	29 13/16"
1LG 1	28x114	30	29 13/16"
1LG 2*	28x114	1	30 7/16"
1LG 3*	28x114	1	60 3/4"
1LG 4*	28x114	1	91 1/16"
1LG 5*	28x114	1	116 1/8"

Wall 2			
Mark	Profile	Count	Cut Length

2BL 1	28x57	1	116 1/8"
2LG 1*	28x114	1	30 7/16"
2LG 2*	28x114	1	60 3/4"
2LG 3*	28x114	1	91 1/16"
2LG 4*	28x114	1	116 1/8"
2LG 5	28x114	15	116 1/8"

Wall A			
Mark	Profile	Count	Cut Length



ALG 1	28x114	15	149 5/8"
ATL 1	28x115	1	157 1/2"

Wall B			
Mark	Profile	Count	Cut Length

BLG 1	28x114	15	149 5/8"
BTL 1	28x115	1	157 1/2"

* Gable - delivered premounted

Log Profiles	
Profile	Profile

28x57	
28x114	

Log Profiles	
Profile	Profile

28x115	
--------	---