

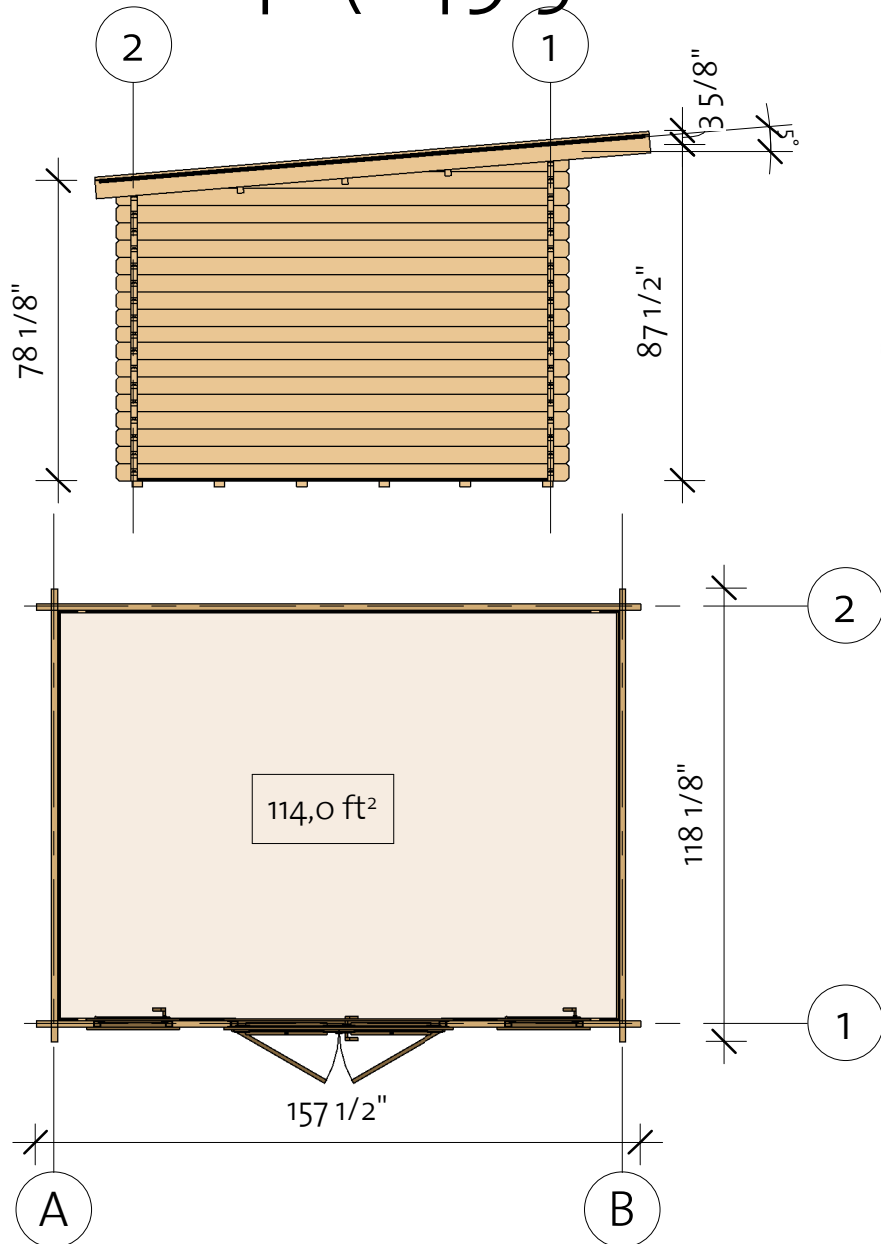

Rosa 2 40 (149 5/8" x 110 1/4")



Rosa 2 40(149 5/8"x110 1/4")

Foundation

Impregnated foundation beams				
Mark	Type	Profile	Count	Length

IFB	IFB 70x40		6	149 1/4"
-----	--------------	---	---	-------------

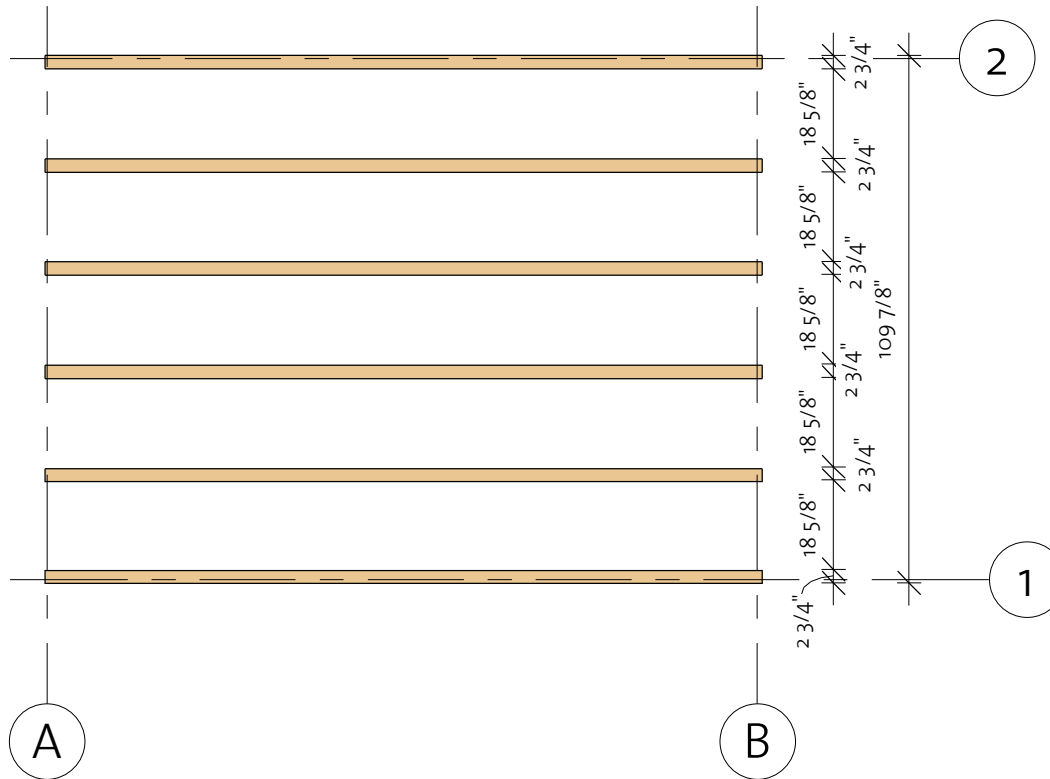

Rosa 2 40 (149 5/8" x 110 1/4")

Floor Plan

① Baseboard

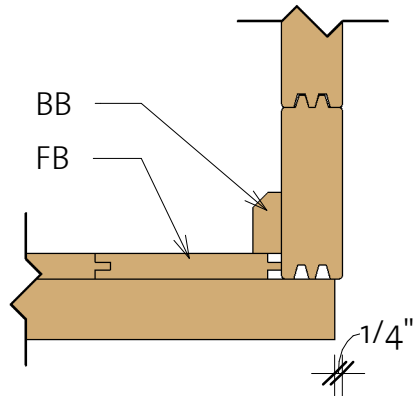

Floor Schedule

Mark	Type	Profile	Count	Length
------	------	---------	-------	--------

FB	FB 17x114		34	107"
----	-----------	---	----	------

BB1	BB 20x40		2	149 5/8"
BB2	BB 20x40		2	110 1/4"

200403

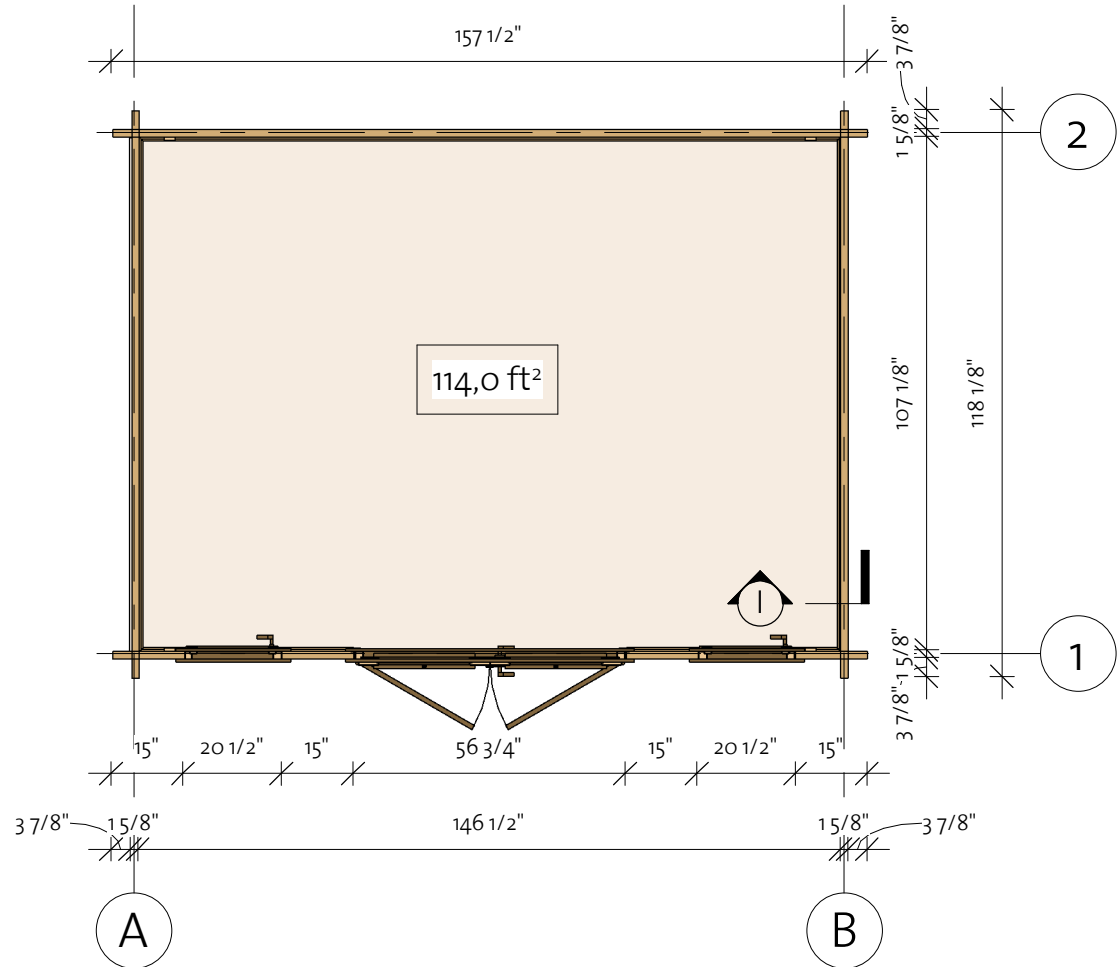

Rosa 2 40(149 5/8"x110 1/4")

Wall 1

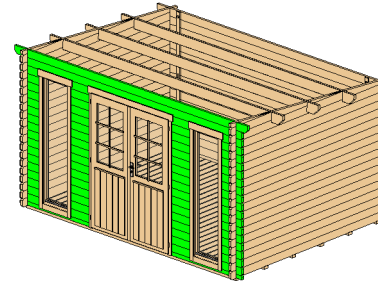

Wall 1			
Mark	Profile	Count	Cut Length

1BL-1	40X57	2	50 3/8"
1LG-1	40X114	34	15"
1LG-2	40X114	34	15"
1LG-3	40X114	1	157 1/2"
1TL-1	40X114	1	165 3/8"

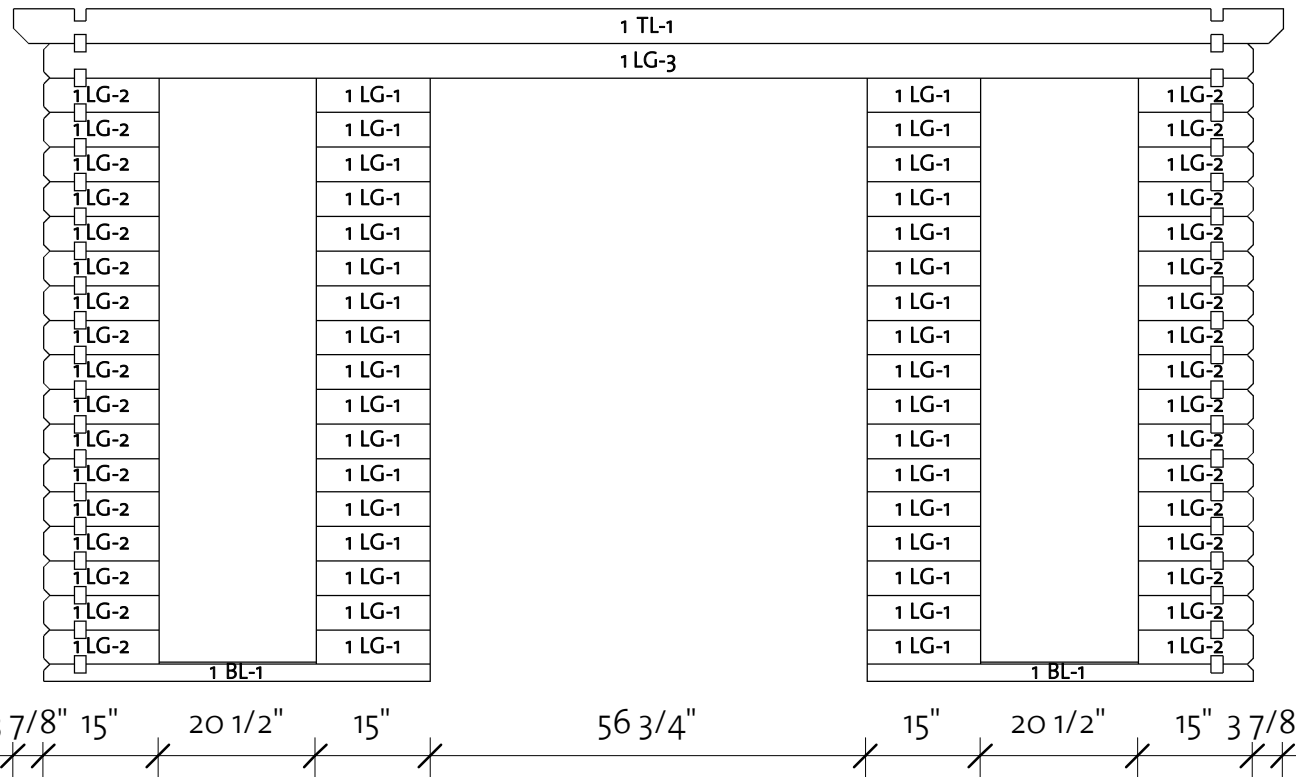

Log Profile Wall 1	
Profile	Profile

40X57	
40X114	
40X114	

Rosa 2 40(149 5/8"x110 1/4")

Wall 2

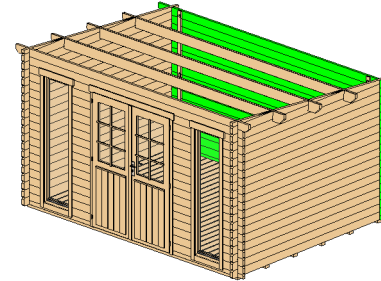

Wall 2			
Mark	Profile	Count	Cut Length

2BL-1	40X57	1	157 1/2"
2LG-1	40X114	16	157 1/2"
2TL-1	40X114	1	165 3/8"

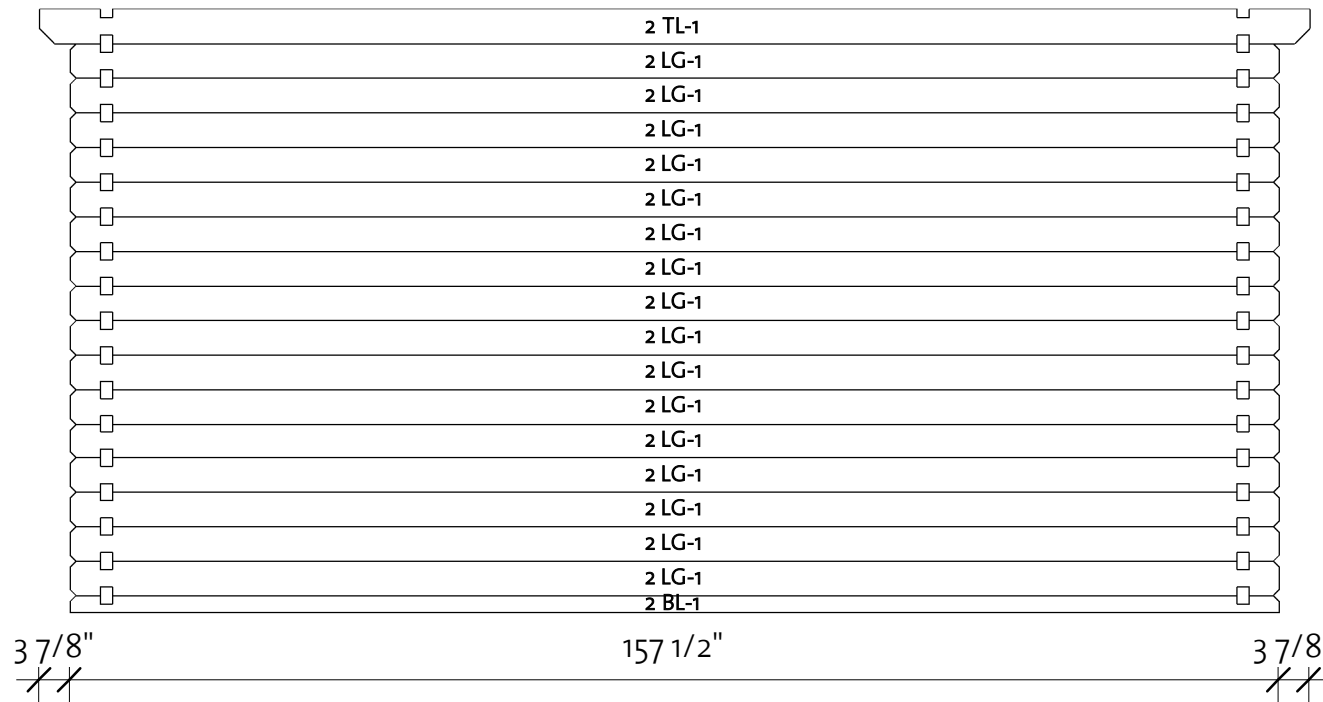

Log Profile Wall 2	
Profile	Profile

40X57	
40X114	
40X114	

Rosa 2 40(149 5/8"x110 1/4")

Wall A

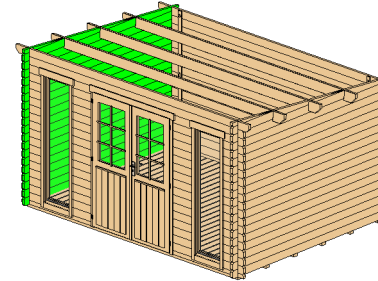

Wall A			
Mark	Profile	Count	Cut Length

ALG-1	40x114	17	118 1/8"
ALG-2*	40x114	1	118 1/8"
ALG-3*	40x114	1	85 1/4"
ALG-4*	40x114	1	31"

* Gable - delivered premounted

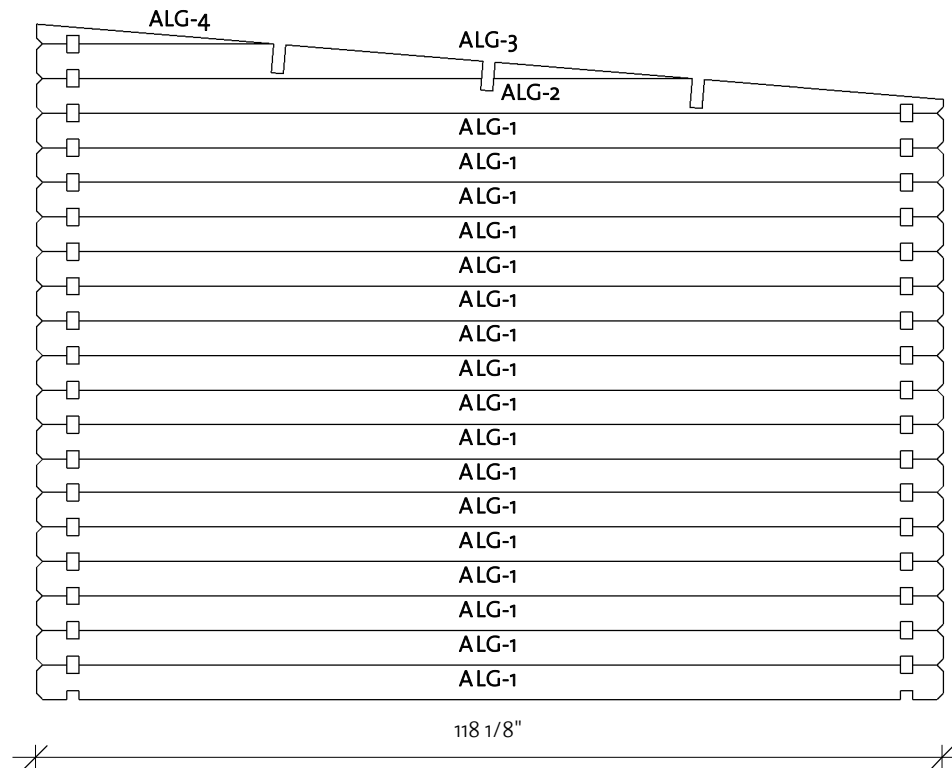

Log Profile Wall A	
Profile	Profile

40x114	
--------	--

Rosa 2 40(149 5/8"x110 1/4")

Wall B

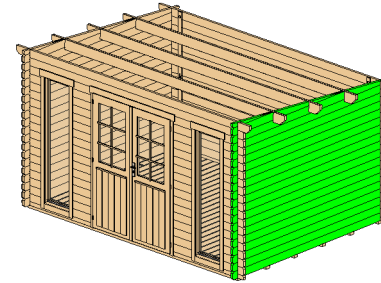

Wall B			
Mark	Profile	Count	Cut Length

BLG-1	40X114	17	118 1/8"
BLG-2*	40X114	1	118 1/8"
BLG-3*	40X114	1	85 1/4"
BLG-4*	40X114	1	31"

* Gable - delivered premounted

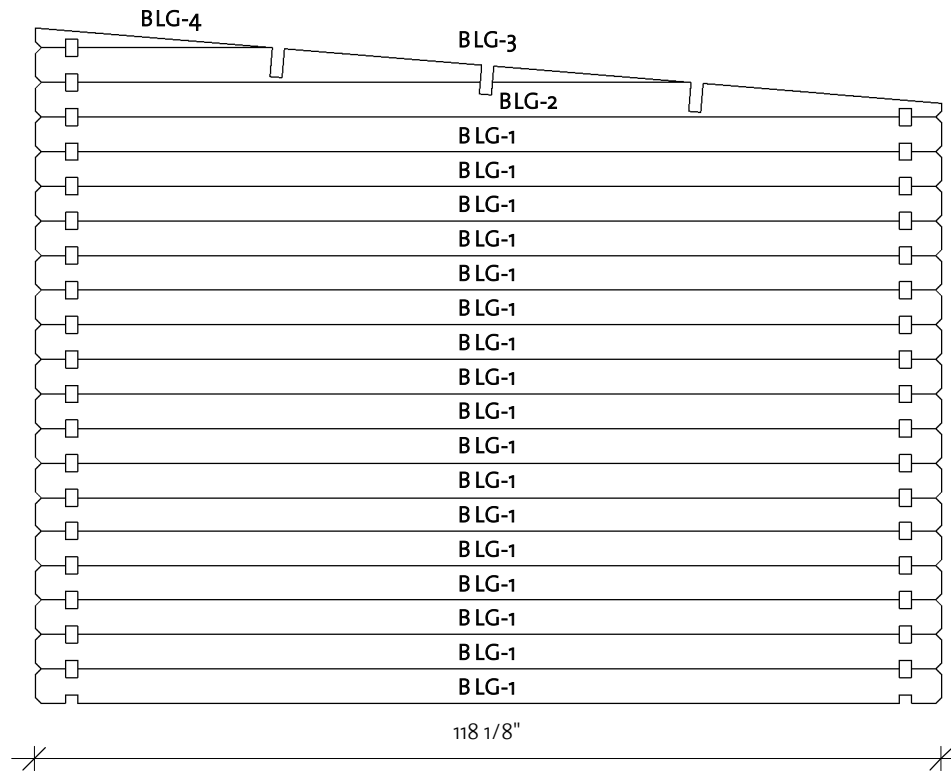



Log Profile Wall B	
Profile	Profile

40X114	
--------	--

Rosa 2 40(149 5/8"x110 1/4")

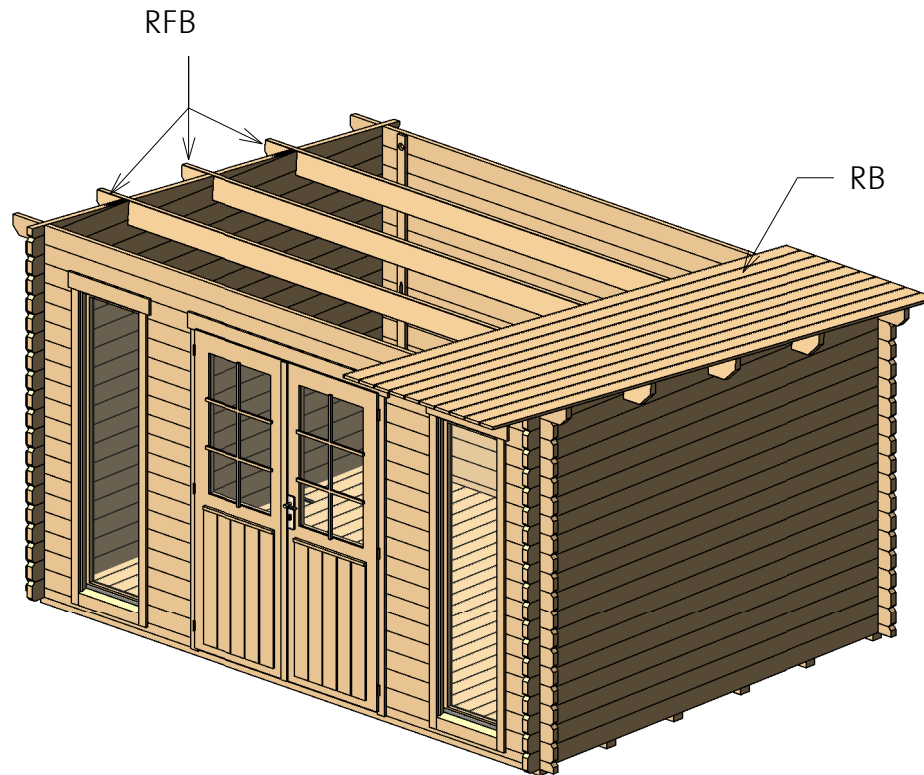
Roof 1



Roof				
Mark	Type	Profile	Count	Length
RFB	Beam 40x143		3	165 3/8"
RB	17x114		38	142 1/2"

Rosa 2 40(149 5/8"x110 1/4")

Roof 2

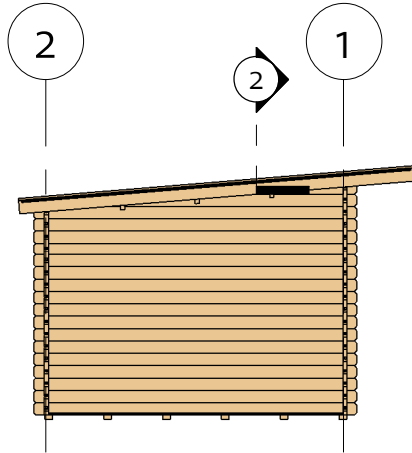

② Facia

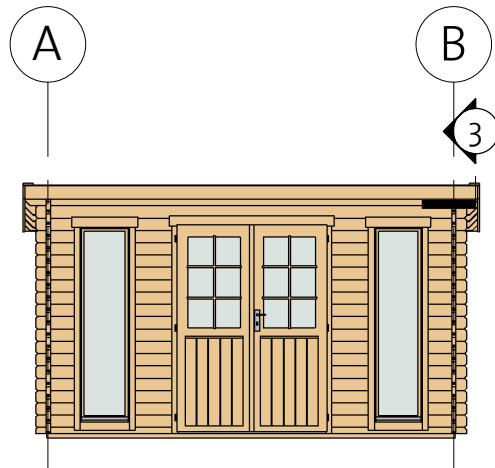
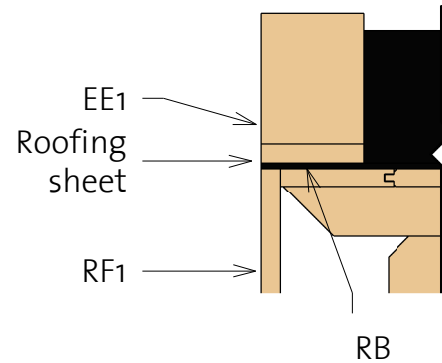

③ Roof Reinforcement

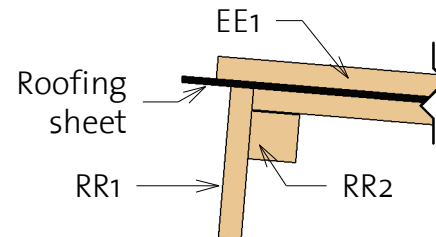

Fascia Schedule

Mark	Type	Profile	Count	Length
RR1	Roof reinforcement 18x120		2	165 3/8"
RR2	Roof reinforcement 38x38		2	165 3/8"
RF1	Roof Fascia 18x120		2	144 7/8"
EE1	Eave Edging 18x95		2	144 7/8"

Rosa 2 40(149 5/8"x110 1/4")

Extras

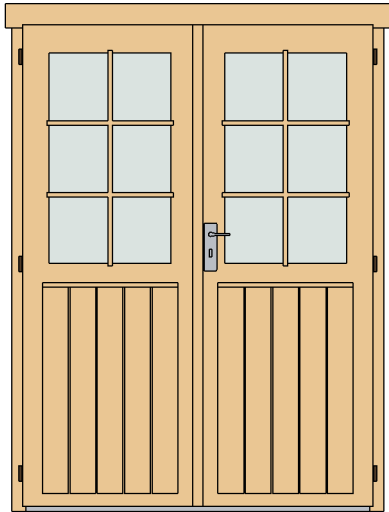

Door Schedule				
Mark	Type	Width	Height	Count
CDD1R	Classic double door 1 right	56 1/8"	77"	1
DCB6	Door Crossbar 6	--	--	1/8"

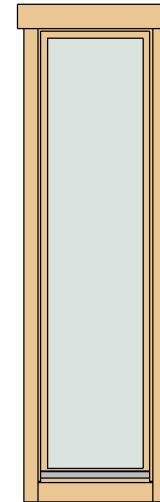

Window Schedule				
Mark	Type	Width	Height	Count
CW21R	Classic window 21 right	20 1/4"	74 3/8"	2
WCB8	Windows Crossbar 8 optional	--	--	2

Fasteners & Extras		
Name	Type	Count

Screws	4,0 x 40	520
Screws	5,0 x 70	15
Hitblock	300-400 mm	
Screws	6,0 x 140	40
Bolts	M8 x 70	12
Nails	1,4 x 40	25



Type	Length	Count
------	--------	-------

Windboard 18x40	2200	4
--------------------	------	---

- * Windows intended for tilt opening only!
- * Fenster zur Eröffnung nur zum Kippen vorgesehen!
- * Aknad on ette nähtud ainult kaldu avamiseks!

Rosa 2 40(149 5/8"x110 1/4")

List of all items 1

Floor Schedule				
Mark	Type	Profile	Count	Length

FB	FB 17x114		34	107"
----	-----------	---	----	------

BB1	BB 20x40		2	149 5/8"
-----	----------	---	---	----------

BB2	BB 20x40		2	110 1/4"
-----	----------	--	---	----------

Impregnated foundation beams				
Mark	Type	Profile	Count	Length

Mark	Type	Profile	Count	Length
------	------	---------	-------	--------

IFB	IFB 70x40		6	149 1/4"
-----	-----------	---	---	----------

Roof				
Mark	Type	Profile	Count	Length

Mark	Type	Profile	Count	Length
------	------	---------	-------	--------

RFB	Beam 40x143		3	165 3/8"
-----	-------------	---	---	----------

RB	17x114		38	142 1/2"
----	--------	---	----	----------

Fascia Schedule				
Mark	Type	Profile	Count	Length

Mark	Type	Profile	Count	Length
------	------	---------	-------	--------

RR1	Roof reinforcement 18x120		2	165 3/8"
-----	---------------------------	---	---	----------

RR2	Roof reinforcement 38x38		2	165 3/8"
-----	--------------------------	---	---	----------

RF1	Roof Fascia 18x120		2	144 7/8"
-----	--------------------	---	---	----------

EE1	Eave Edging 18x95		2	144 7/8"
-----	-------------------	---	---	----------

Rosa 2 40(149 5/8"x110 1/4")

List of all items 2

Wall 1			
Mark	Profile	Count	Cut Length

1BL-1	40x57	2	50 3/8"
1LG-1	40x114	34	15"
1LG-2	40x114	34	15"
1LG-3	40x114	1	157 1/2"
1TL-1	40x114	1	165 3/8"

Wall 2			
Mark	Profile	Count	Cut Length

2BL-1	40x57	1	157 1/2"
2LG-1	40x114	16	157 1/2"
2TL-1	40x114	1	165 3/8"

Wall A			
Mark	Profile	Count	Cut Length



ALG-1	40x114	17	118 1/8"
ALG-2*	40x114	1	118 1/8"
ALG-3*	40x114	1	85 1/4"
ALG-4*	40x114	1	31"

Wall B			
Mark	Profile	Count	Cut Length

BLG-1	40x114	17	118 1/8"
BLG-2*	40x114	1	118 1/8"
BLG-3*	40x114	1	85 1/4"
BLG-4*	40x114	1	31"

* Gable - delivered premounted

Log Profiles	
Profile	Profile

40x57	
40x114	

Log Profiles	
Profile	Profile

40x114	
--------	---