

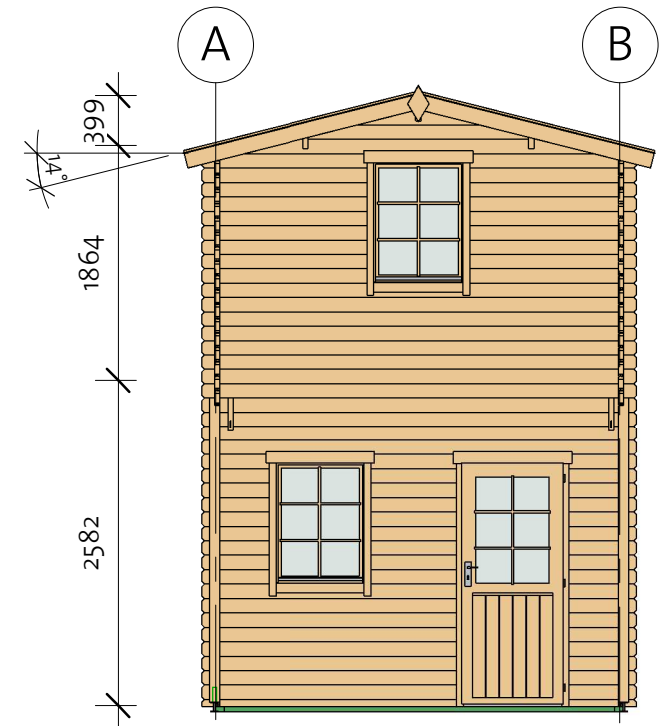

# Highland Bunkie 40 (325x294)

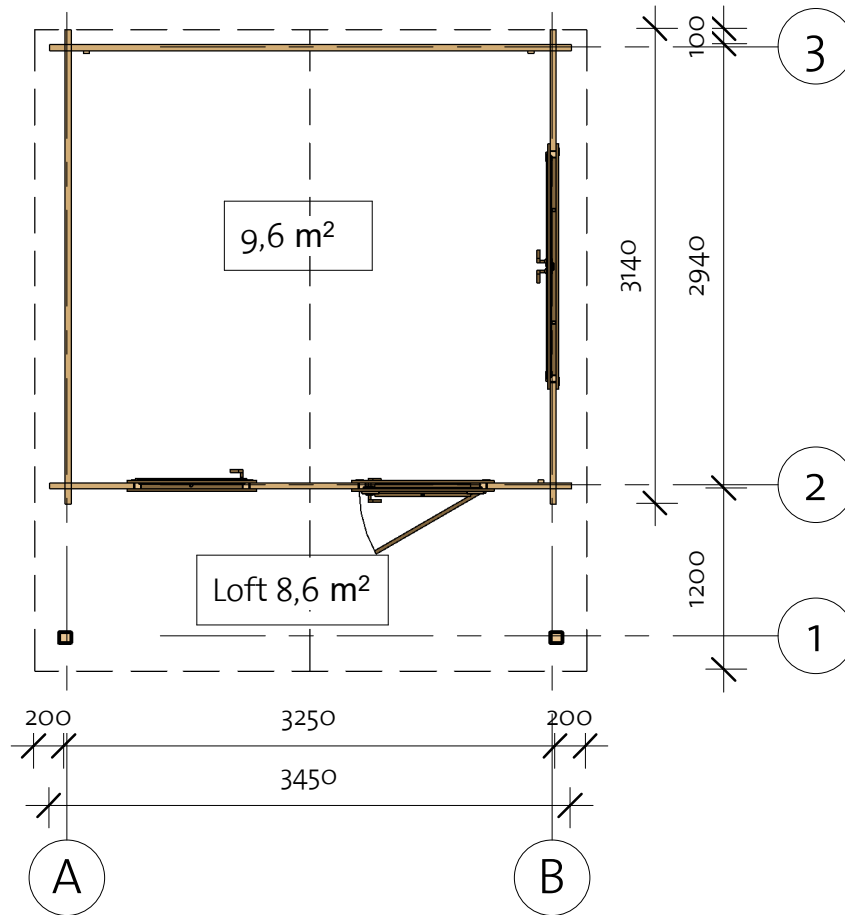

# Highland Bunkie 40 (325x294)

Foundation

Impregnated foundation beams				
Mark	Type	Profile	Count	Length

IFB1	IFB 70x40		2	2930
IFB2	IFB 70x40		7	3100

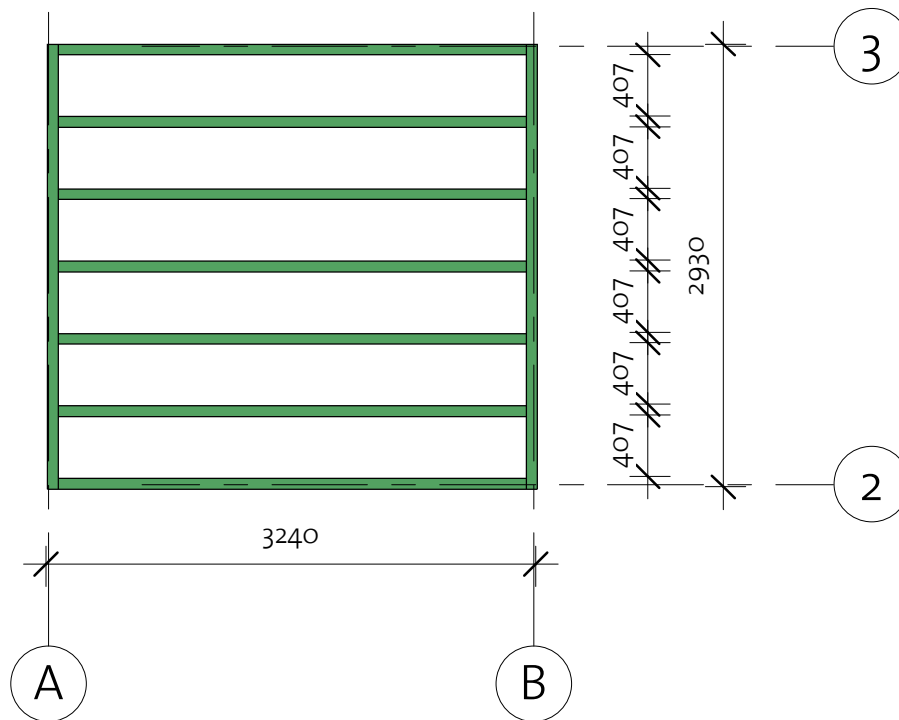

# Highland Bunkie 40 (325x294)

Floor Plan

① Baseboard

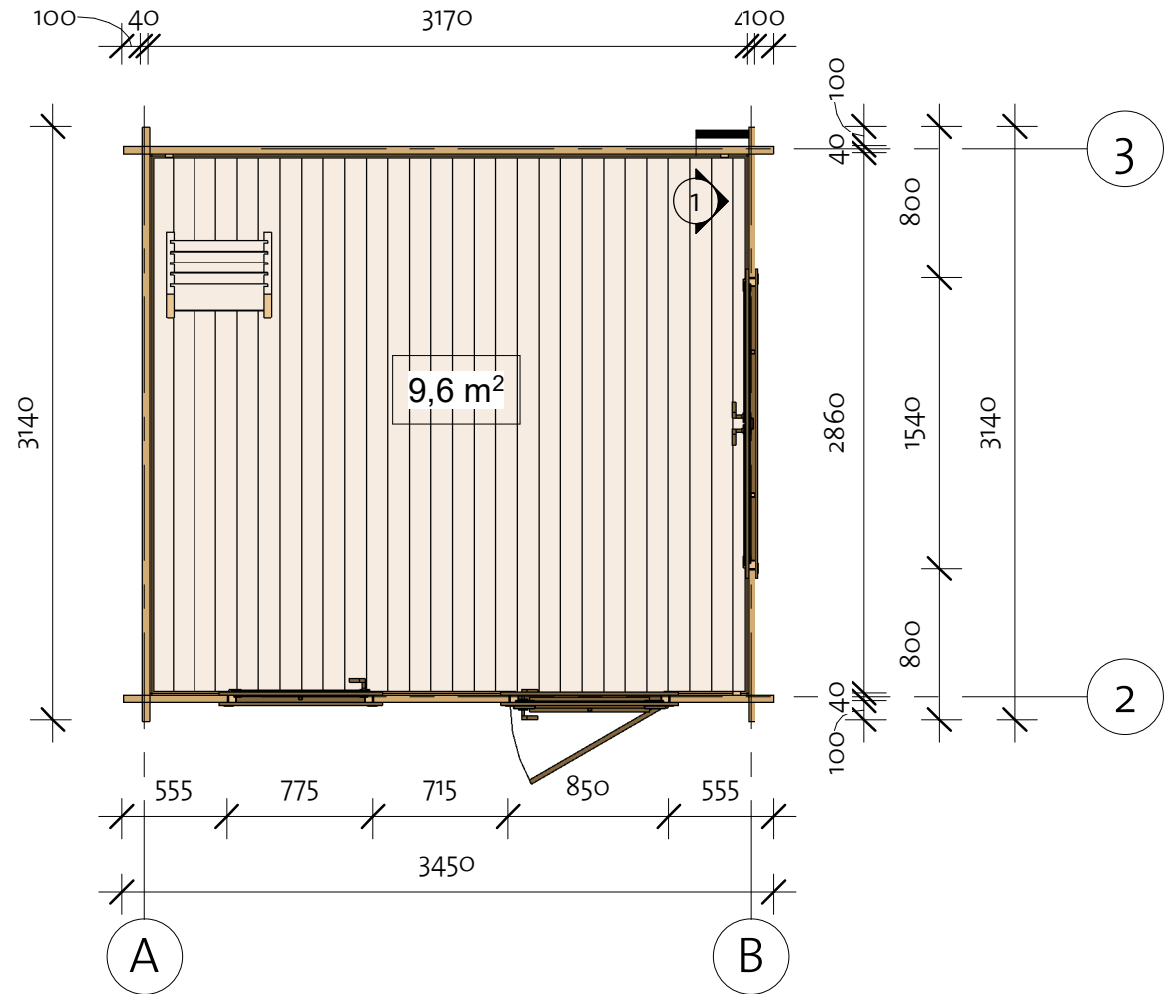
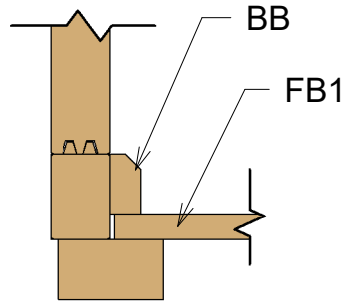

Floor Schedule

Mark	Type	Profile	Count	Length
------	------	---------	-------	--------

FB1	FB 17x114		29	2854
-----	-----------	--	----	------

BB1	BB 20x40		4	2900
BB2	BB 20x40		3	3200

# Highland Bunkie 40 (325x294)

Wall 1

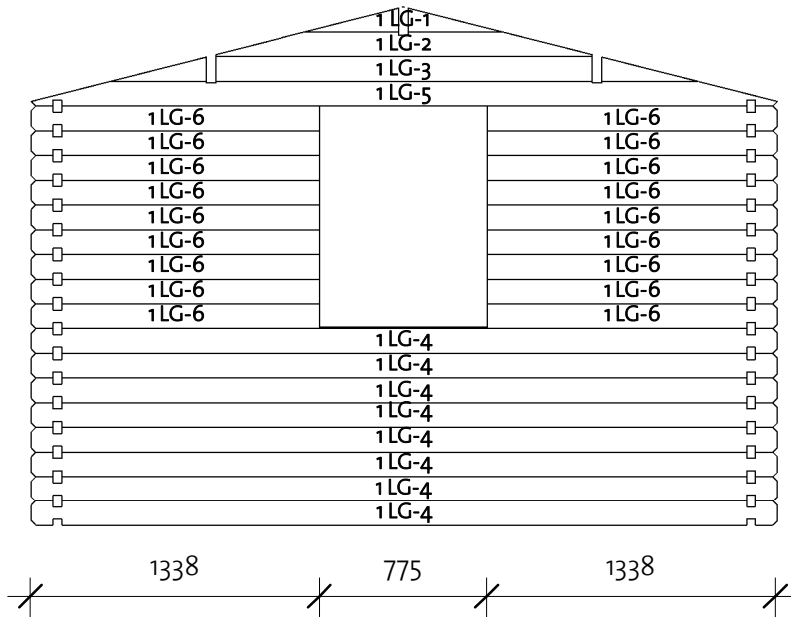
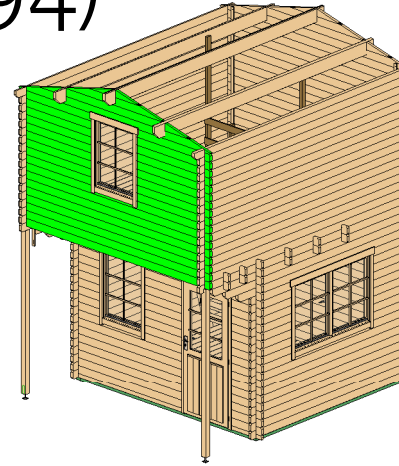

Wall 1			
Mark	Profile	Count	Cut Length

1LG-1 *	40X114	1	913
1LG-2 *	40X114	1	1743
1LG-3 *	40X114	1	2719
1LG-4	40X114	8	3450
1LG-5 *	40X114	1	3450
1LG-6	40X114	18	1338

\* Gable - delivered premounted

Log Profile Wall 1	
Profile	Profile

40X114	
--------	--

# Highland Bunkie 40 (325x294)

Wall 2

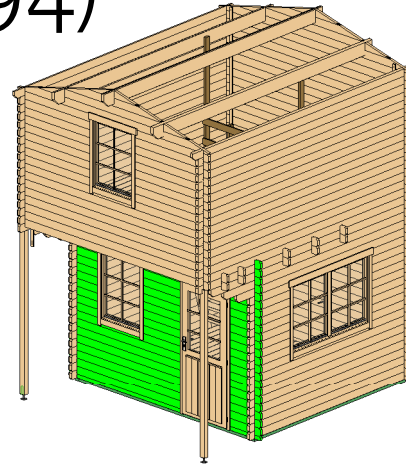

Wall 2			
Mark	Profile	Count	Cut Length

2BL-1	40X57	1	555
2BL-2	40X57	1	2045
2LG-1	40X114	26	555
2LG-2	40X114	1	3450
2LG-3	40X114	9	715
2LG-4	40X114	8	2045
2LG-5	40X114	4	3450

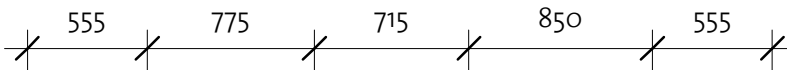
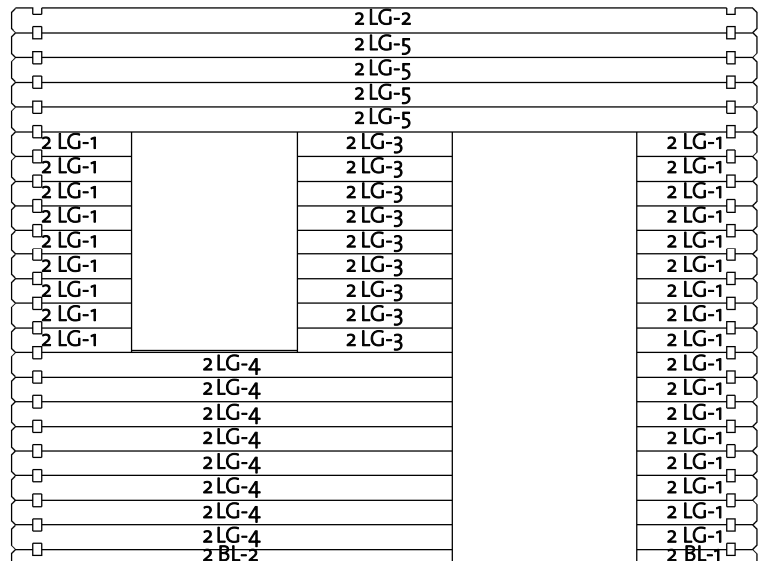

Log Profile Wall 2	
Profile	Profile

40X57	
40X114	
40X114	



# Highland Bunkie 40 (325x294)

Wall A

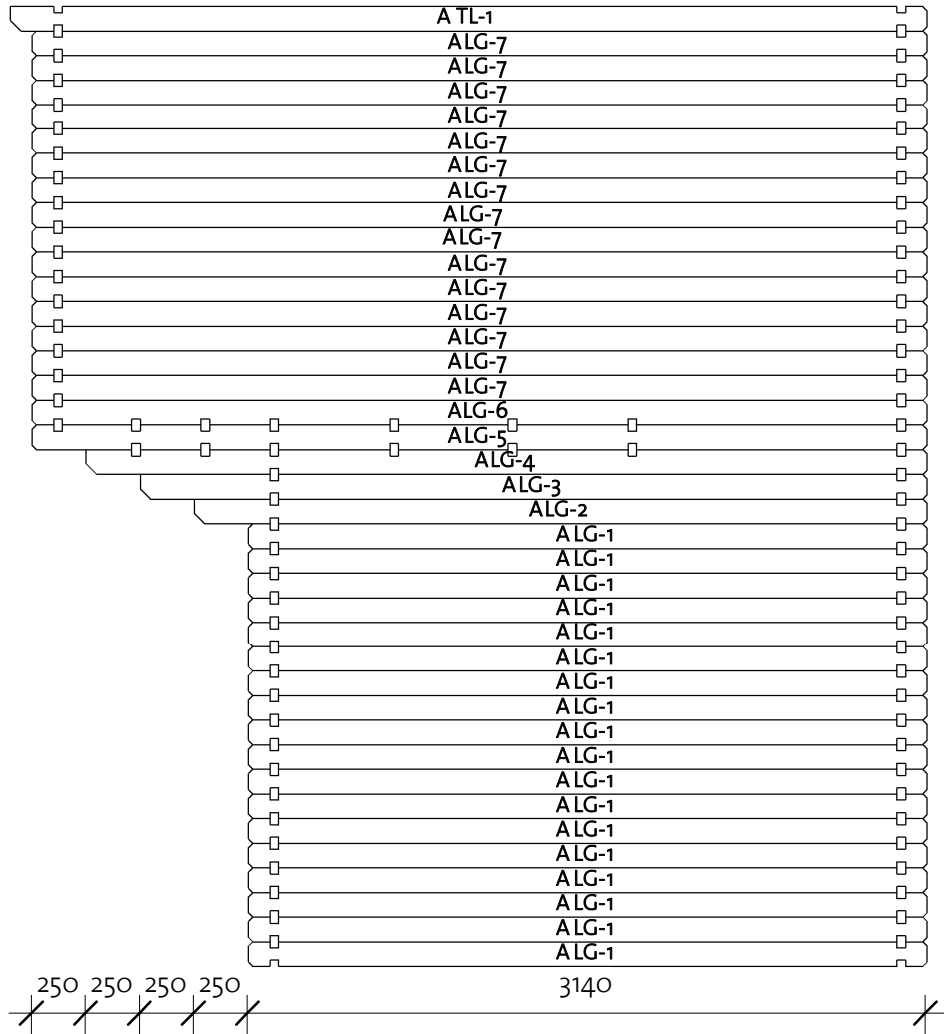
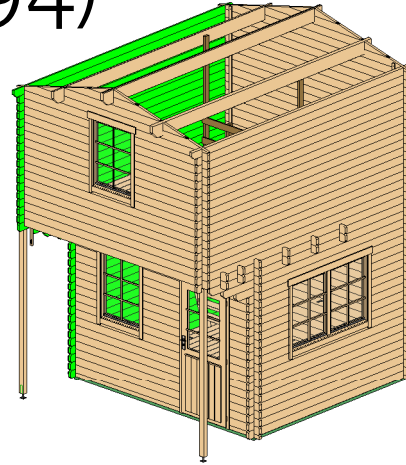

Wall A			
Mark	Profile	Count	Cut Length

ALG-1	40X114	18	3140
ALG-2	40X114	1	3390
ALG-3	40X114	1	3640
ALG-4	40X114	1	3890
ALG-5	40X114	1	4140
ALG-6	40X114	1	4140
ALG-7	40X114	15	4140
ATL-1	40X114	1	4240

Log Profile Wall A	
Profile	Profile

40X114	
40X114	

# Highland Bunkie 40 (325x294)

Wall B

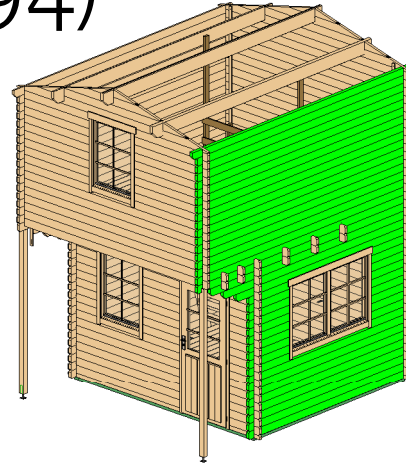

Wall B			
Mark	Profile	Count	Cut Length

BLG-1	40X114	18	800
BLG-2	40X114	9	3140
BLG-3	40X114	1	3390
BLG-4	40X114	1	3640
BLG-5	40X114	1	3890
BLG-6	40X114	1	4140
BLG-7	40X114	1	4140
BLG-8	40X114	15	4140
BTL-1	40X114	1	4240

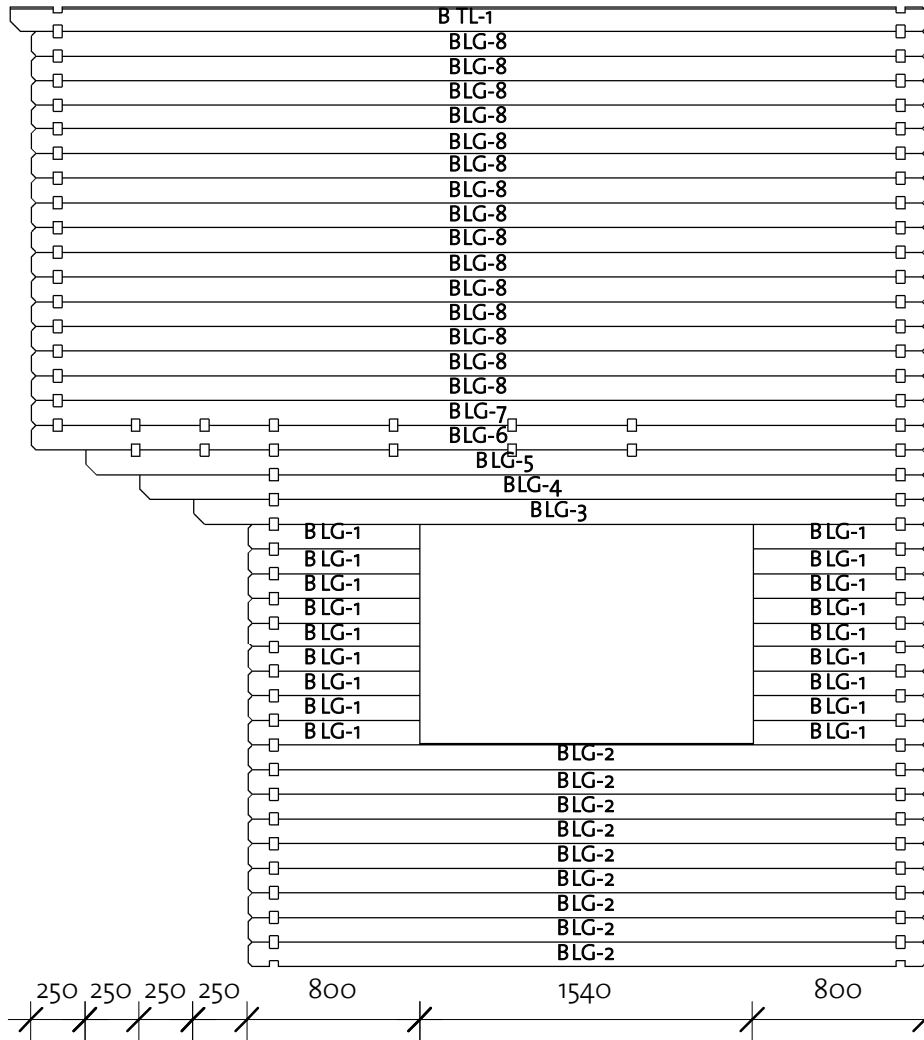

Log Profile Wall B	
Profile	Profile





40X114	
40X114	

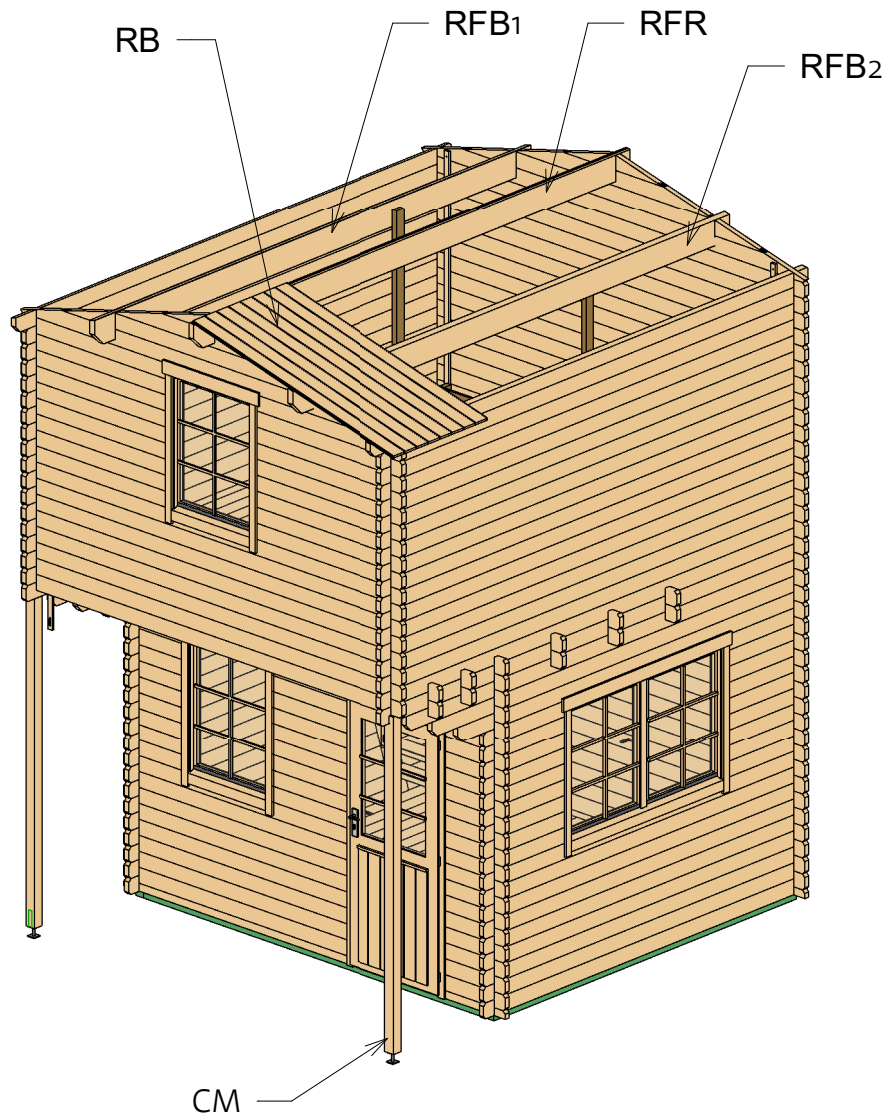

# Highland Bunkie 40 (325x294)

Roof 1



Roof				
Mark	Type	Profile	Count	Length
RFR	Ridge 45x195		1	4240
RFB1	Beam 45x195		1	4240
RFB2	Beam 45x195		1	4240
RB	17x114		76	1878

Columns			
Mark	Profile	Count	Length
CM	Post 80x70	2	2416

# Highland Bunkie 40 (325x294)

Roof 2

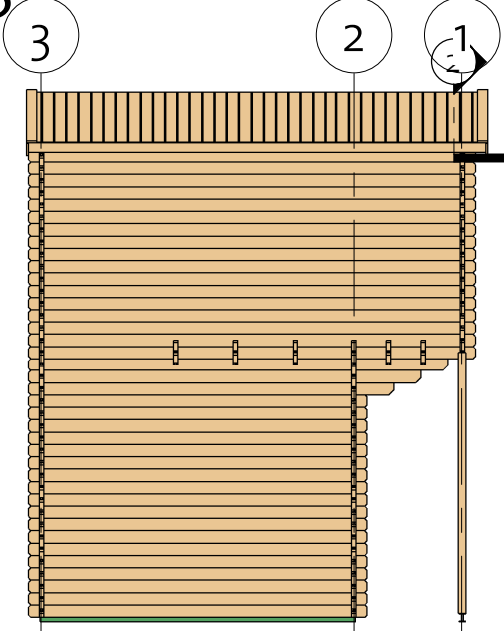

2) Facia

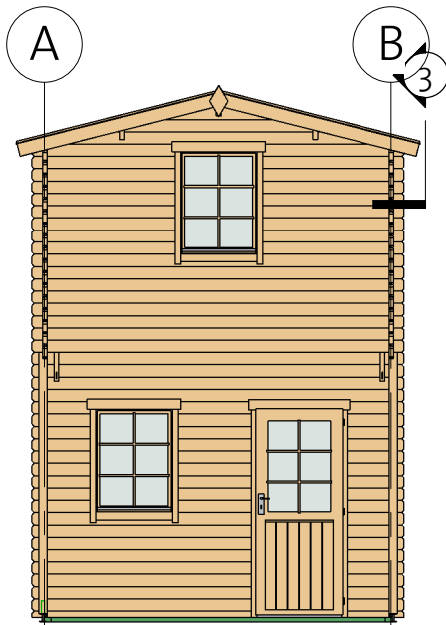
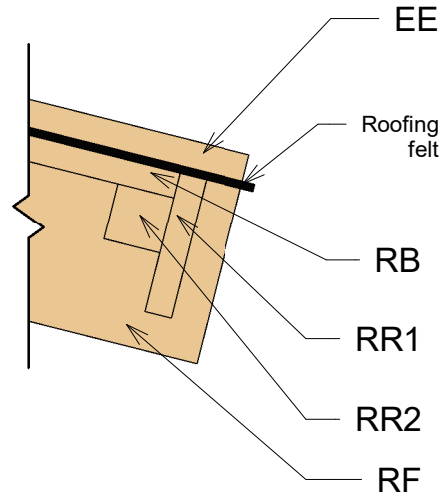

3) Roof Reinforcement

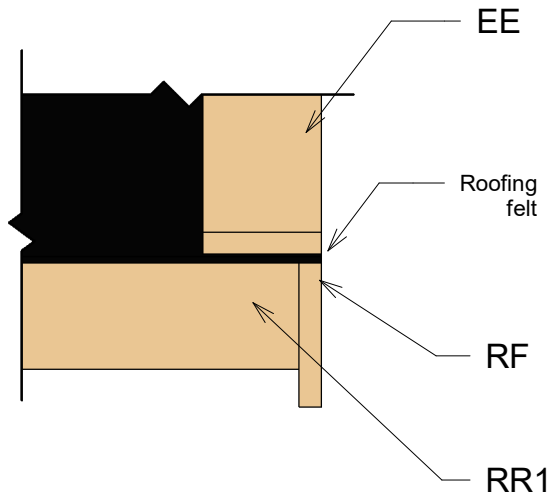



Fascia Schedule

Mark	Type	Profile	Count	Length
EE	Eave Edging 18x95		4	1924
RF	Roof Fascia 18x120		4	1924
RR1	Roof reinforce ment 18x95		2	4240
RR2	Roof reinforce ment 38x38		2	4240

# Highland Bunkie 40 (325x294)

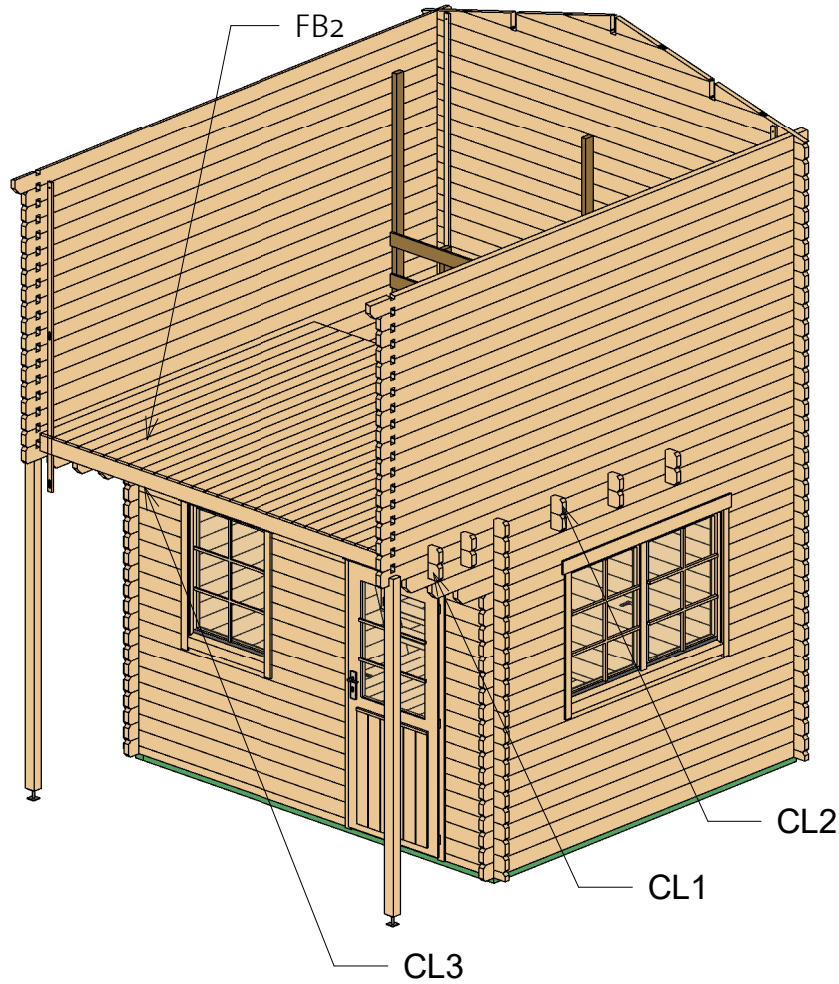
Second floor

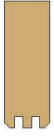

Second floor schedule				
Mark	Type	Profile	Length	Count
CL1	Log 40x114		3450	5
CL2	Log 40x114		3450	5
CL3	Log 40x114		3170	1

Second Floor Schedule				
Mark	Type	Profile	Count	Length
FB2	FB 17x114		29	2660

# Highland Bunkie 40 (325x294)

Fence

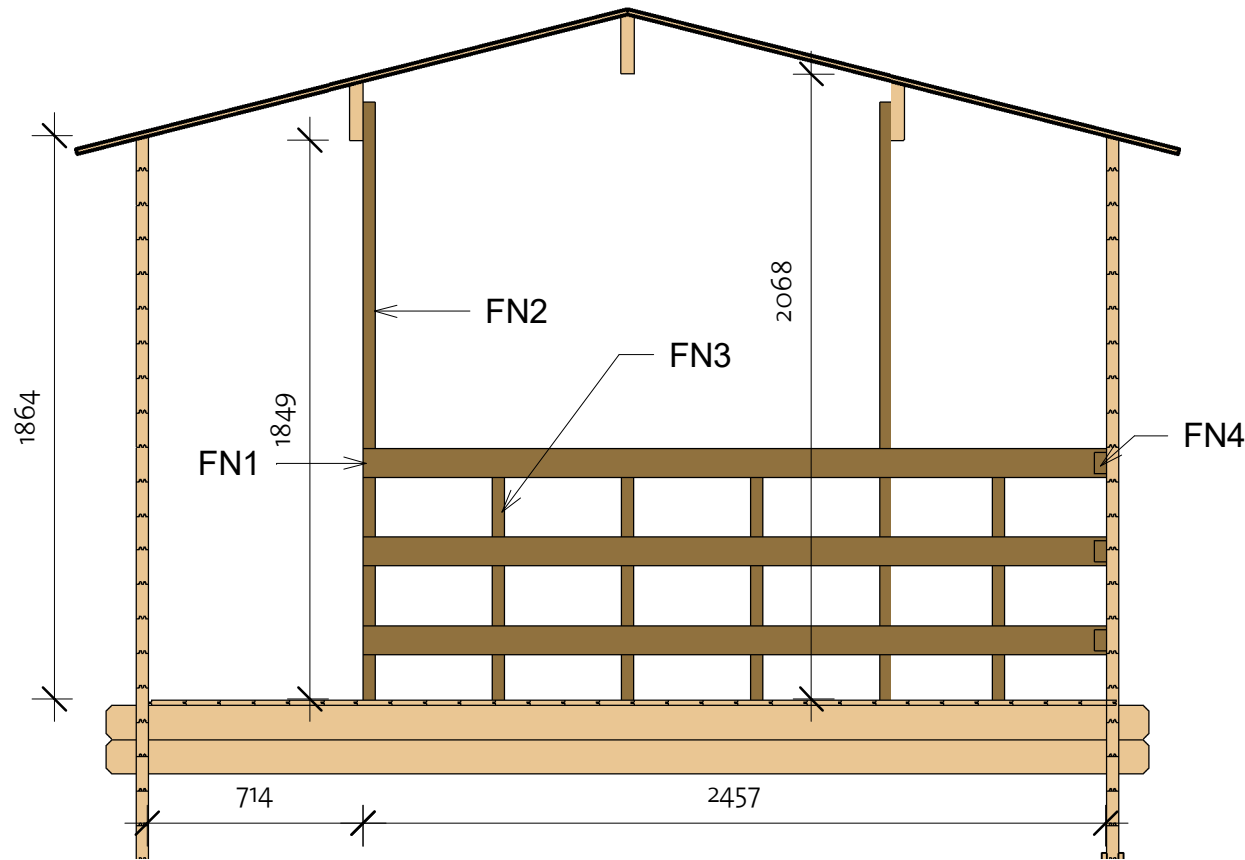



Fence schedule				
Mark	Type	Profile	Length	Count
FN1	Fence 18x95		2457	3
FN2	Fence 40x70		2220	2
FN3	Fence 40x70		1079	4
FN4	Fence 70x40		90	3

# Highland Bunkie 40 (325x294)

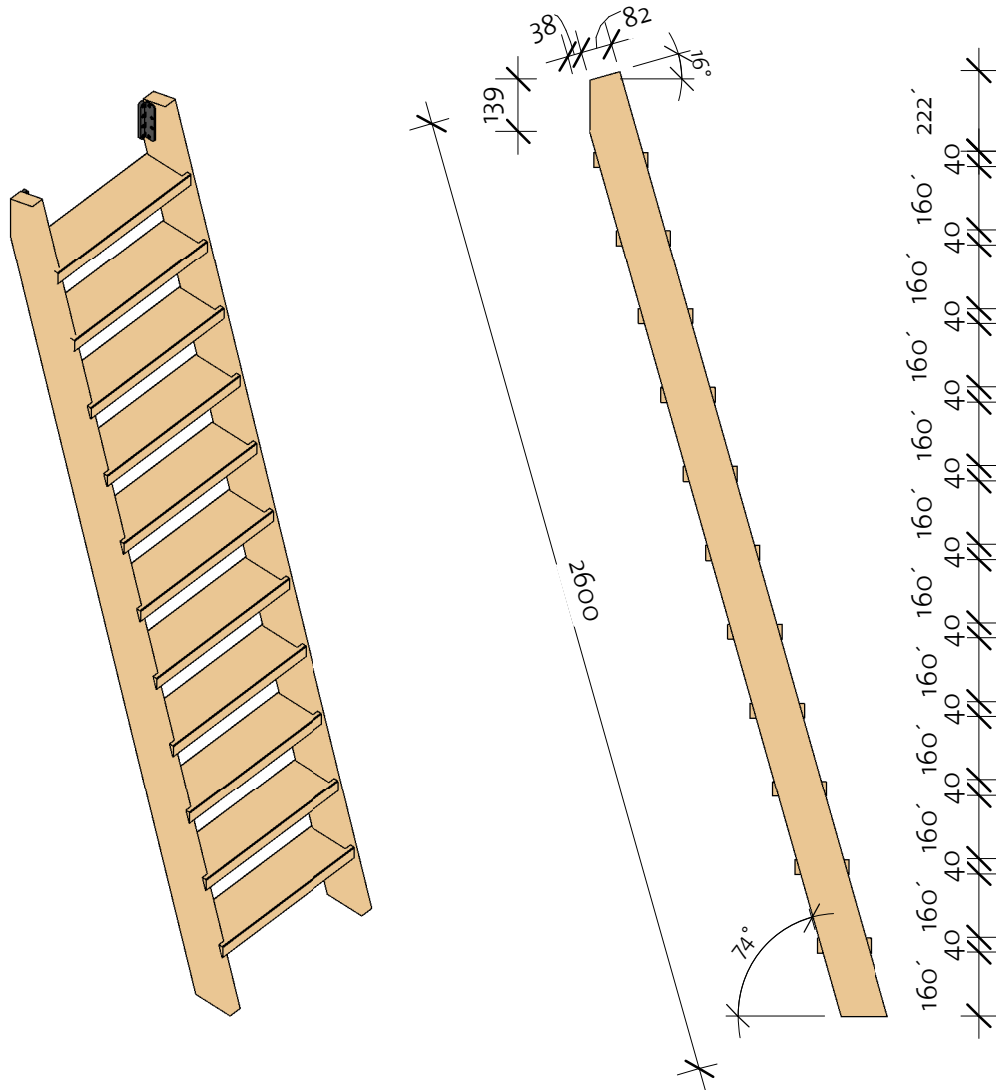
Stairs



Stairs				
Mark	Profile	Profile	Count	Cut Length
ST1L	Stair 40X120		1	2600
ST1R	Stair 40X120		1	2600
ST2	Stair 143X40		11	520

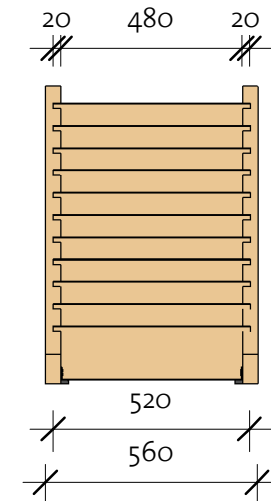

# Highland Bunkie 40 (325x294)

Extras

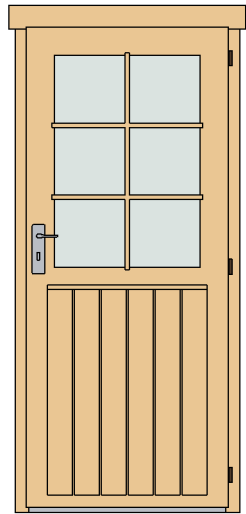

Door Schedule				
Model	Type	Width	Height	Count
CD4R	Classic door 4 right	840	1955	1
DCB6	Door Crossbar 6	--	--	1

Fasteners/Extras		
Name	Type	Count

Hitblock	300-400 mm	
Adjustable post foot		2
Ladder fittings		2
Bolts	M8x70	18
Screws	6,0 x 140	45
Nails	1,4 x 40	55
Screws	5,0 x 70	135
Screws	4,0 x 40	135
Screws	4,0 x 50	700

Window Schedule				
Mark	Type	Width	Height	Count
CDW1	Classic double window 1	1530	990	1
CW1R	Classic window 1 right	765	990	2
WCB6	Windows Crossbar 6	--	--	4

Type	Count	Length
------	-------	--------

Windboard 18x40 2200	2	2200
Windboard 18x40 4400	2	4400
Windboard 18x40x2500	2	2500

Type	Count
------	-------

Romb	2
------	---

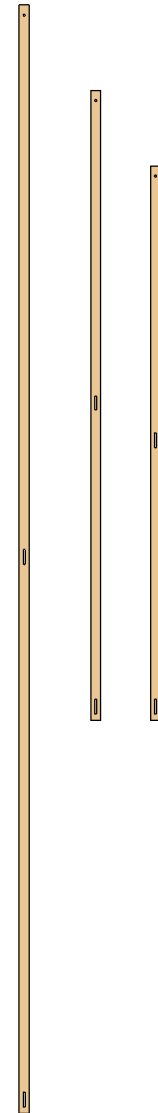
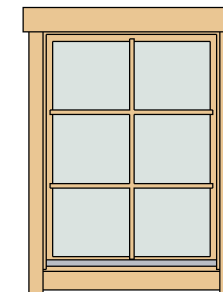
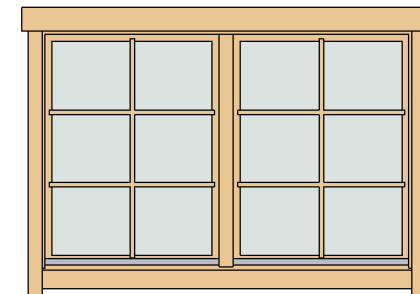





# Highland Bunkie 40 (325x294)

## List of all items 1

Impregnated foundation beams				
Mark	Type	Profile	Count	Length

IFB1	IFB 70x40		2	2930
IFB2	IFB 70x40		7	3100

Fascia Schedule				
Mark	Type	Profile	Count	Length

EE	Eave Edging 18x95		4	1924
RF	Roof Fascia 18x120		4	1924
RR1	Roof reinforce ment 18x95		2	4240
RR2	Roof reinforce ment 38x38		2	4240

Columns			
Mark	Profile	Count	Length



CM	Post 80x70	2	2416
----	------------	---	------

Floor Schedule				
Mark	Type	Profile	Count	Length

FB1	FB 17x114		29	2854
-----	-----------	---	----	------



BB1	BB 20x40		4	2900
BB2	BB 20x40		3	3200



Roof				
Mark	Type	Profile	Count	Length

RFR	Ridge 45x195		1	4240
RFB1	Beam 45x195		1	4240
RFB2	Beam 45x195		1	4240
RB	17x114		76	1878

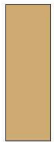
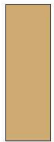
# Highland Bunkie 40 (325x294)

## List of all items 2

Stairs				
Mark	Profile	Profile	Count	Cut Length
ST1L	Stair 40x120		1	2600
ST1R	Stair 40x120		1	2600
ST2	Stair 143x40		11	520

Fence schedule				
Mark	Type	Profile	Length	Count
FN1	Fence 18x95		2457	3
FN2	Fence 40x70		2220	2
FN3	Fence 40x70		1079	4
FN4	Fence 70x40		90	3

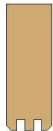
Second floor schedule				
Mark	Type	Profile	Length	Count
CL1	Log 40x114		3450	5
CL2	Log 40x114		3450	5
CL3	Log 40x114		3170	1

Second Floor Schedule				
Mark	Type	Profile	Count	Length
FB2	FB 17x114		29	2660



# Highland Bunkie 40 (325x294)

## List of all items 3

Wall 1			
Mark	Profile	Count	Cut Length

1LG-1*	40X114	1	913
1LG-2*	40X114	1	1743
1LG-3*	40X114	1	2719
1LG-4	40X114	8	3450
1LG-5*	40X114	1	3450
1LG-6	40X114	18	1338

Wall 3			
Mark	Profile	Count	Cut Length

3BL-1	40X57	1	3450
3LG-1*	40X114	1	913
3LG-2*	40X114	1	1743
3LG-3*	40X114	1	2719
3LG-4	40X114	38	3450
3LG-5*	40X114	1	3450

Wall B			
Mark	Profile	Count	Cut Length

BLG-1	40X114	18	800
BLG-2	40X114	9	3140
BLG-3	40X114	1	3390
BLG-4	40X114	1	3640
BLG-5	40X114	1	3890
BLG-6	40X114	1	4140
BLG-7	40X114	1	4140
BLG-8	40X114	15	4140
BTL-1	40X114	1	4240

Wall 2			
Mark	Profile	Count	Cut Length

2BL-1	40X57	1	555
2BL-2	40X57	1	2045
2LG-1	40X114	26	555
2LG-2	40X114	1	3450
2LG-3	40X114	9	715
2LG-4	40X114	8	2045
2LG-5	40X114	4	3450

\* Gable - delivered premounted

Wall A			
Mark	Profile	Count	Cut Length

ALG-1	40X114	18	3140
ALG-2	40X114	1	3390
ALG-3	40X114	1	3640
ALG-4	40X114	1	3890
ALG-5	40X114	1	4140
ALG-6	40X114	1	4140
ALG-7	40X114	15	4140
ATL-1	40X114	1	4240

Log profiles	
Profile	Profile

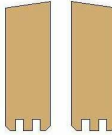
40X57	
40X114	

Log profiles	
Profile	Profile

40X114	
40X114	