

Kansas 40 (350x425)

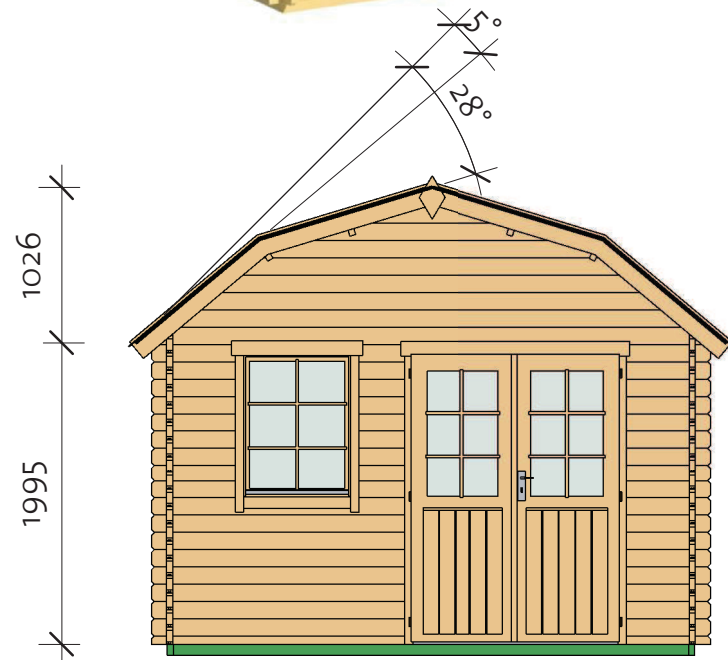

Kansas 40 (350x425)

Foundation

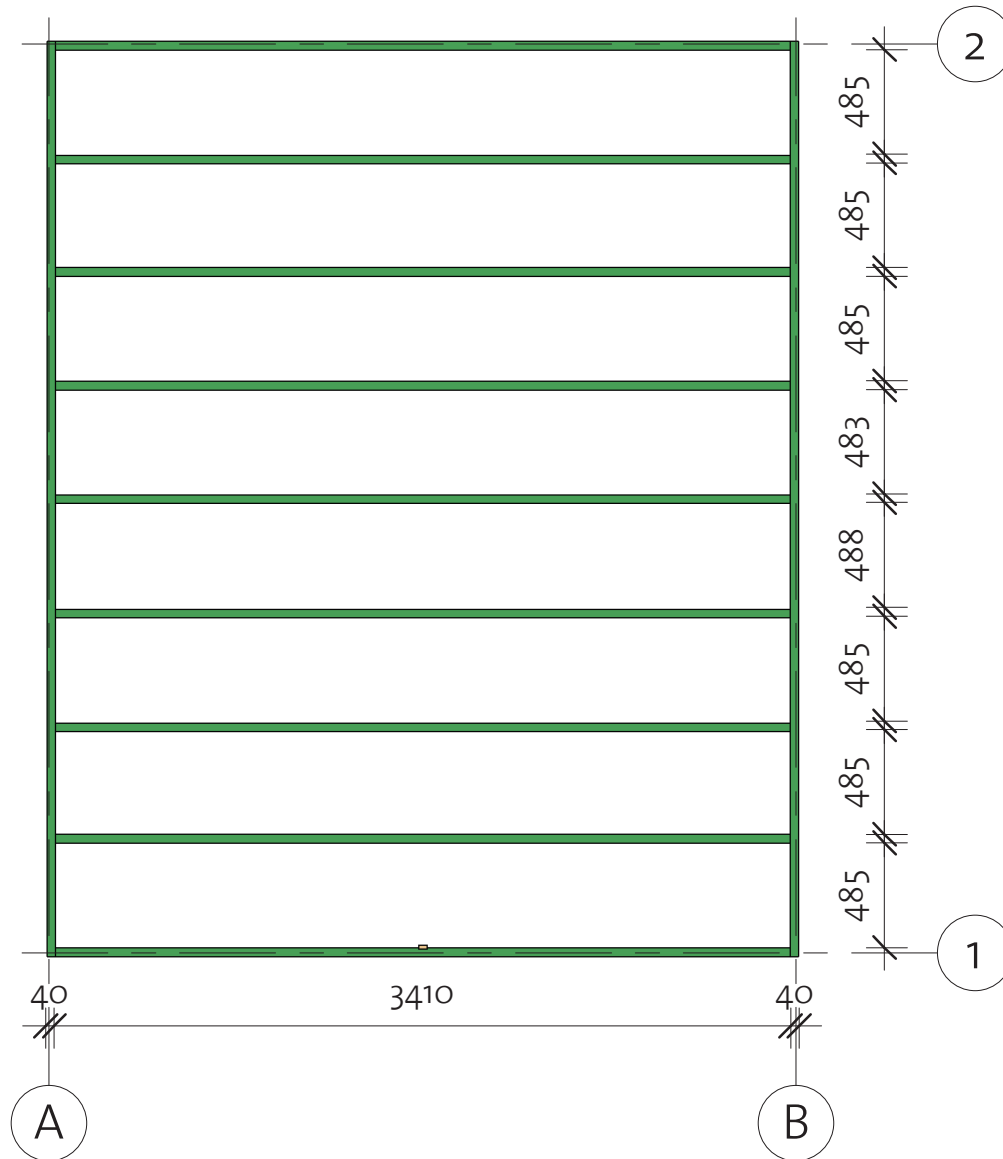

Impregnated foundation beams				
Mark	Type	Profile	Count	Length

IFB1	IFB 40x70		2	4240
IFB2	IFB 40x70		9	3410

Kansas 40 (350x425)

Floor Plan

① Baseboard

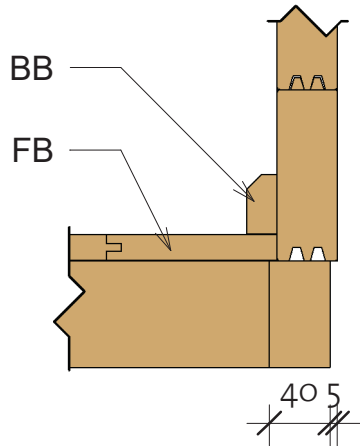

Floor Schedule

Mark	Type	Profile	Count	Length
FB	FB 17x114		31	4166
BB1	BB 20x40		2	4250
BB2	BB 20x40		2	3500

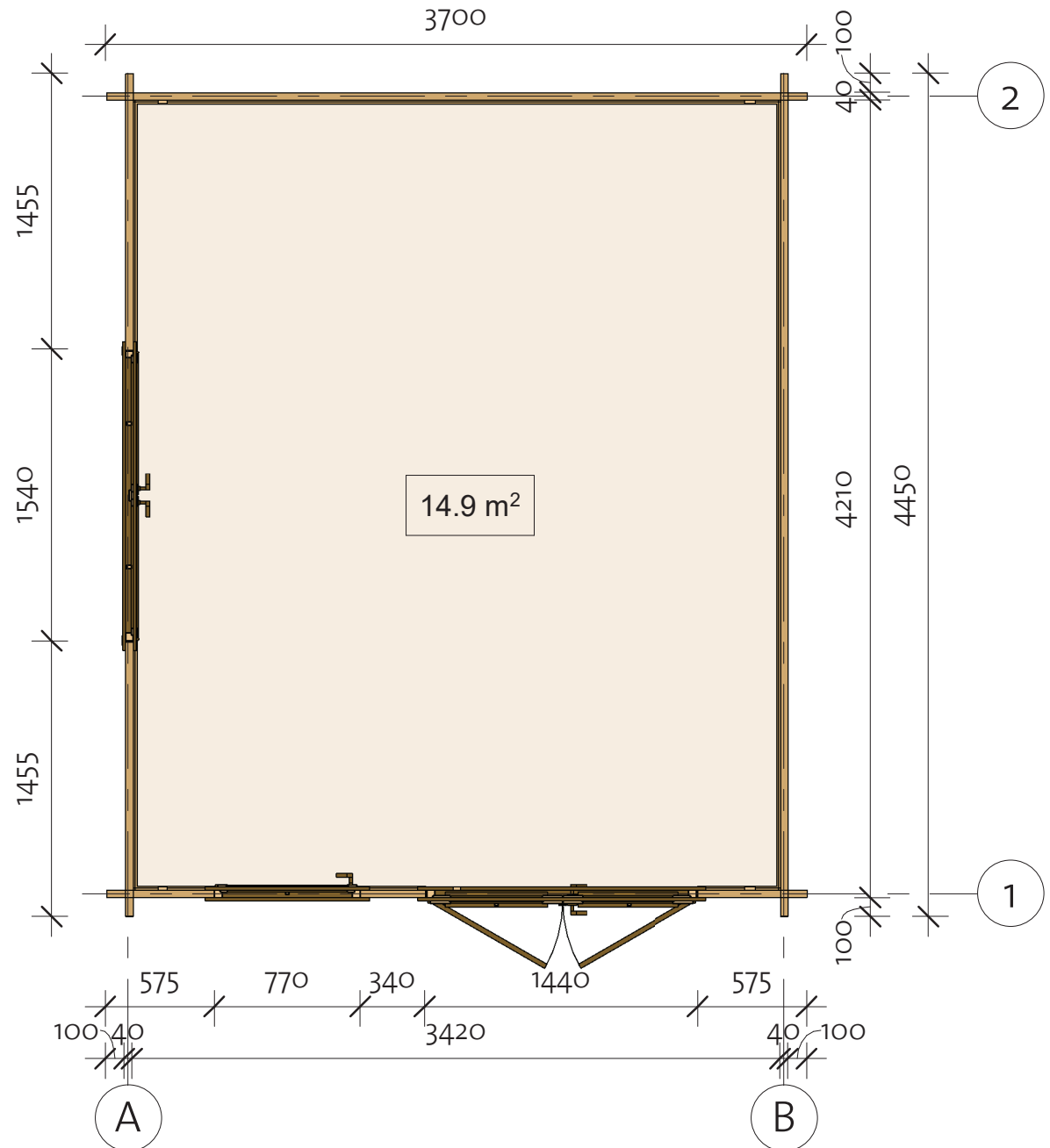

Kansas 40 (350x425)

Wall 1

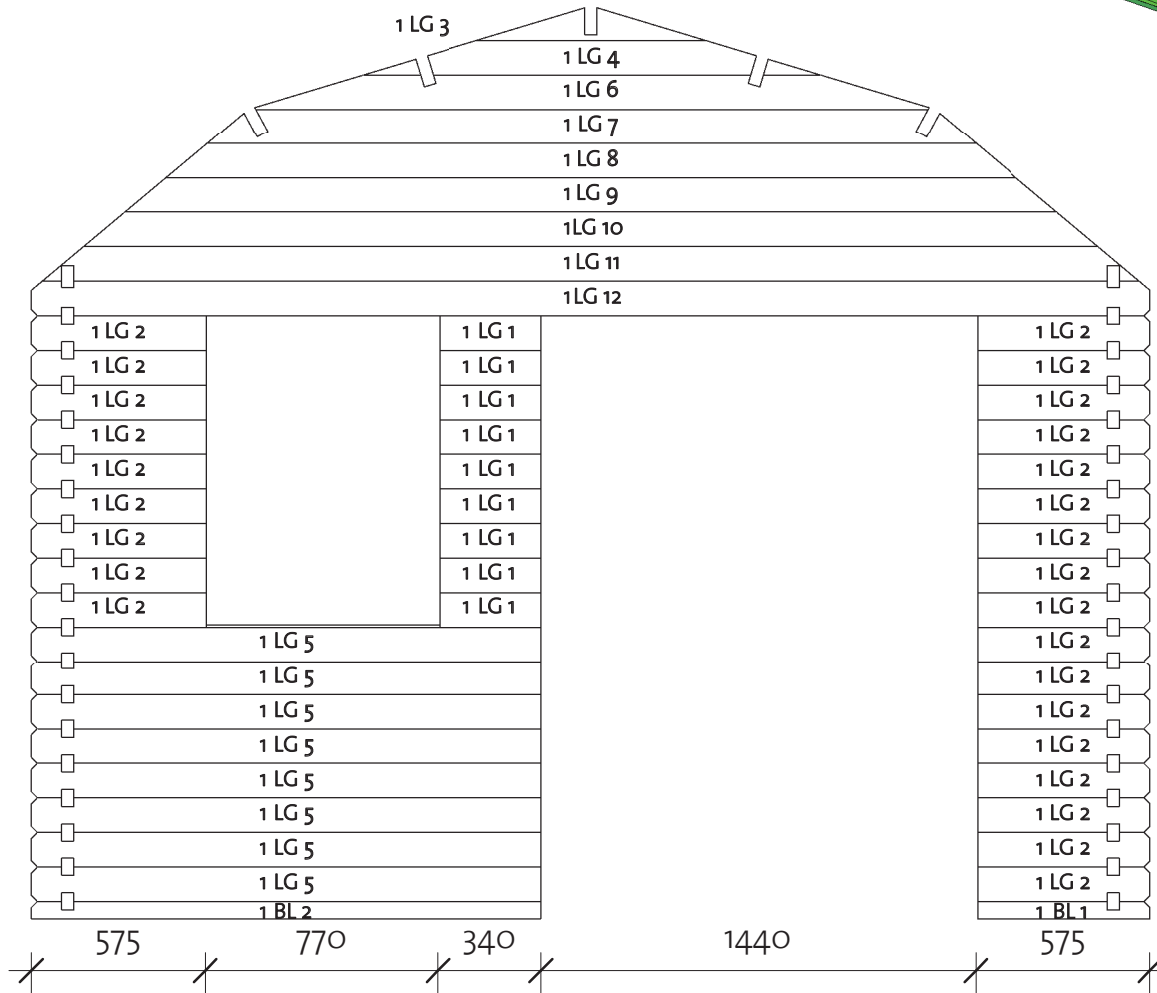
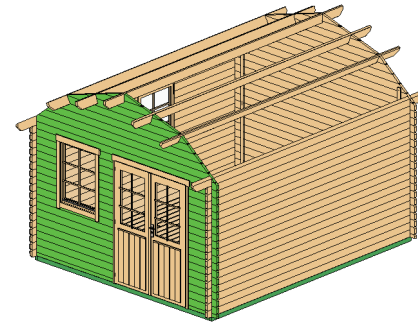



*Gable 1 - delivered premounted

**Gable 2 - delivered premounted

Wall 1			
Mark	Profile	Count	Cut Length

1BL 1	40X57	1	575
1BL 2	40X57	1	1685
1LG 1	40X114	9	340
1LG 2	40X114	26	575
1LG 3*	40X114	1	757
1LG 4*	40X114	1	1513
1LG 5	40X114	8	1685
1LG 6*	40X114	1	2230
1LG 7*	40X114	1	2541
1LG 8**	40X114	1	2813
1LG 9**	40X114	1	3085
1LG 10**	40X114	1	3357
1LG 11**	40X114	1	3629
1LG 12**	40X114	1	3700

Log Profile Wall 1	
Profile	Profile

40X57	
40X114	

Kansas 40 (350x425)

Wall 2

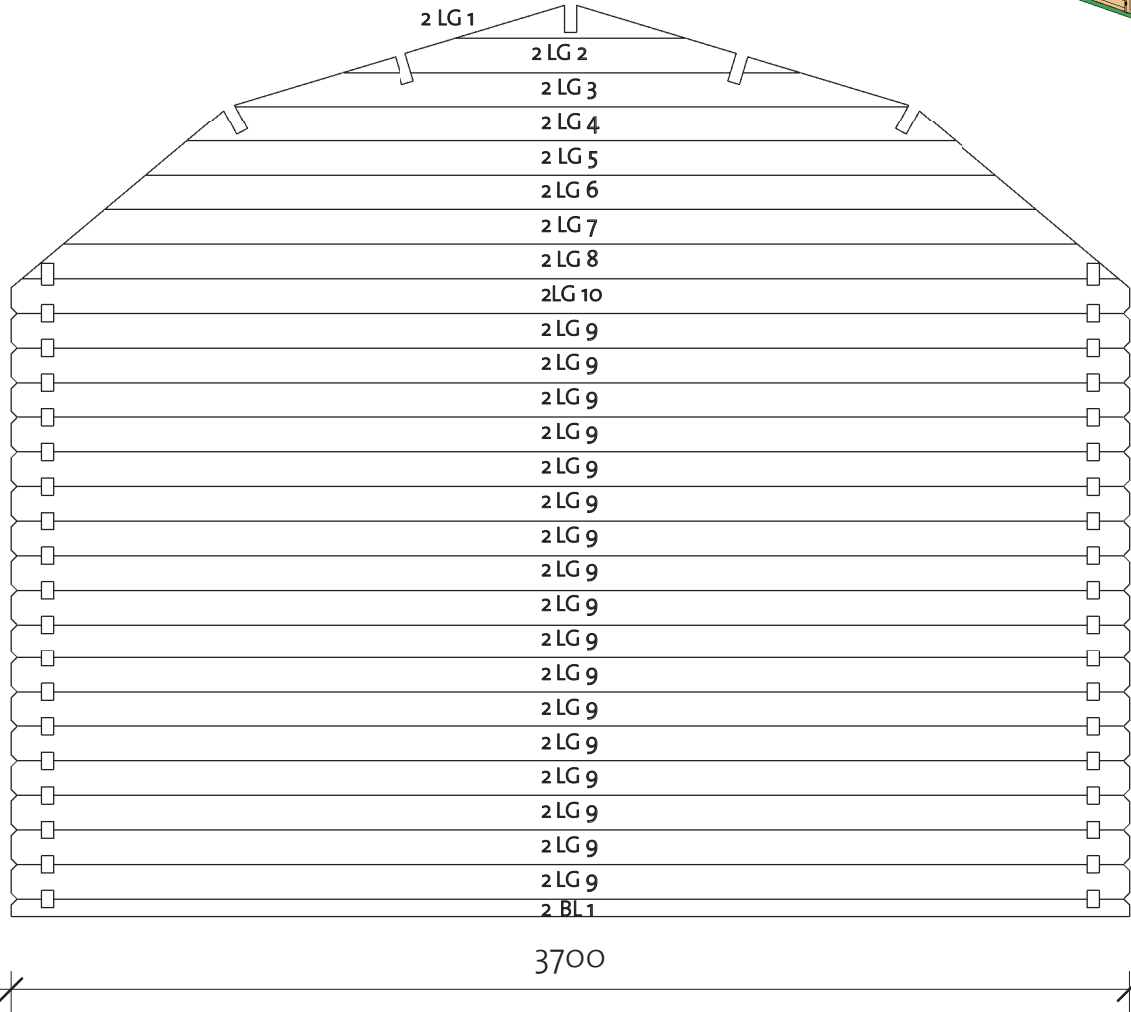
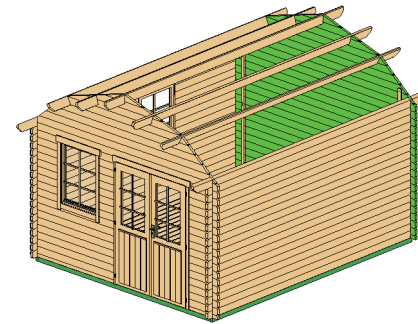

*Gable 1 - delivered premounted

**Gable 2 - delivered premounted

Wall 2			
Mark	Profile	Count	Cut Length

2BL 1	40X57	1	3700
2LG 1 *	40X114	1	757
2LG 2 *	40X114	1	1513
2LG 3 *	40X114	1	2230
2LG 4 *	40X114	1	2541
2LG 5 **	40X114	1	2813
2LG 6 **	40X114	1	3085
2LG 7 **	40X114	1	3357
2LG 8 **	40X114	1	3629
2LG 9	40X114	17	3700
2LG 10 **	40X114	1	3700

Log Profile Wall 2	
Profile	Profile

40X57	
40X114	

Kansas 40 (350x425)

Wall A

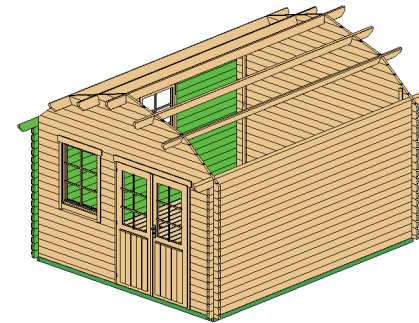

Wall A			
Mark	Profile	Count	Cut Length

ALG 1	40x114	18	1455
ALG 2	40x114	9	4450
ATL 1	40x145	1	5050

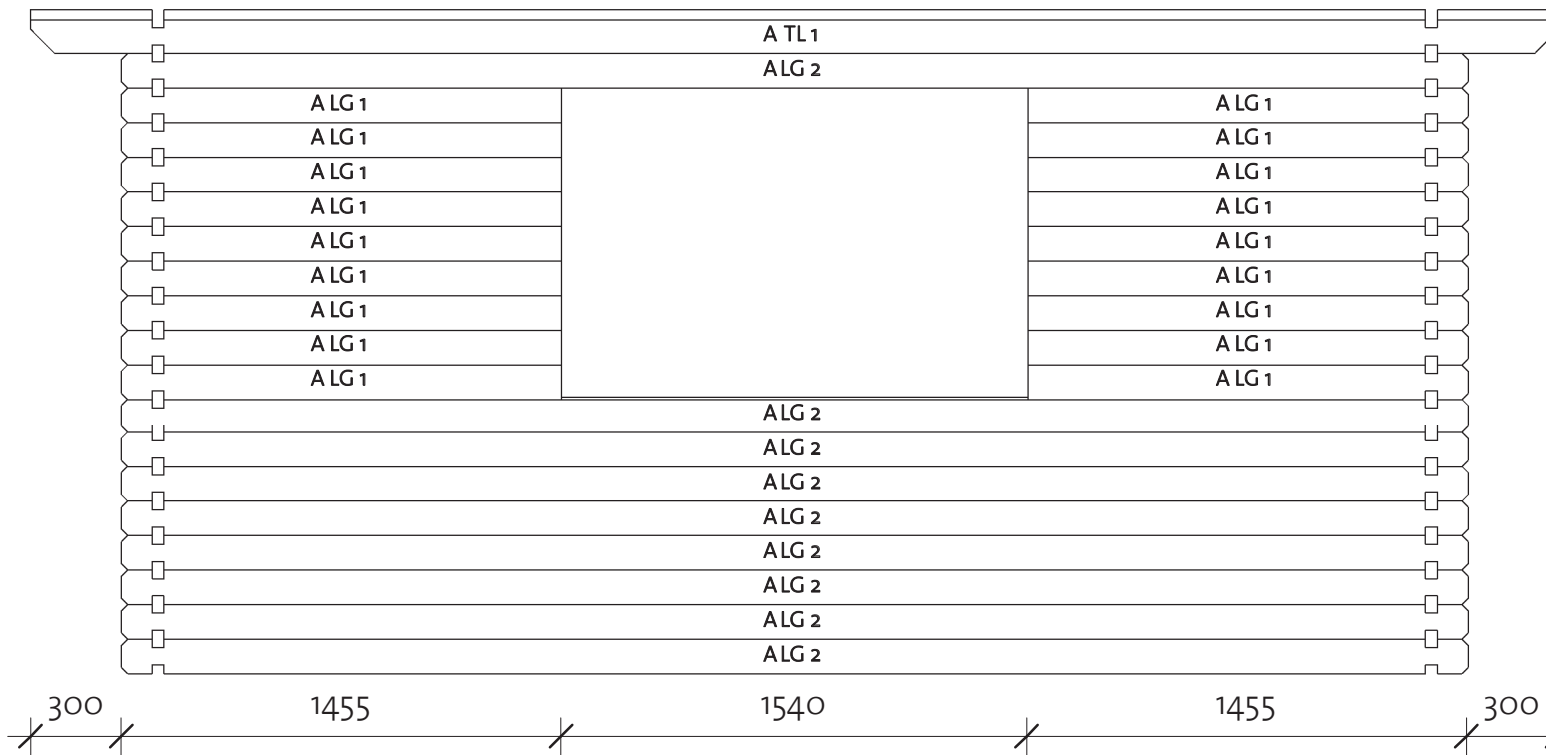

Log Profile Wall A	
Profile	Profile

40x114	
40x145	

Kansas 40 (350x425)

Wall B

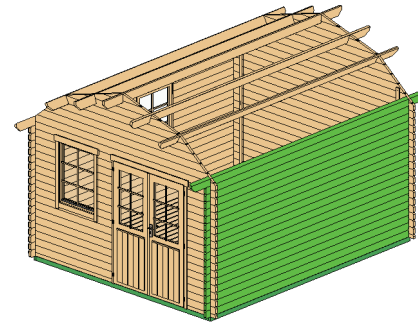

Wall B			
Mark	Profile	Count	Cut Length

BLG 1	40x114	18	4450
BTL 1	40x145	1	5050

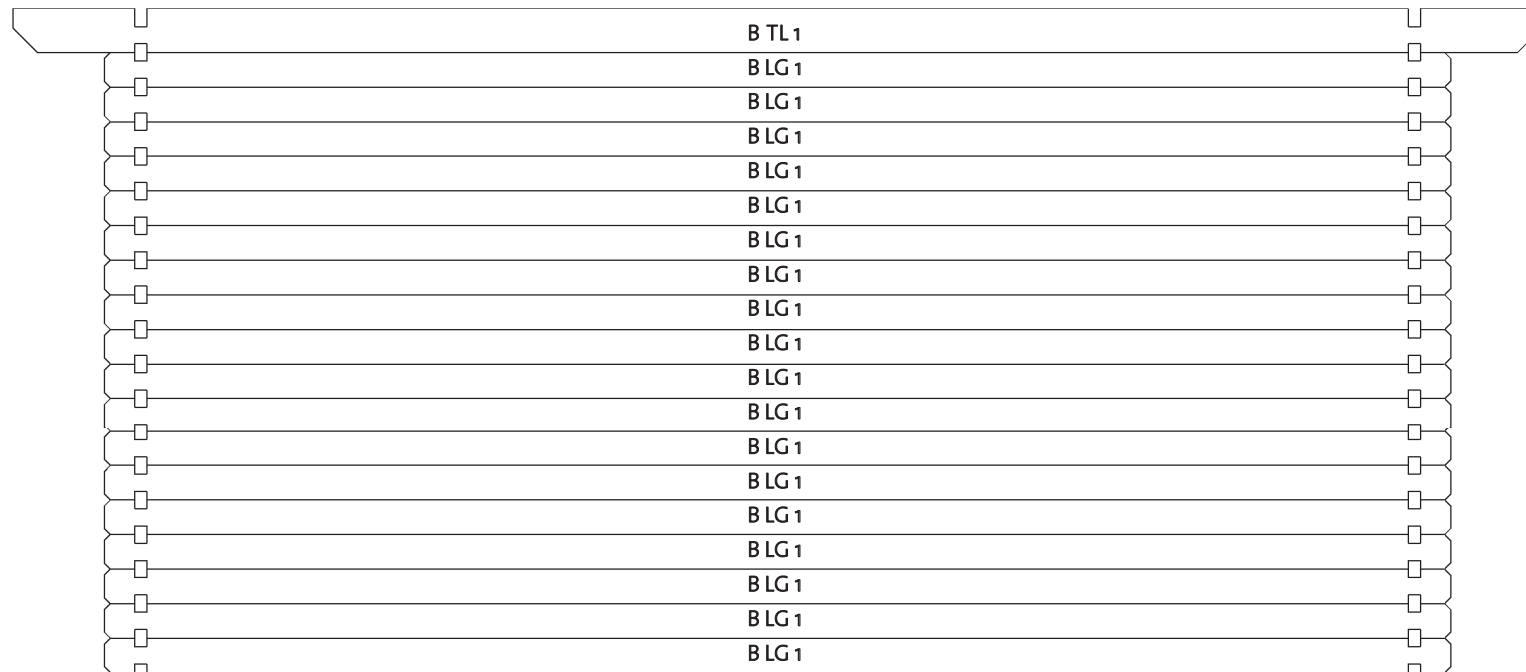





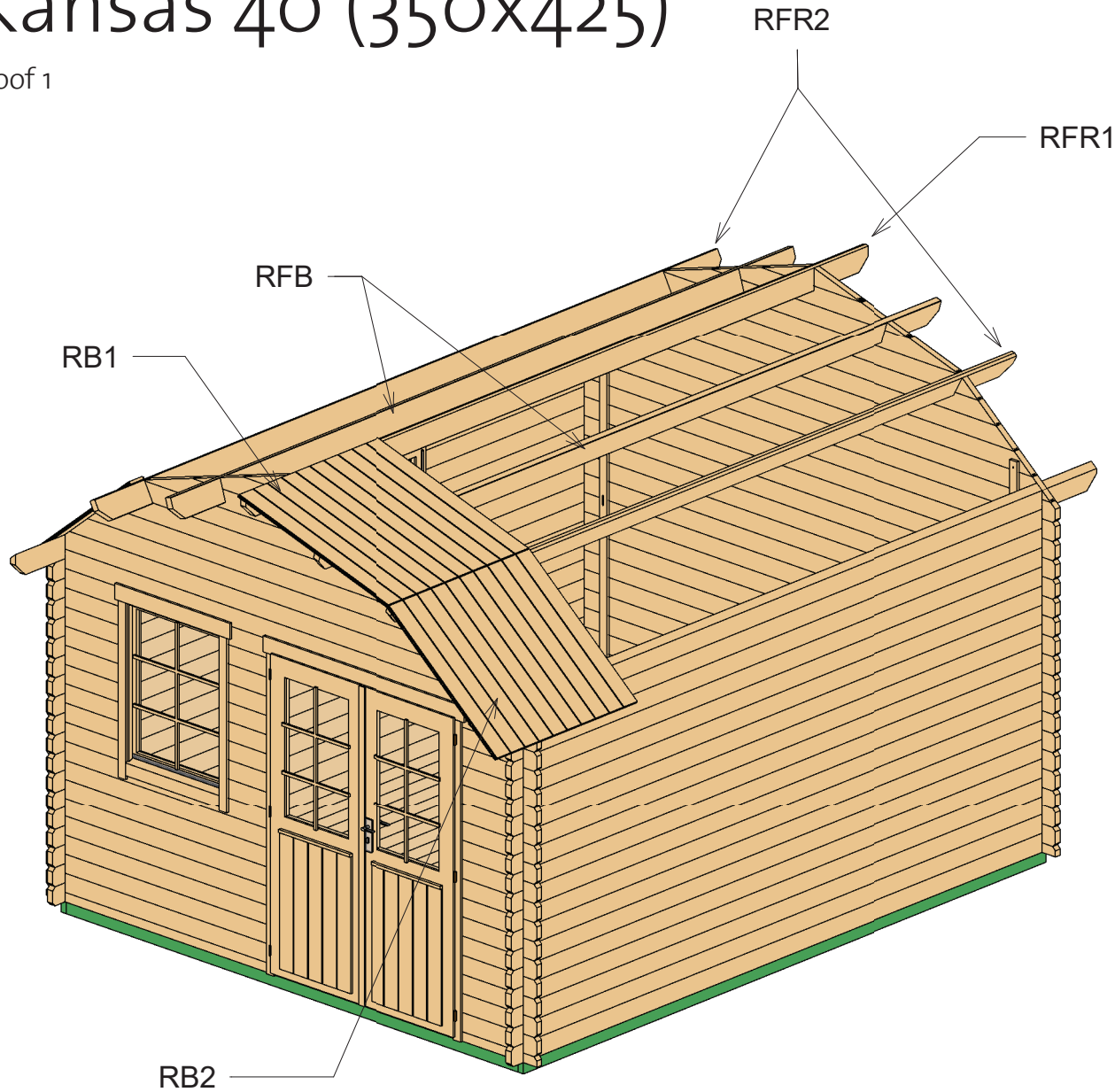

Log Profile Wall B	
Profile	Profile

40x114	
40x145	

Kansas 40 (350x425)

Roof 1



Roof				
Mark	Type	Profile	Count	Length
RFR1	Ridge 40x143		1	5050
RFR2	Ridge 40x143		2	5050
RFB	Beam 40x143		2	5050
RB1	17x114		92	1185
RB2	17x114		92	1060

Kansas 40 (350x425)

Roof 2

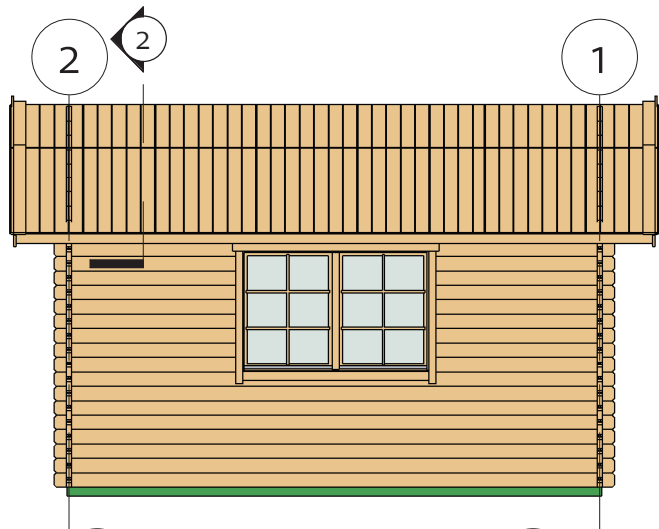

② Facia

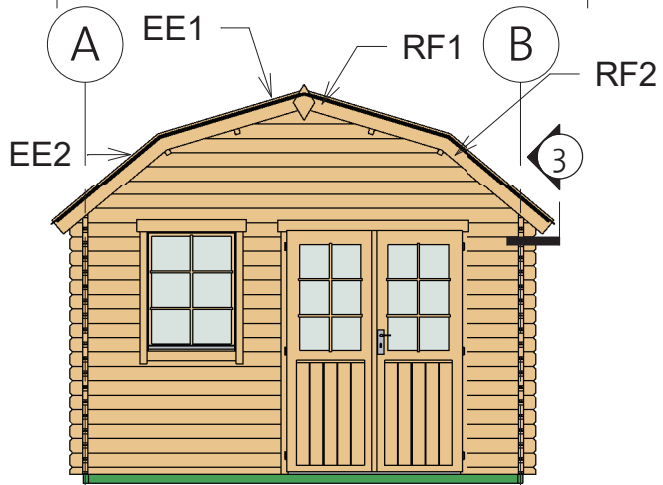
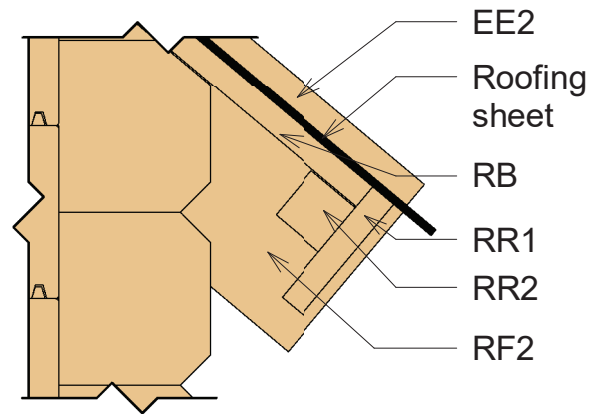



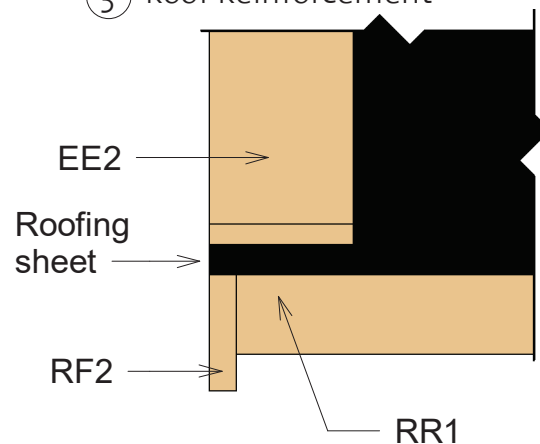





















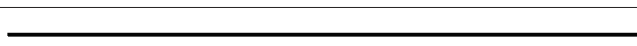





③ Roof Reinforcement



Fascia Schedule				
Mark	Type	Profile	Count	Length
EE1	Eave Edging 18x95		4	1197
EE2	Eave Edging 18x95		4	1090
RF1	Roof Fascia 18x120		4	1194
RF2	Roof Fascia 18x120		4	1090
RR1	Roof reinforcement 18x95		2	5050
RR2	Roof reinforcement 38x38		2	5050







Kansas 40 (350x425)

List of all items 1

	RFB	Beam 40x143			2	5050
	RFR1	Ridge 40x143			1	5050
	RFR2	Ridge 40x143			2	5050
A	TL 1	Log 40x145			1	5050
B	TL 1	Log 40x145			1	5050
B	LG 1	Log 40x114			18	4450
A	LG 2	Log 40x114			9	4450
	IFB1	IFB 40x70			2	4240
	FB	FB 17x114			31	4166
2	BL 1	Log 40x57			1	3700
2	LG 9	Log 40x114			17	3700
	IFB2	IFB 40x70			9	3410
1	BL 2	Log 40x57			1	1685
1	LG 5	Log 40x114			8	1685
A	LG 1				18	1455
	RB1	17x114			92	1185
	RB2	17x114			92	1060
1	BL 1	Log 40x57			1	575
1	LG 2				26	575
1	LG 1	Log 40x114			9	340

Kansas 40 (350x425)

List of all items 2

RR1	Roof reinforcement 18x95		2	5050
RR2	Roof reinforcement 38x38		2	5050
EE1	Eave Edging 18x95		4	1197
RF1	Roof Fascia 18x120		4	1194
EE2	Eave Edging 18x95		4	1090
RF2	Roof Fascia 18x120		4	1090

① Gable 1a

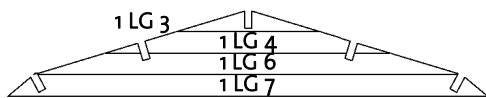

③ Gable 2a

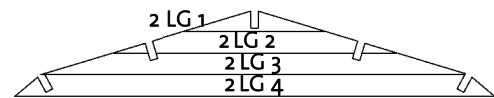

② Gable 1b





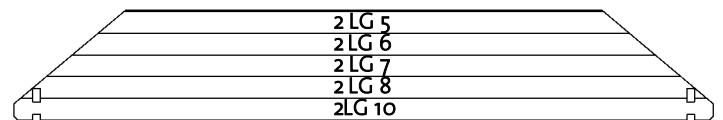



④ Gable 2b



BB1	BB 20x40			2	4250
BB2	BB 20x40			2	3500

Windboard 18x40		5	2200
-----------------	---	---	------

Romb	2	
------	---	---

Hitblock	300-400 mm		
Screws	5,0 x 70		15
Bolts	M8 x 70		16
Nails	1,4 x 40		30
Screws	6,0 x 140		70
Screws	4,0 x 40		970

CDD1R	Classic double door 1 right	1425	1955	1
-------	-----------------------------	------	------	---

DCB6	Door crossbar 6	--	--	2
------	-----------------	----	----	---

CDW1	Classic double window 1	1530	990	1
------	-------------------------	------	-----	---

CW1R	Classic window 1 right	765	990	1
------	------------------------	-----	-----	---

WCB6	Window crossbar 6	--	--	3
------	-------------------	----	----	---

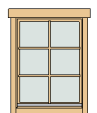
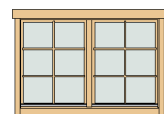
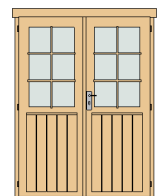

4200011_200206