

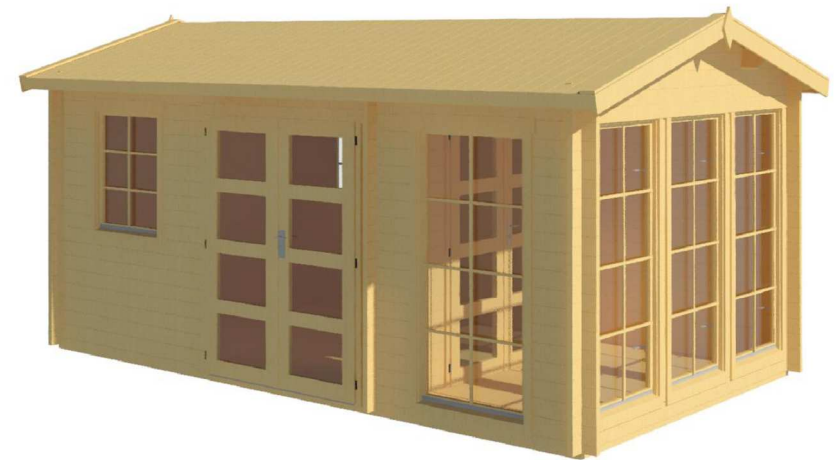

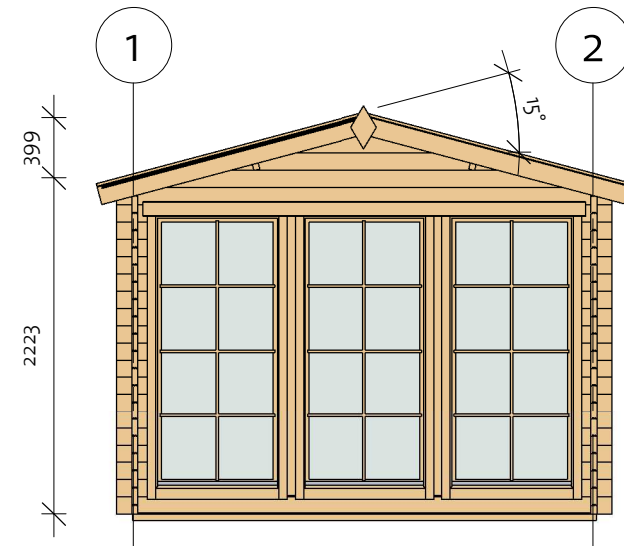

# Luna 160 40 (480x308)

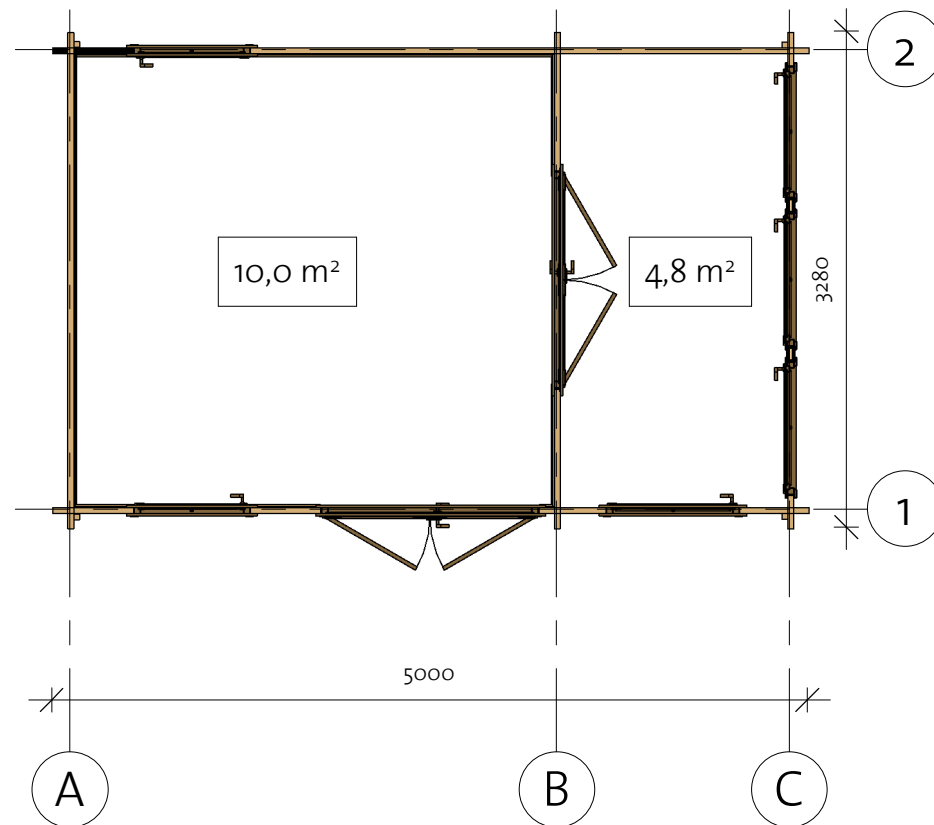
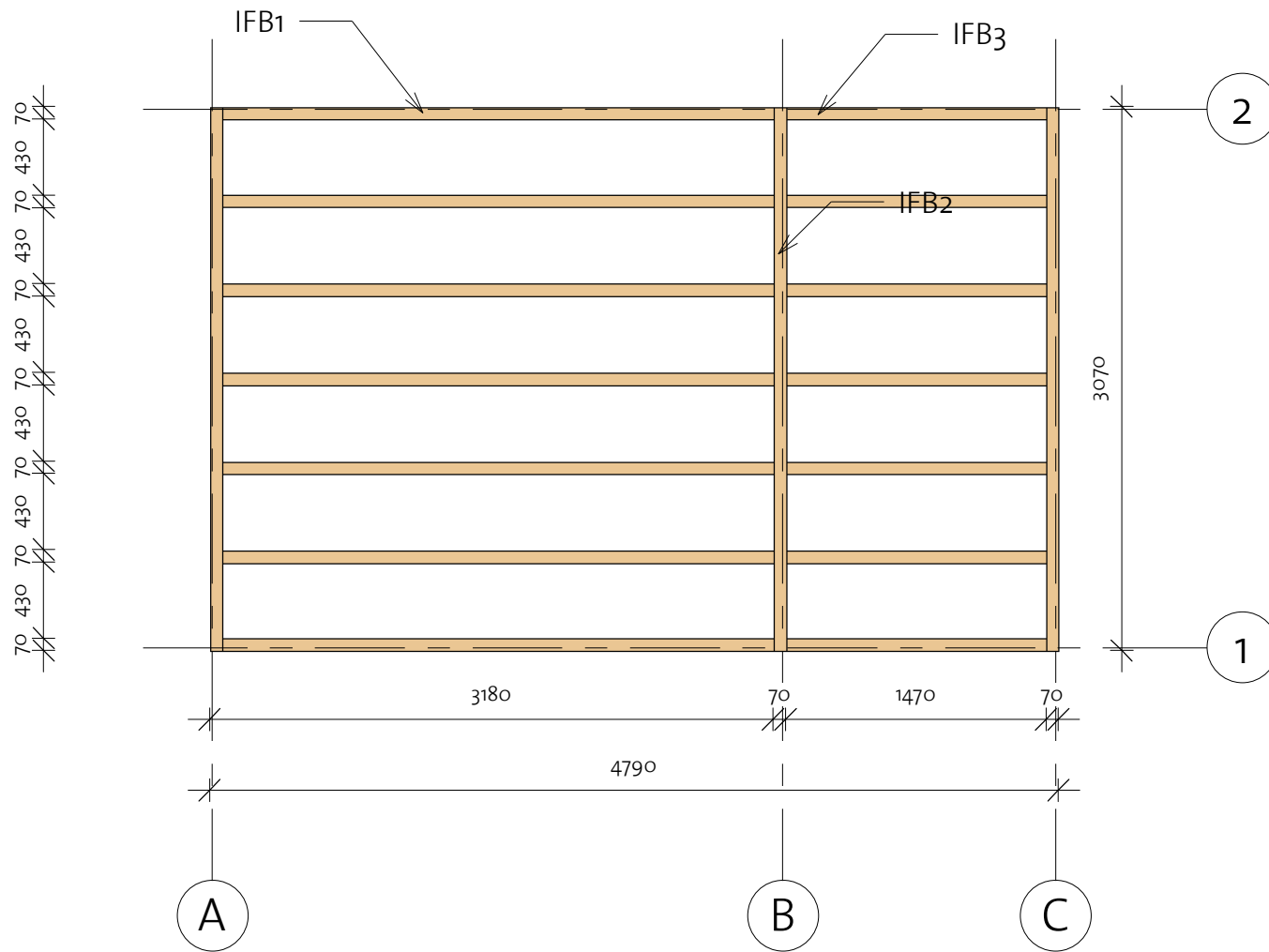

# Luna 160 40 (480x308)

Foundation



Impregnated foundation beams				
Mark	Type	Profile	Count	Length
IFB1	IFB 70x40		7	3110
IFB2	IFB 70x40		3	3070
IFB3	IFB 70x40		7	1470

# Luna 160 40 (480x308)

Floor Plan

① Baseboard

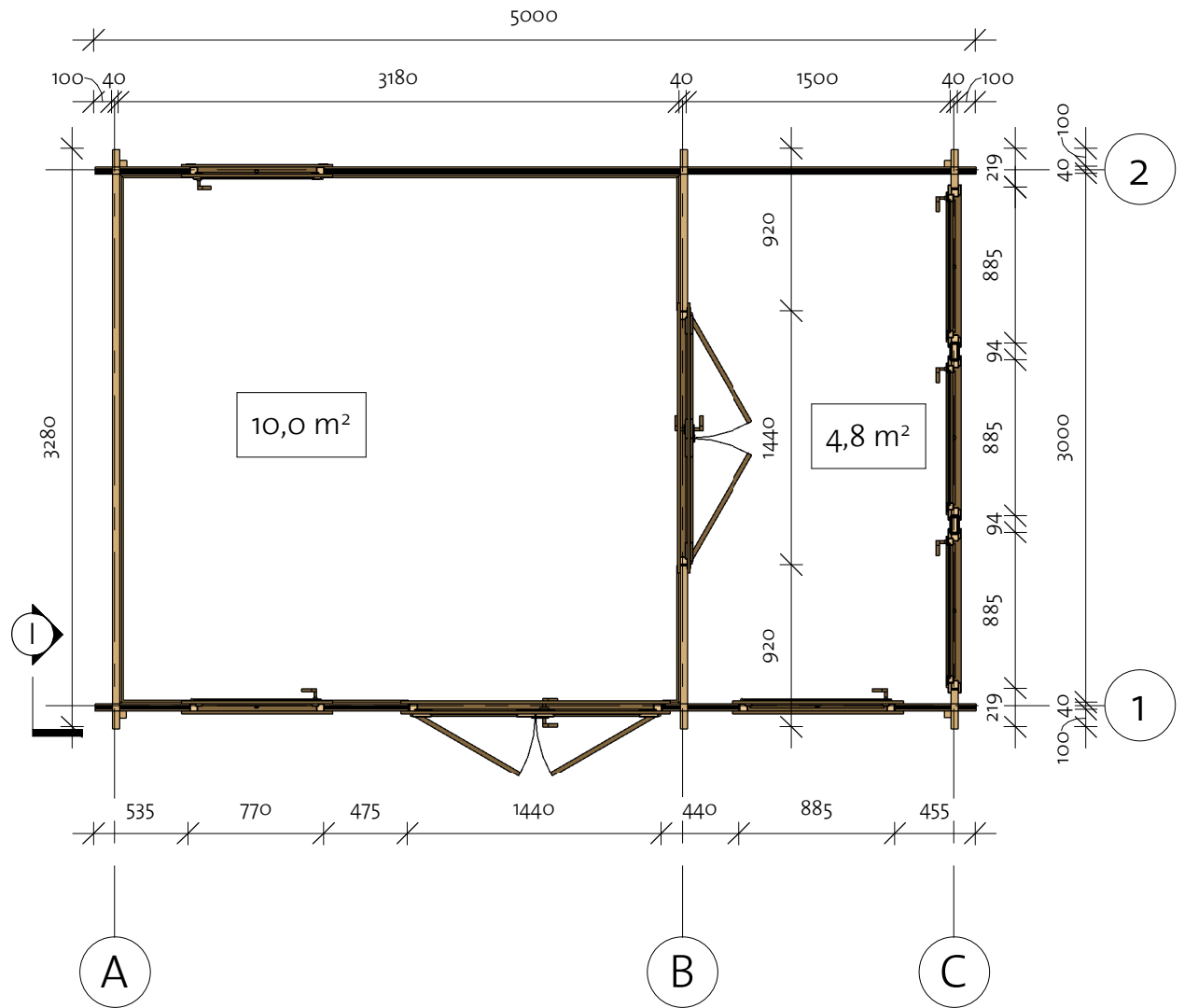
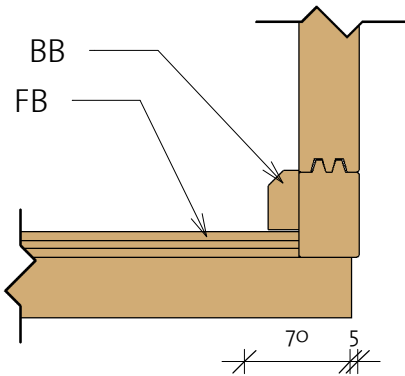

Floor Schedule

Mark	Type	Profile	Count	Length
------	------	---------	-------	--------

FB	FB 17x114		43	2997
----	-----------	--	----	------

BB1	BB 20x40		3	3300
BB2	BB 20x40		4	3100

92304271\_230721

# Luna 160 40 (480x308)

Wall 1

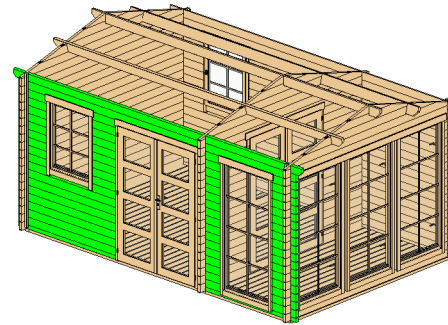

Wall 1			
Mark	Profile	Count	Cut Length

1BL-1	40X57	1	1780
1BL-2	40X57	1	1780
1LG-1	40X114	9	475
1LG-2	40X114	9	535
1LG-3	40X114	17	440
1LG-4	40X114	17	455
1LG-5	40X114	1	5000
1LG-6	40X114	8	1780
1TL-1	40X114	1	5200

Log Profile Wall 1	
Profile	Profile

40X114	
--------	--

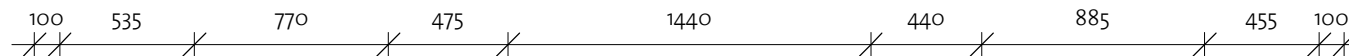
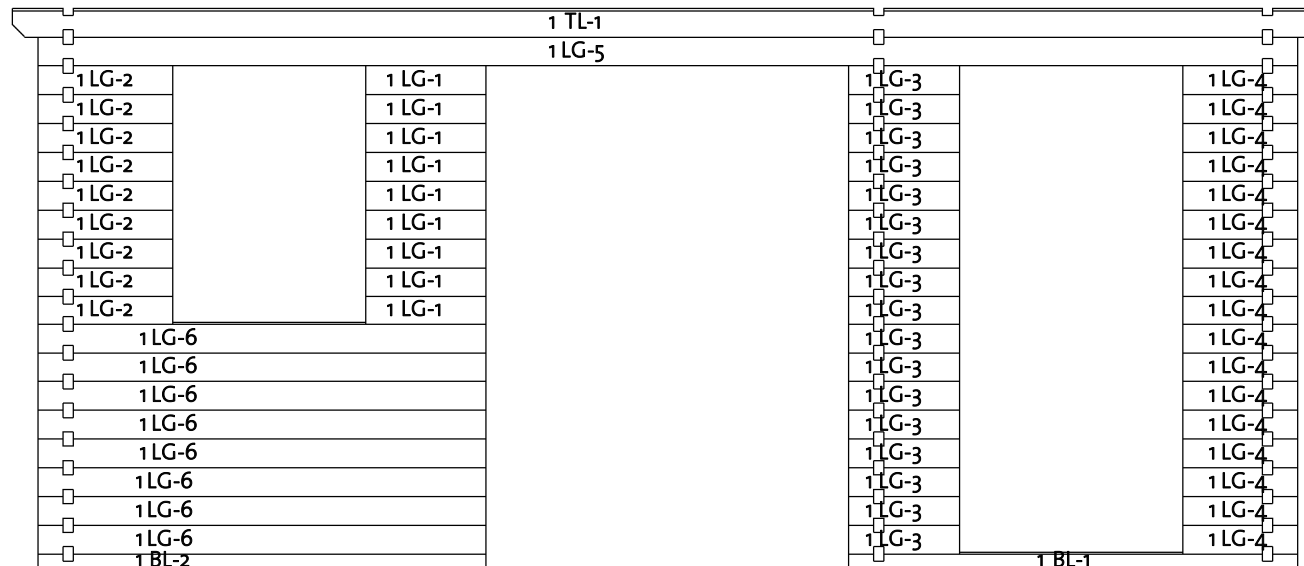

Log Profile Wall 1	
Profile	Profile

40X57	
40X114	

# Luna 160 40 (480x308)

Wall 2

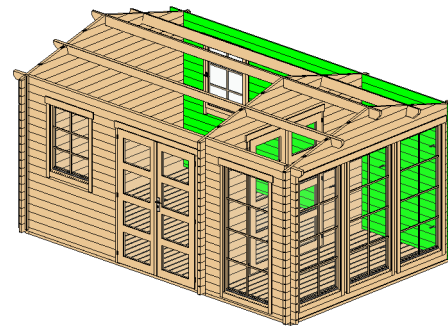

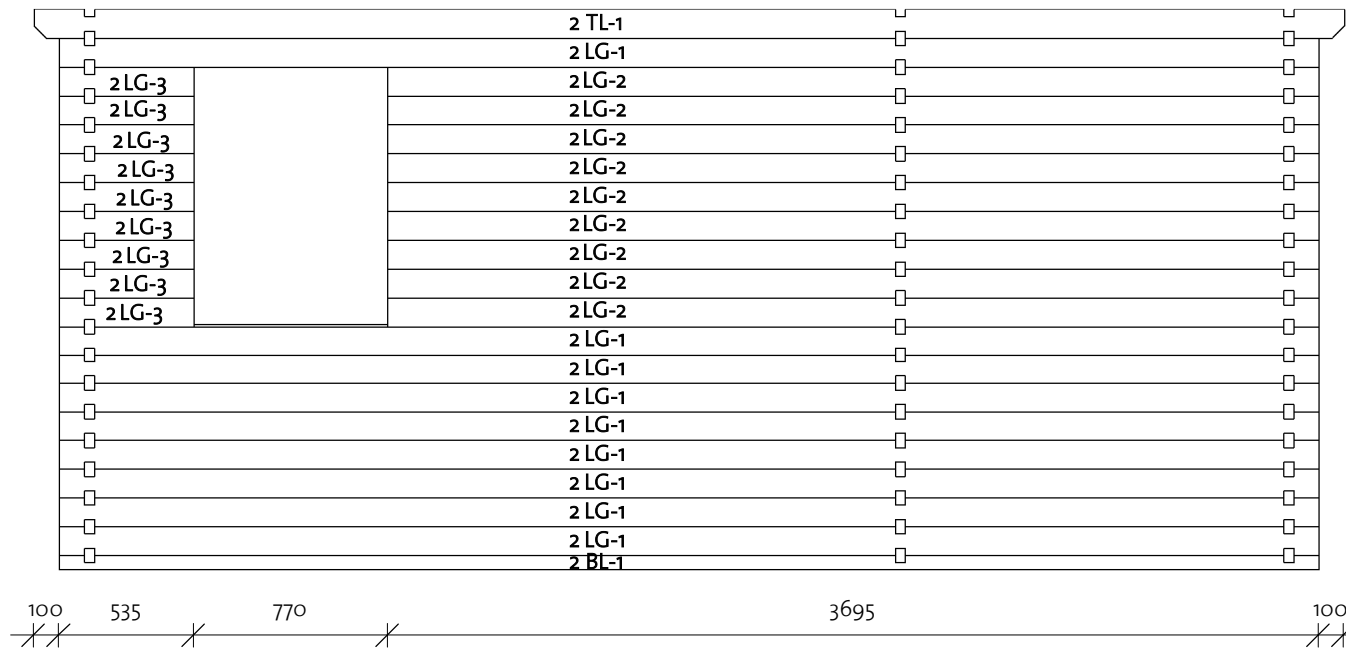

Wall 2			
Mark	Profile	Count	Cut Length

2BL-1	40x57	1	5000
2LG-1	40x114	9	5000
2LG-2	40x114	9	3695
2LG-3	40x114	9	535
2TL-1	40x114	1	5200



Log Profile Wall 2	
Profile	Profile

40x57	
40x114	
40x114	

# Luna 160 40 (480x308)

Wall A

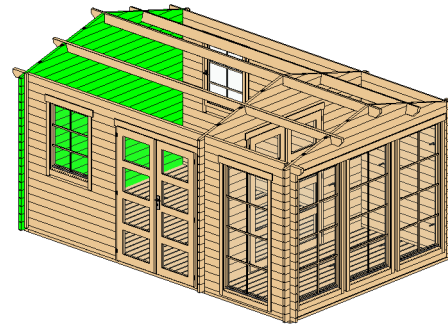

Wall A			
Mark	Profile	Count	Cut Length

ALG-1*	40x114	1	858
ALG-2*	40x114	1	1715
ALG-3*	40x114	1	2572
ALG-4	40x114	19	3280
ALG-5*	40x114	1	3280

\*Gable-delivered premounted

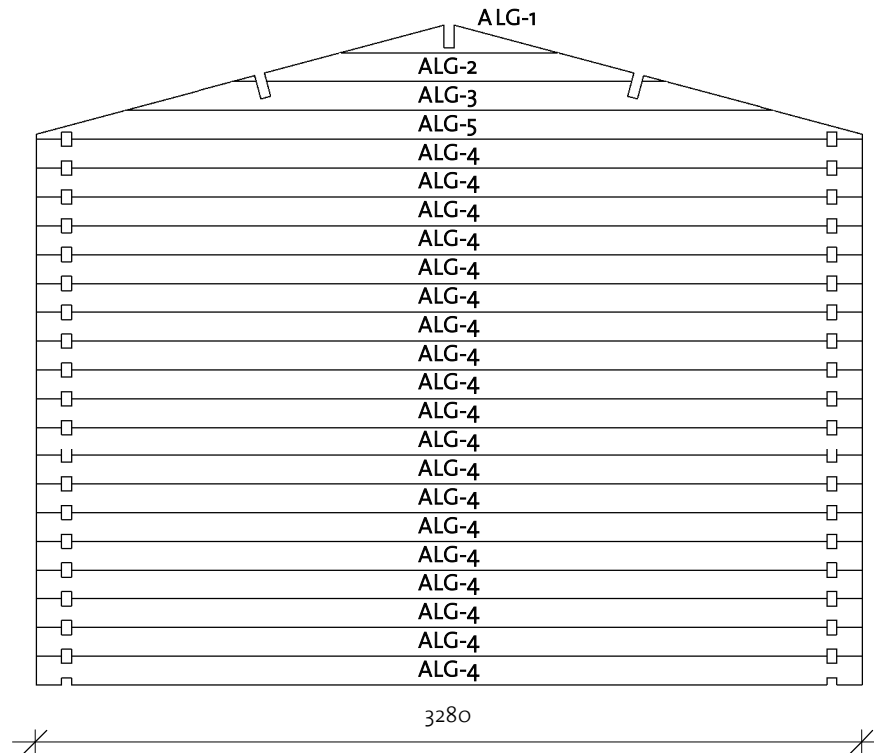

Log Profile Wall A	
Profile	Profile

40x114	
--------	--

# Luna 160 40 (480x308)

Wall B

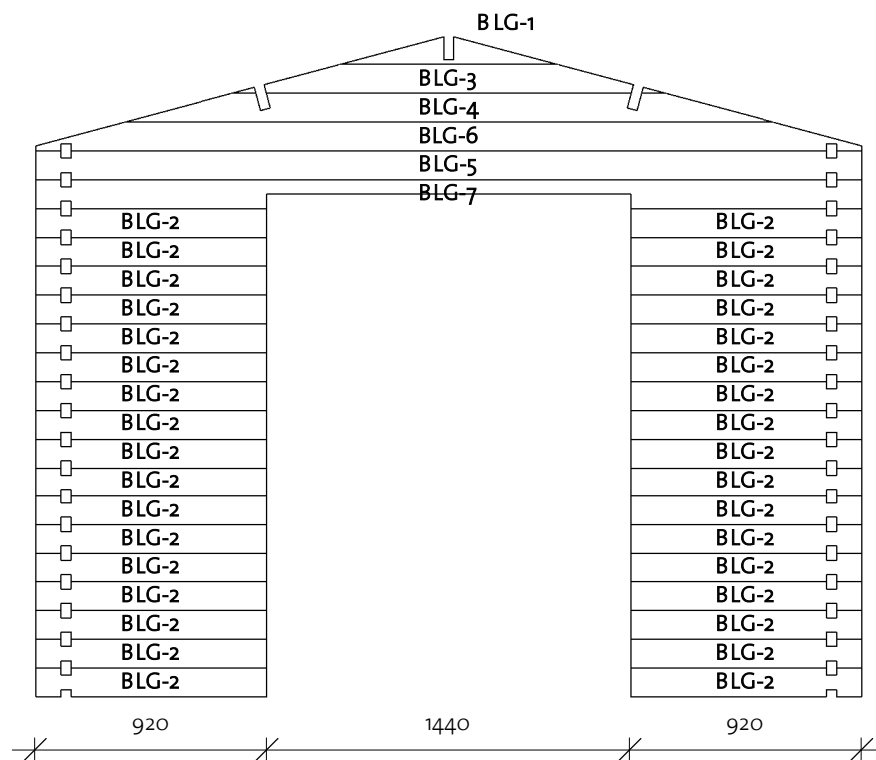
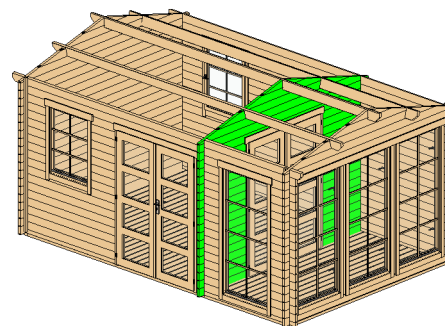

Wall B			
Mark	Profile	Count	Cut Length

BLG-1*	40x114	1	858
BLG-2	40x114	34	920
BLG-3*	40x114	1	1715
BLG-4*	40x114	1	2572
BLG-5	40x114	1	3280
BLG-6*	40x114	1	3280
BLG-7	40x114	1	3280

\*Gable-delivered premounted

Log Profile Wall B	
Profile	Profile

40x114	
--------	--

# Luna 160 40 (480x308)

Wall C

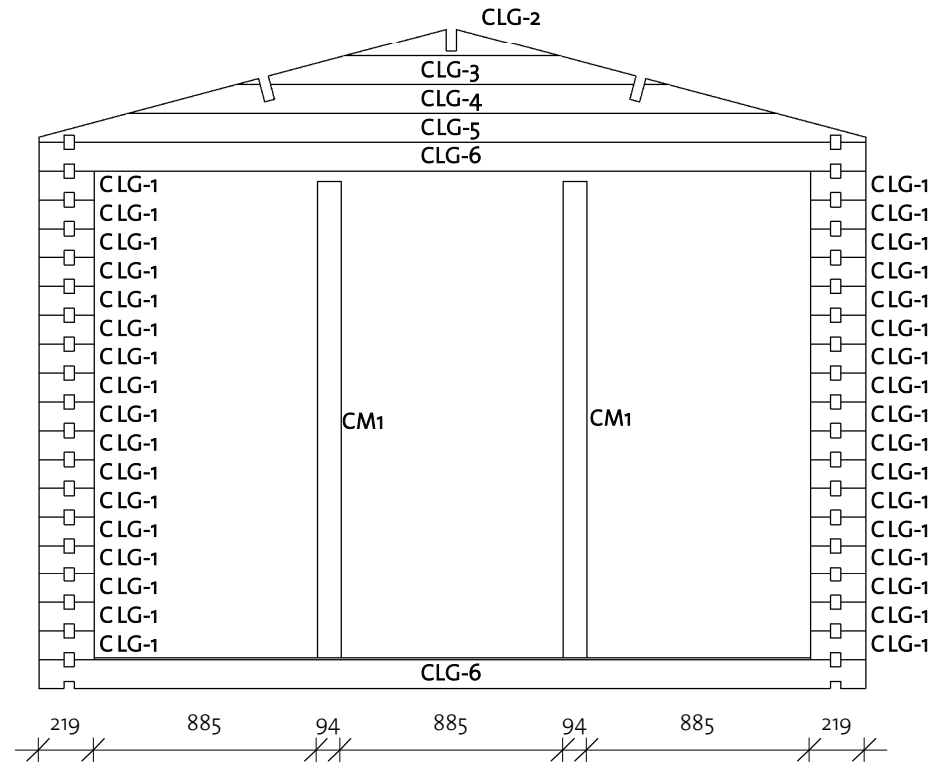
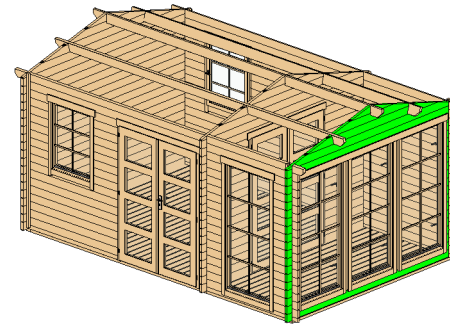

Wall C			
Mark	Profile	Count	Cut Length

CLG-1	40x114	34	219
CLG-2*	40x114	1	858
CLG-3*	40x114	1	1715
CLG-4*	40x114	1	2572
CLG-5*	40x114	1	3280
CLG-6	40x114	2	3280

\*Gable-delivered premounted

Log Profile Wall C	
Profile	Profile

Columns			
Mark	Profile	Count	Length

CM1	Post 40x94	2	1890
-----	------------	---	------

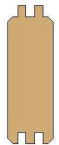

40x114	
--------	---

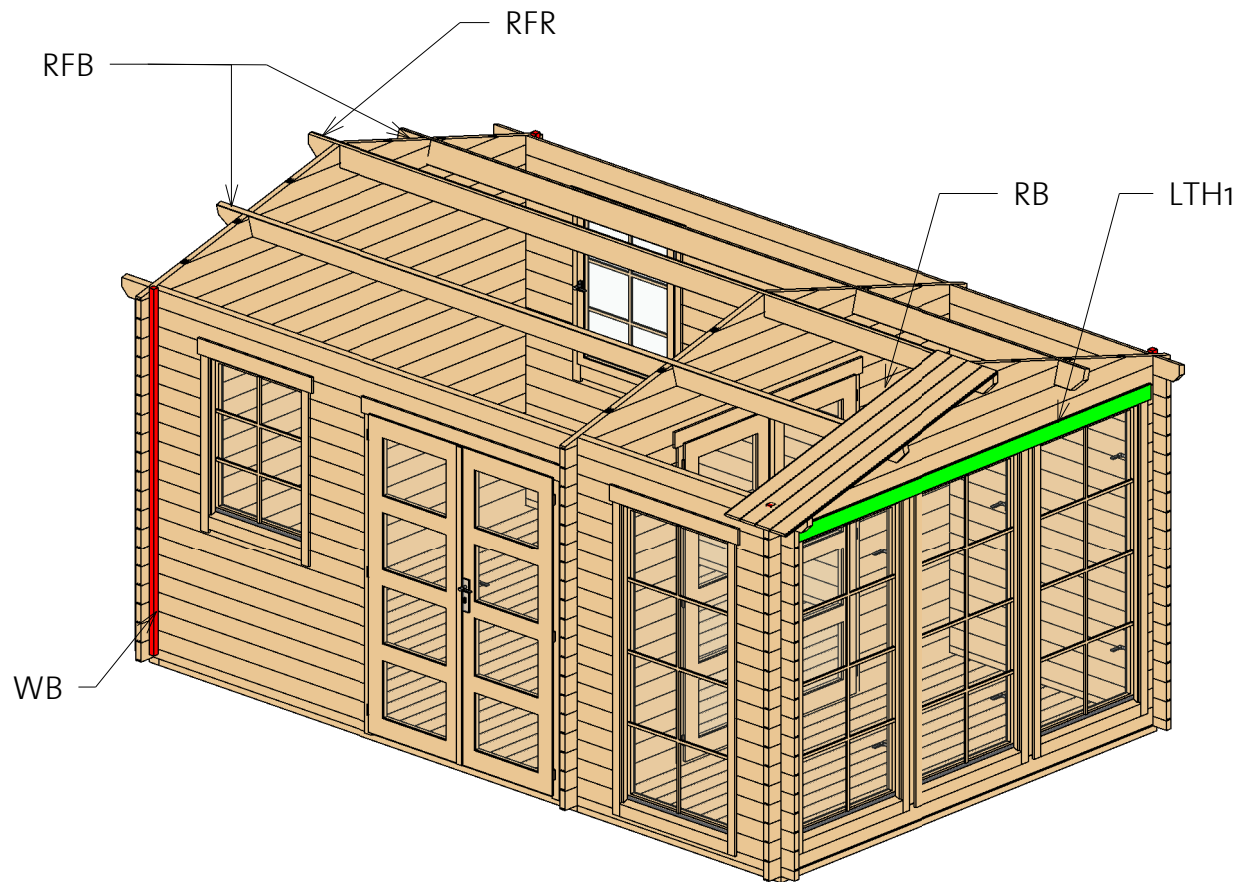

# Luna 160 40 (480x308)

Roof 1



Roof				
Mark	Type	Profile	Count	Length
RFR	Ridge 40x143		1	5200
RFB	Beam 40x143		2	5200
RB	17x114		94	1796

Lath list				
Mark	Type	Profile	Count	Length
LTH1	18x95		2	2930

# Luna 160 40 (480x308)

Roof 2

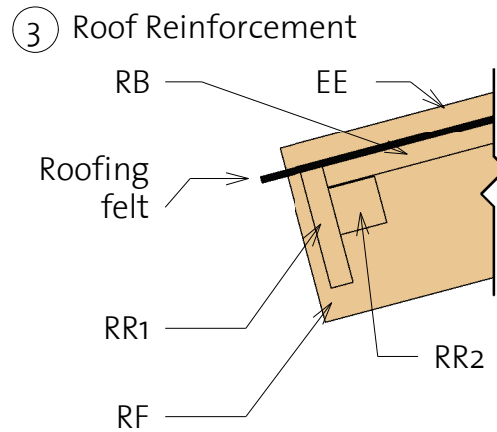
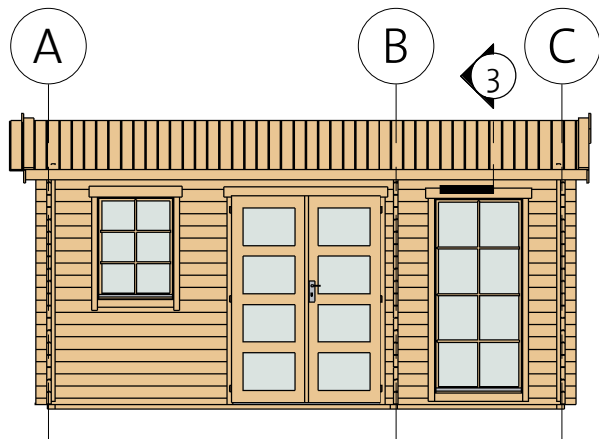
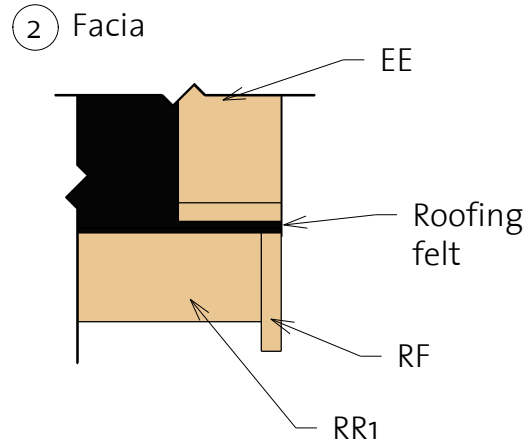
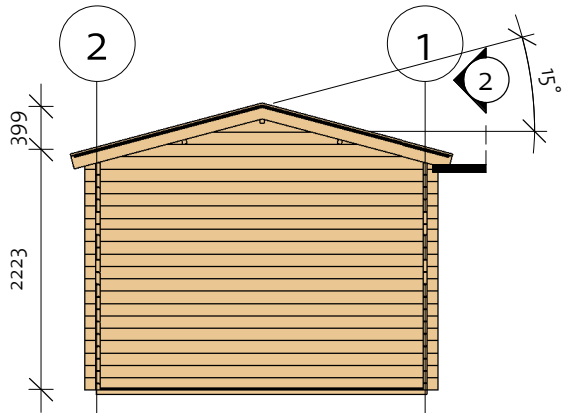

Fascia Schedule				
Mark	Type	Profile	Count	Length
EE	Eave Edging 18x95		4	1830
RF	Roof Fascia 18x120		4	1830
RR1	Roof reinforcement 18x95		2	5200
RR2	Roof reinforcement 38x38		2	5200

# Luna 160 40 (480x308)

Extras

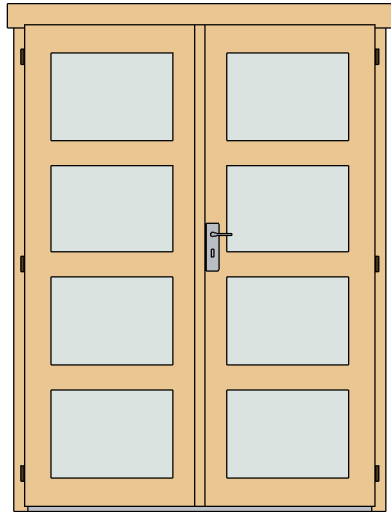

Door Schedule				
Mark	Type	Width	Height	Count
CDD2R	Classic double door 2, four glass right	1425	1955	2

Fasteners & Extras		
Name	Type	Count

Hitblock	300-400 mm	
Screws	5,0 x 70	20
Bolts	M8 x 90	20
Nails	1,4 x 40	45
Screws	6,0 x 140	75
Screws	4,0 x 40	750

Family	Count
Romb	2

◆

Windboard		
Type	Count	Length
Windboard 38x38	4	2200

- \* Windows intended for tilt opening only!
- \* Fenster zur Eröffnung nur zum Kippen vorgesehen!
- \* Aknad on ette nähtud ainult kaldu avamiseks!

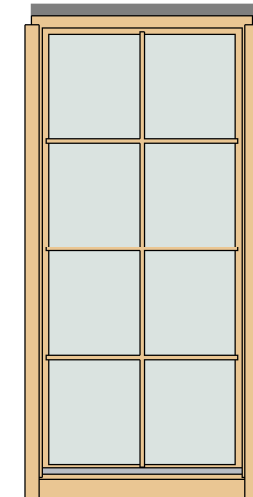
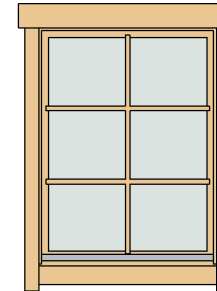



Window Schedule				
Mark	Type	Width	Height	Count
CW1R	Classic window 1 right	765	990	2
CW4R	Classic window 4 right	875	1890	1
CW4R	Classic window 4 right	875	1890	3

WCB10	Windows Crossbar 10	--	--	2
WCB8.2	Windows Crossbar 8.2	--	--	4



# Luna 160 40 (480x308)

## List of all items 1



### Impregnated foundation beams

Mark	Type	Profile	Count	Length
IFB1	IFB 70x40		7	3110
IFB2	IFB 70x40		3	3070
IFB3	IFB 70x40		7	1470





### Floor Schedule

Mark	Type	Profile	Count	Length
FB	FB 17x114		43	2997
BB1	BB 20x40		3	3300
BB2	BB 20x40		4	3100

### Roof

Mark	Type	Profile	Count	Length
RFR	Ridge 40x143		1	5200
RFB	Beam 40x143		2	5200
RB	17x114		94	1796

### Fascia Schedule

Mark	Type	Profile	Count	Length
EE	Eave Edging 18x95		4	1830
RF	Roof Fascia 18x120		4	1830
RR1	Roof reinforcement 18x95		2	5200
RR2	Roof reinforcement 38x38		2	5200

# Luna 160 40 (480x308)

## List of all items 2

Wall 1			
Mark	Profile	Count	Cut Length

1BL-1	40x57	1	1780
1BL-2	40x57	1	1780
1LG-1	40x114	9	475
1LG-2	40x114	9	535
1LG-3	40x114	17	440
1LG-4	40x114	17	455
1LG-5	40x114	1	5000
1LG-6	40x114	8	1780
1TL-1	40x114	1	5200

Wall 2			
Mark	Profile	Count	Cut Length

2BL-1	40x57	1	5000
2LG-1	40x114	9	5000
2LG-2	40x114	9	3695
2LG-3	40x114	9	535
2TL-1	40x114	1	5200



Lath list				
Mark	Type	Profile	Count	Length

LTH1	18x95		2	2930
------	-------	---	---	------

Columns			
Mark	Profile	Count	Length

CM1	Post 40x94	2	1890
-----	------------	---	------

Log Profiles1	
Profile	Profile

40x57	
40x114	

Log Profiles1	
Profile	Profile

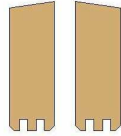
40x114	
--------	---

# Luna 160 40 (480x308)

## List of all items 3

Wall A			
Mark	Profile	Count	Cut Length

ALG-1*	40X114	1	858
ALG-2*	40X114	1	1715
ALG-3*	40X114	1	2572
ALG-4	40X114	19	3280
ALG-5*	40X114	1	3280

Wall C			
Mark	Profile	Count	Cut Length

CLG-1	40X114	34	219
CLG-2*	40X114	1	858
CLG-3*	40X114	1	1715
CLG-4*	40X114	1	2572
CLG-5*	40X114	1	3280
CLG-6	40X114	2	3280

Log Profiles2	
Profile	Profile

40X114	
--------	---

Wall B			
Mark	Profile	Count	Cut Length

BLG-1*	40X114	1	858
BLG-2	40X114	34	920
BLG-3*	40X114	1	1715
BLG-4*	40X114	1	2572
BLG-5	40X114	1	3280
BLG-6*	40X114	1	3280
BLG-7	40X114	1	3280

\*Gable-delivered premounted

# Windboard

① Windboard Assembly 1



② Windboard Assembly 2

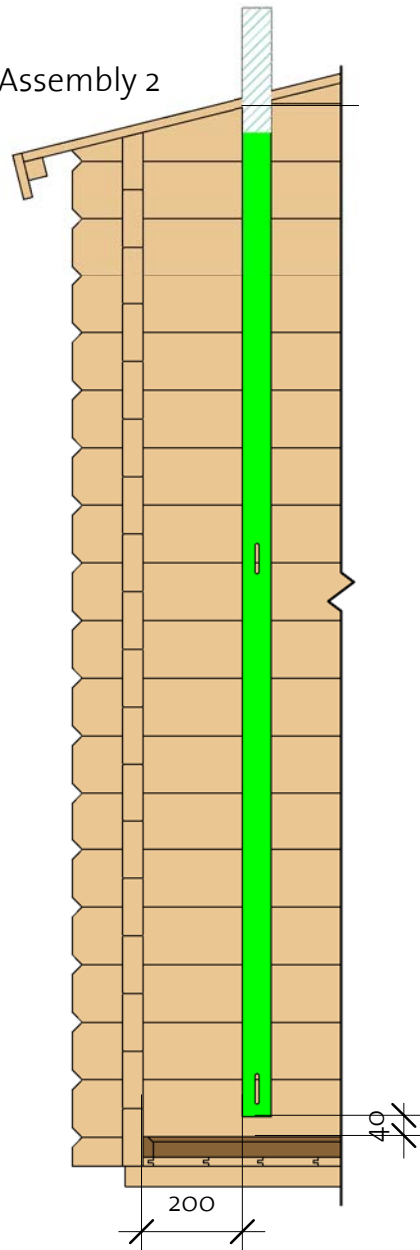

③ Windboard Assembly 3

