

# Mason Mini 40 (118 1/8" x 86 5/8")

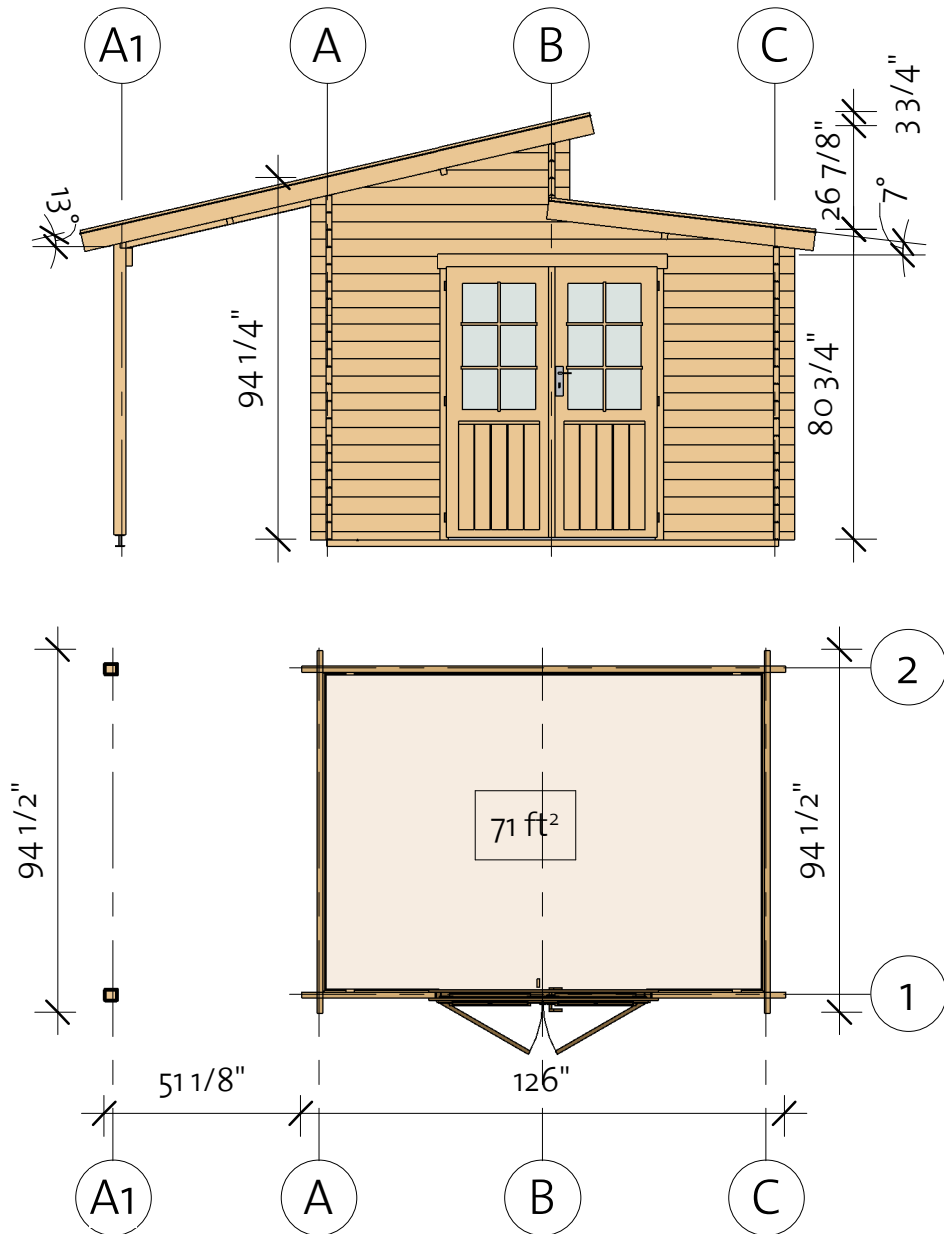

210510

 **EZ Log Structures**  
Do-It-Yourself Building Kits

# Mason Mini 40 (118 1/8" x 86 5/8")

Foundation

Impregnated foundation beams				
Mark	Type	Profile	Count	Length
IFB	IFB 70x40		5	117 3/4"

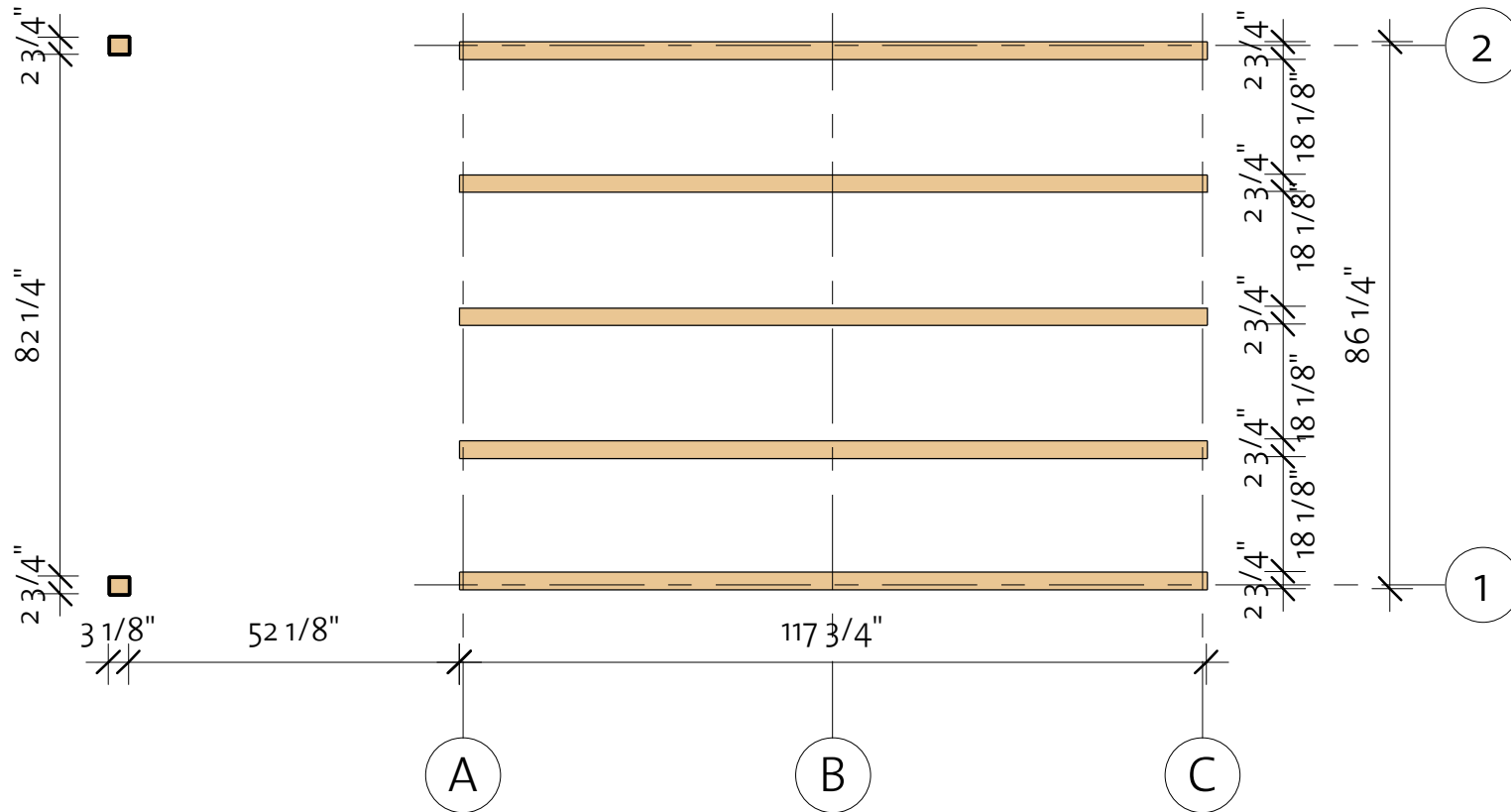

# Mason Mini 40 (118 1/8" x 86 5/8")

Floor Plan

① Baseboard

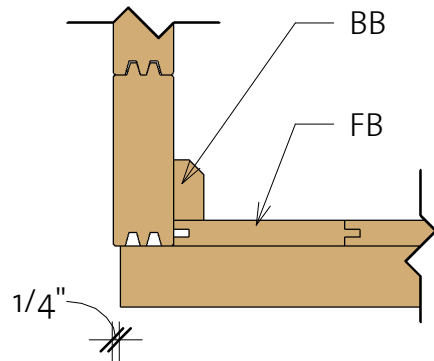

Floor Schedule

Mark	Type	Profile	Count	Length
------	------	---------	-------	--------

FB	FB 17x114		27	83 1/4"
----	-----------	--	----	---------

BB	BB 20x40		2	86 5/8"
BB	BB 20x40		2	118 1/8"

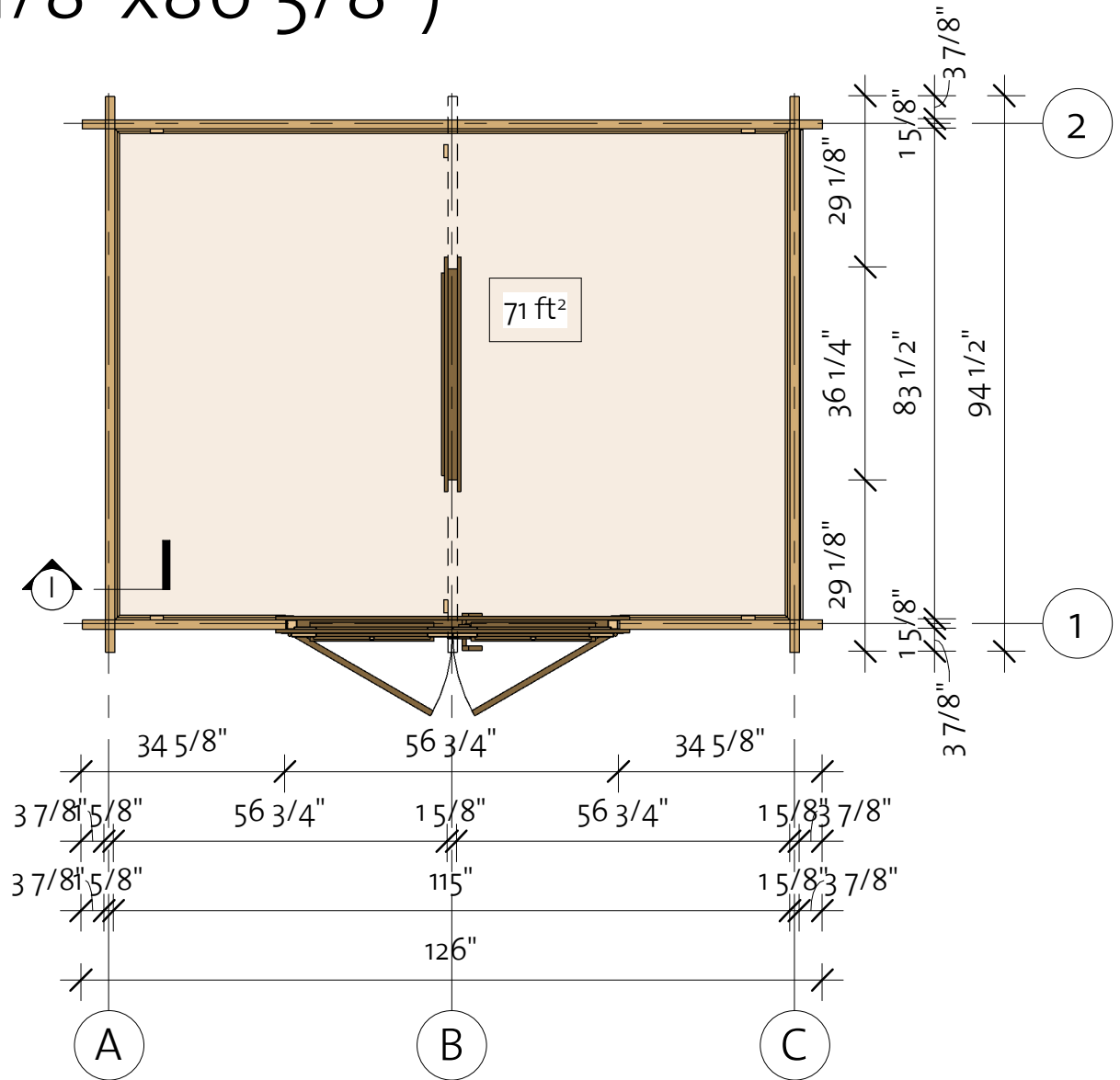

# Mason Mini 40 (118 1/8" x 86 5/8")

Wall 1

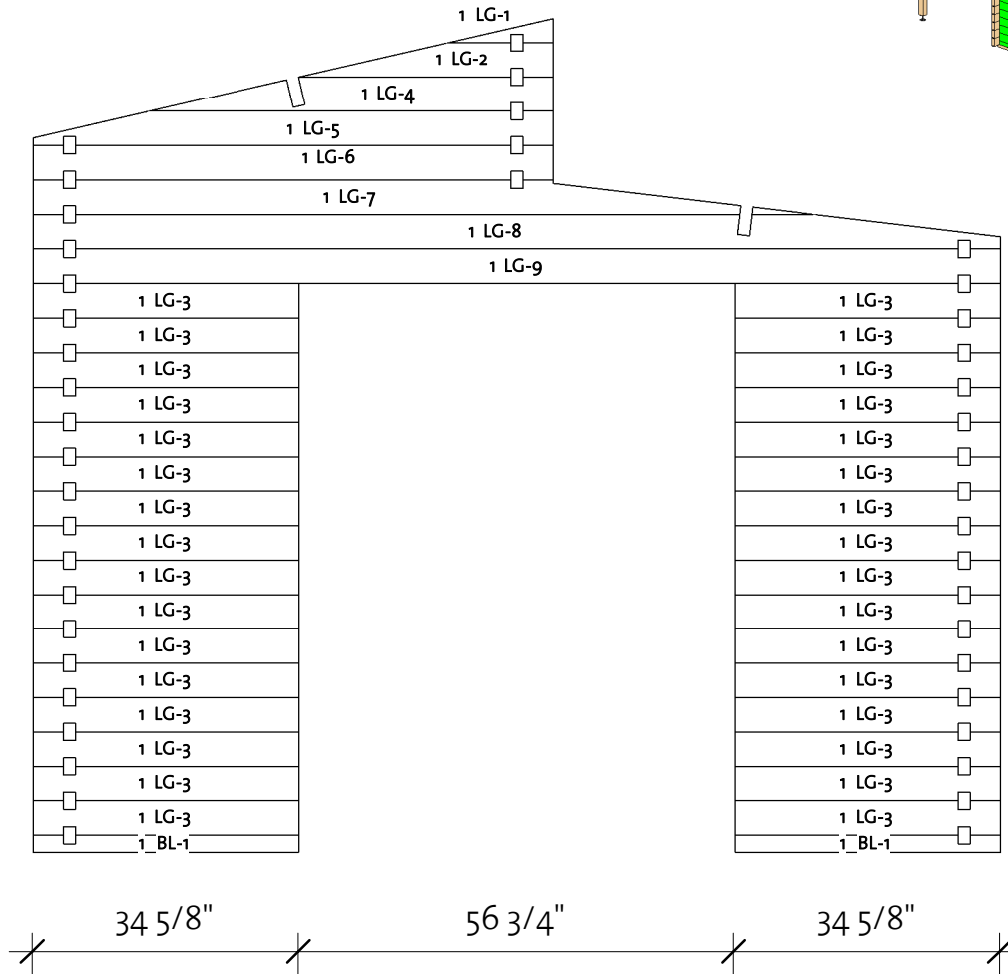
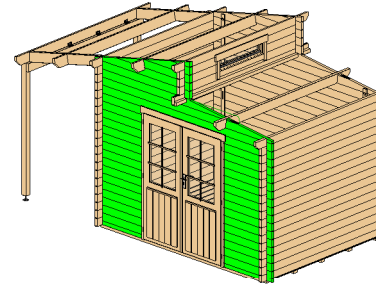



Wall 1			
Mark	Profile	Count	Cut Length

1BL-1	40X57	2	34 5/8"
1LG-1*	40X114	1	13 5/8"
1LG-2*	40X114	1	33"
1LG-3	40X114	32	34 5/8"
1LG-4*	40X114	1	52 1/2"
1LG-5*	40X114	1	67 3/4"
1LG-6*	40X114	1	67 3/4"
1LG-7*	40X114	1	101 5/8"
1LG-8*	40X114	1	126"
1LG-9	40X114	1	126"

\* Gable - delivered premounted

Log Profile Wall 1	
Profile	Profile

40X57	
40X114	

# Mason Mini 40 (118 1/8" x 86 5/8")

Wall 2

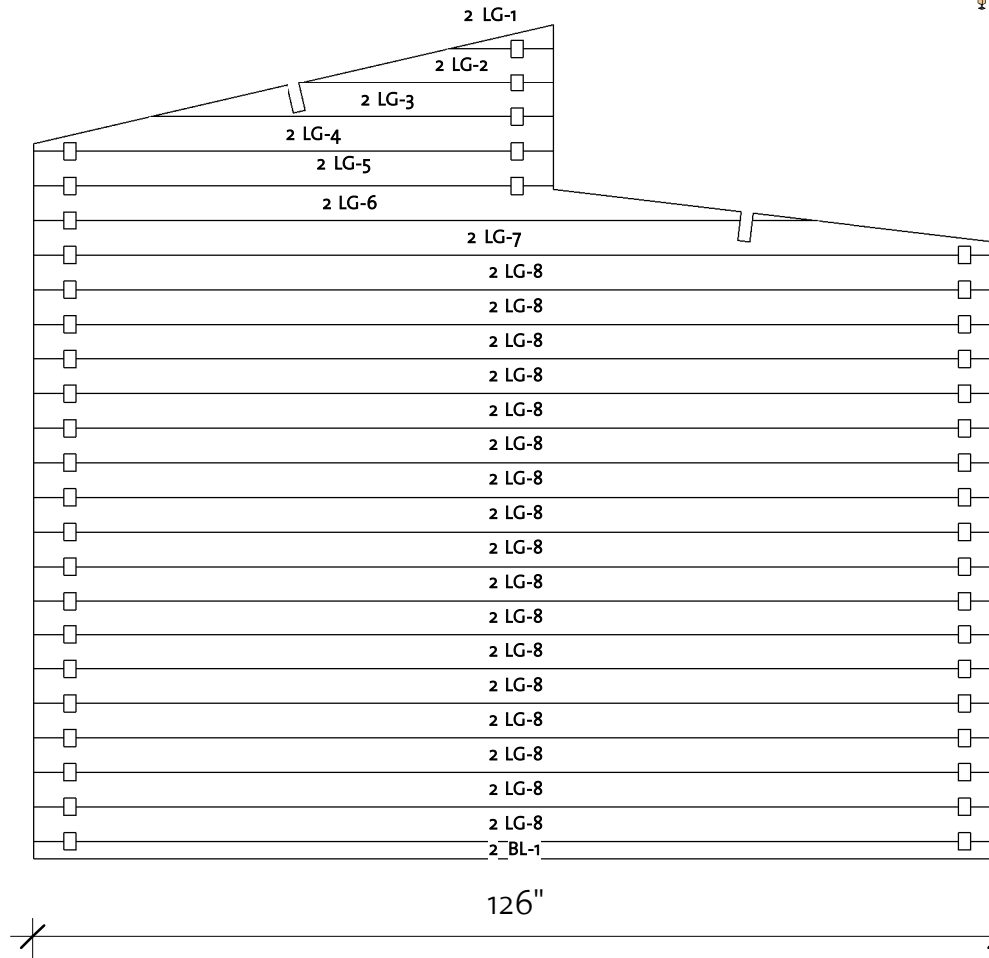
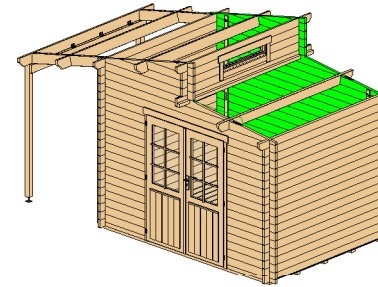

Wall 2			
Mark	Profile	Count	Cut Length

2BL-1	40X57	1	126"
2LG-1*	40X114	1	13 5/8"
2LG-2*	40X114	1	33"
2LG-3*	40X114	1	52 1/2"
2LG-4*	40X114	1	67 3/4"
2LG-5*	40X114	1	67 3/4"
2LG-6*	40X114	1	101 5/8"
2LG-7*	40X114	1	126"
2LG-8	40X114	17	126"

\* Gable - delivered premounted

Log Profile Wall 2	
Profile	Profile

40X57	
40X114	

# Mason Mini 40 (118 1/8" x 86 5/8")

Wall A

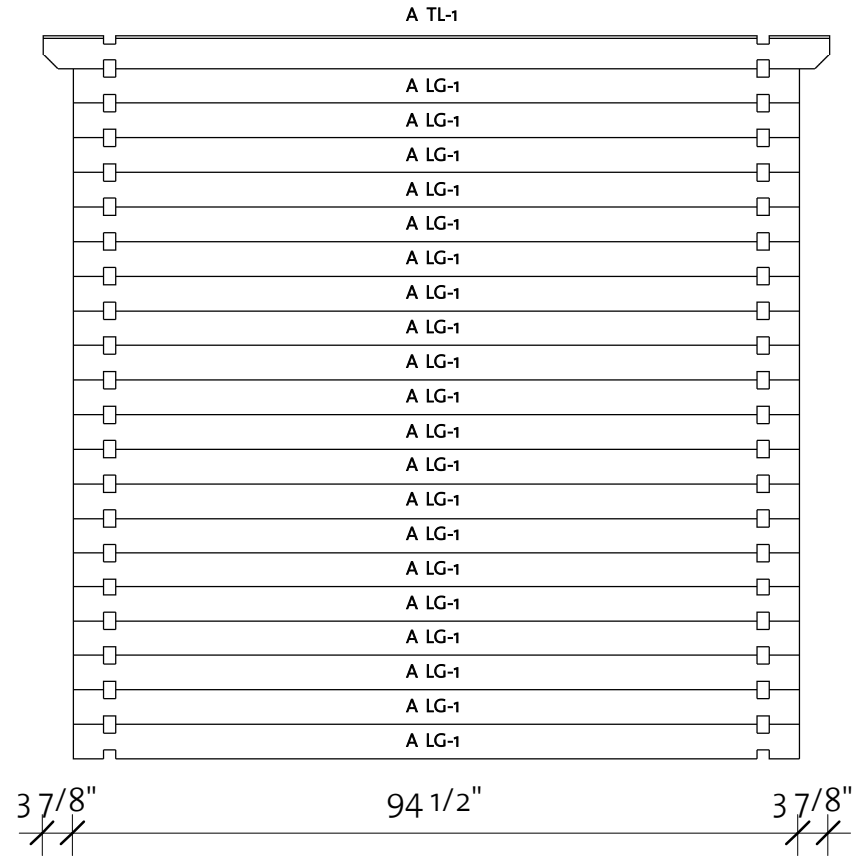
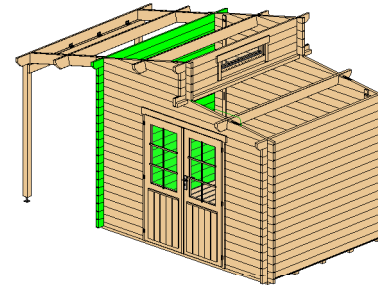

Wall A			
Mark	Profile	Count	Cut Length

ALG-1	40X114	20	94 1/2"
ATL-1	40X114	1	102 3/8"

Log Profile Wall A	
Profile	Profile

40X114	
40X114	

# Mason Mini 40 (118 1/8" x 86 5/8")

Wall B

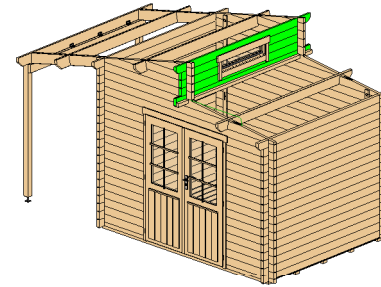

Wall B			
Mark	Profile	Count	Cut Length

BLG-1	4OX114	4	29 1/8"
BLG-2	4OX114	1	94 1/2"
BLG-3	4OX114	1	102 3/8"
BTL-1	4OX114	1	102 3/8"

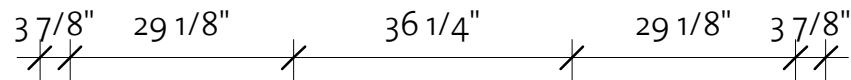
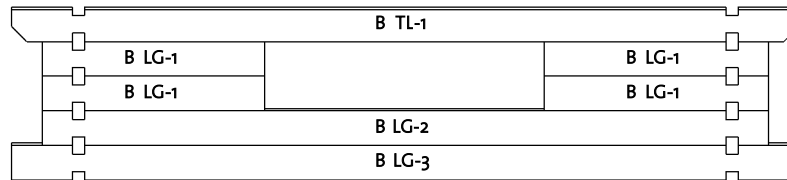

Log Profile Wall B	
Profile	Profile

4OX114	
4OX114	

# Mason Mini 40 (118 1/8" x 86 5/8")

Wall C

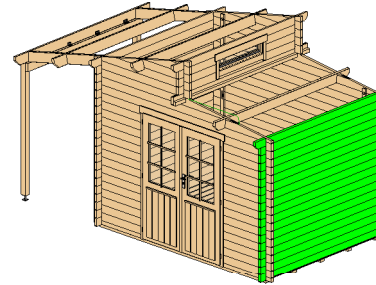

Wall C			
Mark	Profile	Count	Cut Length

CLG-1	4OX114	17	94 1/2"
CTL-1	4OX114	1	102 3/8"

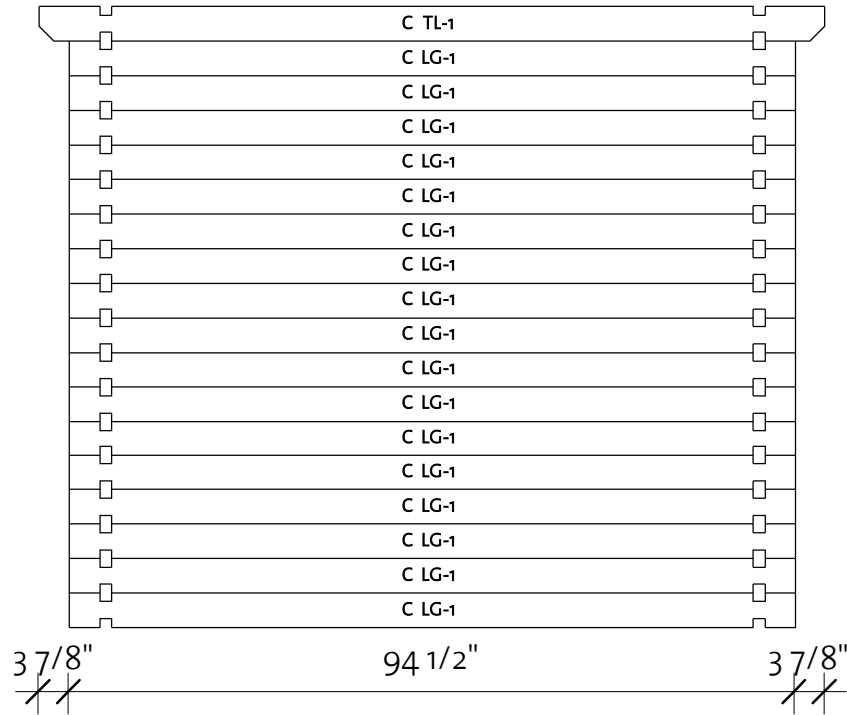

Log Profile Wall C	
Profile	Profile

4OX114	
4OX114	



# Mason Mini 40 (118 1/8" x 86 5/8")

Roof 1

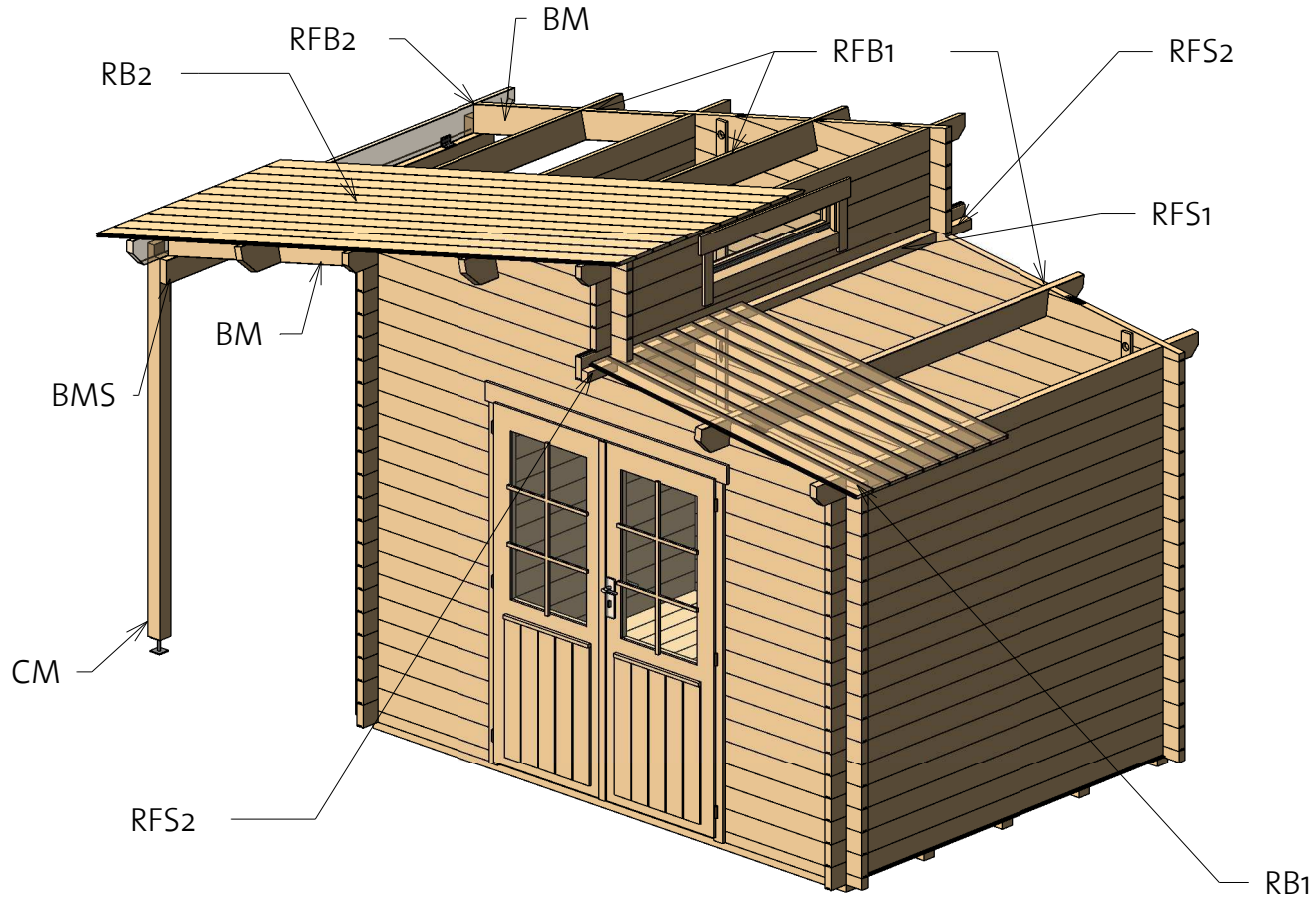

Roof				
Mark	Type	Profile	Count	Length

RB1	17x114		24	66 1/2"
RB2	17x114		24	133 1/2"
BM	Beam 40x143		2	54 5/8"
RFB1	Beam 40x143		3	102 3/8"
RFB2	Beam 40x143		1	102 3/8"

RFS1	40x55		1	83 1/2"
RFS2	40x55		2	77/8"

Columns			
Mark	Profile	Count	Length
CM	Post 70x80	2	77"

BMS	Beam 40x120		1	87 3/4"
-----	-------------	--	---	---------

210510

# Mason Mini 40 (118 1/8" x 86 5/8")

Roof 2

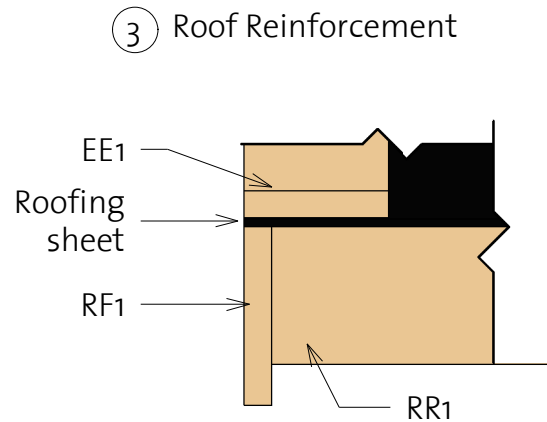
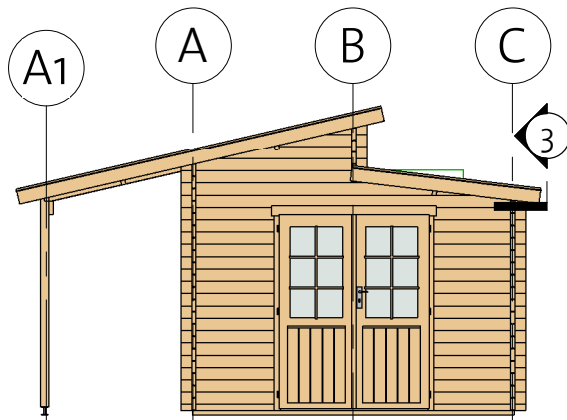
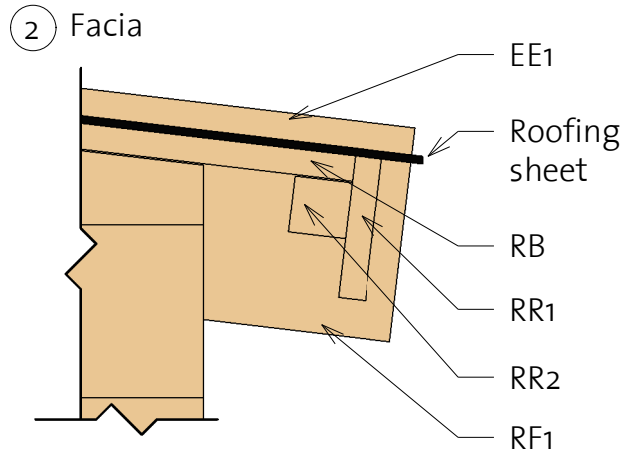
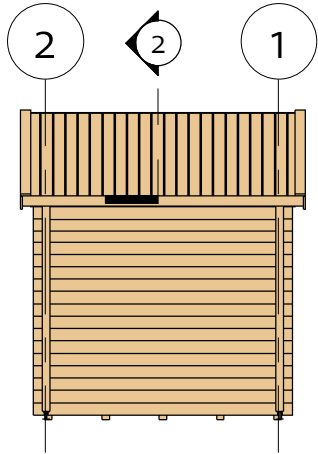

Fascia Schedule

Mark	Type	Profile	Count	Length
EE1	Eave Edging 18x95		2	69 5/8"
EE2	Eave Edging 18x95		2	136 1/4"
RF1	Roof Fascia 18x120		2	69 5/8"
RF2	Roof Fascia 18x120		2	136 1/4"
RR1	Roof reinforcement 18x95		3	102 3/8"
RR2	Roof reinforcement 38x38		3	102 3/8"

# Mason Mini 40 (118 1/8" x 86 5/8")

Extras

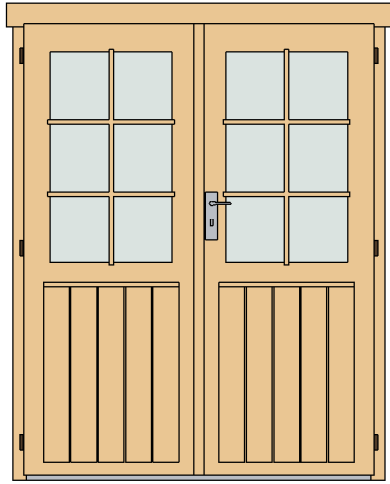

Door Schedule				
Mark	Type	Width	Height	Count
CDD12R	Classic double door 12 right	56 1/8"	72 1/4"	1
DCB6	Door Crossbar 6	--	--	1/8"

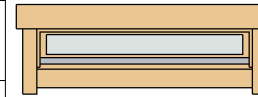

Window Schedule				
Mark	Type	Width	Height	Count
CW9R	Classic window 9, full glass right	36"	77/8"	1

Fasteners & Extras		
Name	Type	Count

Hitblock	300-400 mm	
Adjustable post foot		2
Angle bracket	40x40x60	4
Bolts	M8 x 70	16
Screws	5,0 x 70	25
Screws	5,0 x 40	24
Nails	1,4 x 40	30
Screws	6,0 x 140	45
Screws	4,0 x 40	420

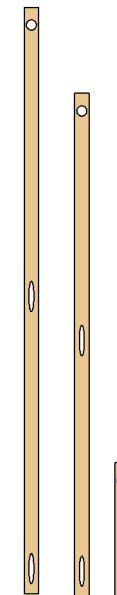

Type	Count	Length
Windboard3 18x40	2	20 7/8"
Windboard2 18x40	2	78 3/4"
Windboard1 18x40	2	91 3/4"

# Mason Mini 40 (118 1/8"x86 5/8")

## List of all items 1

### Impregnated foundation beams

Mark	Type	Profile	Count	Length
------	------	---------	-------	--------

IFB	IFB 70x40		5	117 3/4"
-----	--------------	---	---	----------

### Roof

Mark	Type	Profile	Count	Length
------	------	---------	-------	--------

RB1	17x114		24	66 1/2"
-----	--------	---	----	---------

RB2	17x114		24	133 1/2"
-----	--------	---	----	----------

BM	Beam 40x143		2	54 5/8"
----	----------------	---	---	---------

RFB1	Beam 40x143		3	102 3/8"
------	----------------	---	---	----------

RFB2	Beam 40x143		1	102 3/8"
------	----------------	---	---	----------

BMS	Beam 40x120		1	87 3/4"
-----	----------------	---	---	---------

### Floor Schedule

Mark	Type	Profile	Count	Length
------	------	---------	-------	--------

FB	FB 17x114		27	83 1/4"
----	-----------	---	----	---------

BB	BB 20x40		2	86 5/8"
----	-------------	---	---	---------

BB	BB 20x40		2	118 1/8"
----	-------------	--	---	----------

RFS1	40x55		1	83 1/2"
------	-------	---	---	---------

RFS2	40x55		2	77/8"
------	-------	--	---	-------







### Columns

Mark	Profile	Count	Length
------	---------	-------	--------

CM	Post 70x80	2	77"
----	------------	---	-----

# Mason Mini 40 (118 1/8"x86 5/8")

## List of all items 2

Fascia Schedule				
Mark	Type	Profile	Count	Length
EE1	Eave Edging 18x95		2	69 5/8"
EE2	Eave Edging 18x95		2	136 1/4"
RF1	Roof Fascia 18x120		2	69 5/8"
RF2	Roof Fascia 18x120		2	136 1/4"
RR1	Roof reinforcement 18x95		3	102 3/8"
RR2	Roof reinforcement 38x38		3	102 3/8"

# Mason Mini 40 (118 1/8" x 86 5/8")

## List of all items 3

Wall 1			
Mark	Profile	Count	Cut Length



1BL-1	40X57	2	34 5/8"
1LG-1 *	40X114	1	13 5/8"
1LG-2 *	40X114	1	33"
1LG-3	40X114	32	34 5/8"
1LG-4 *	40X114	1	52 1/2"
1LG-5 *	40X114	1	67 3/4"
1LG-6 *	40X114	1	67 3/4"
1LG-7 *	40X114	1	101 5/8"
1LG-8 *	40X114	1	126"
1LG-9	40X114	1	126"

\* Gable - delivered premounted

Wall A			
Mark	Profile	Count	Cut Length

ALG-1	40X114	20	94 1/2"
ATL-1	40X114	1	102 3/8"

Log Profiles	
Profile	Profile

40X57	
40X114	

Wall 2			
Mark	Profile	Count	Cut Length

2BL-1	40X57	1	126"
2LG-1 *	40X114	1	13 5/8"
2LG-2 *	40X114	1	33"
2LG-3 *	40X114	1	52 1/2"
2LG-4 *	40X114	1	67 3/4"
2LG-5 *	40X114	1	67 3/4"
2LG-6 *	40X114	1	101 5/8"
2LG-7 *	40X114	1	126"
2LG-8	40X114	17	126"

Wall B			
Mark	Profile	Count	Cut Length

BLG-1	40X114	4	29 1/8"
BLG-2	40X114	1	94 1/2"
BLG-3	40X114	1	102 3/8"
BTL-1	40X114	1	102 3/8"

Wall C			
Mark	Profile	Count	Cut Length

CLG-1	40X114	17	94 1/2"
CTL-1	40X114	1	102 3/8"

Log Profiles	
Profile	Profile

40X114	
--------	---