

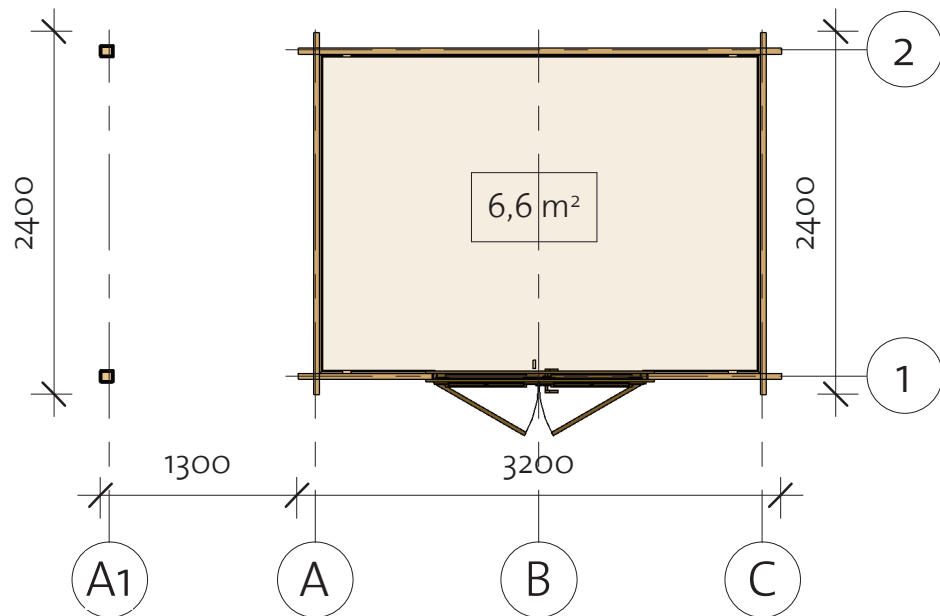

Mason Mini 40 (300x220)

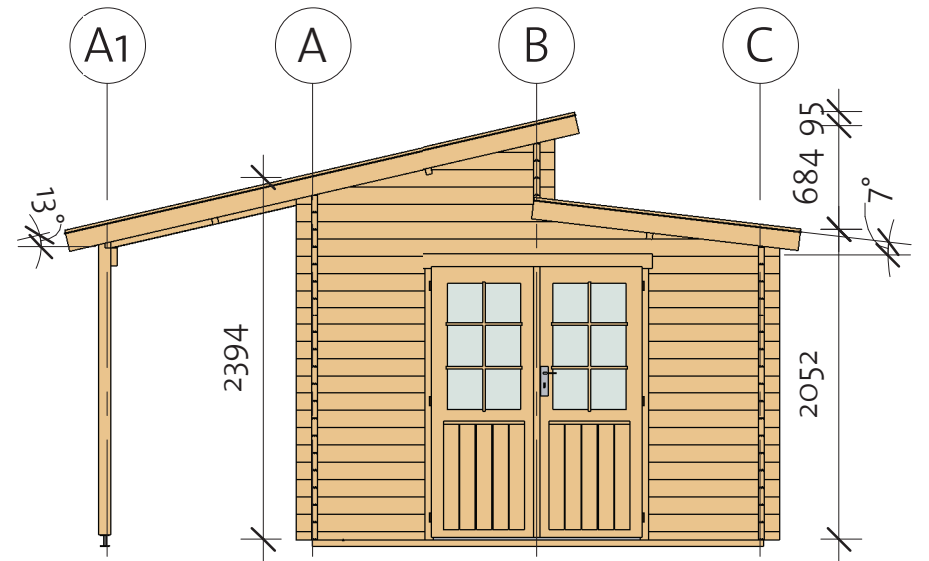

210510

Mason Mini 40 (300x220)

Foundation

Impregnated foundation beams				
Mark	Type	Profile	Count	Length
IFB	IFB 70x40		5	2990

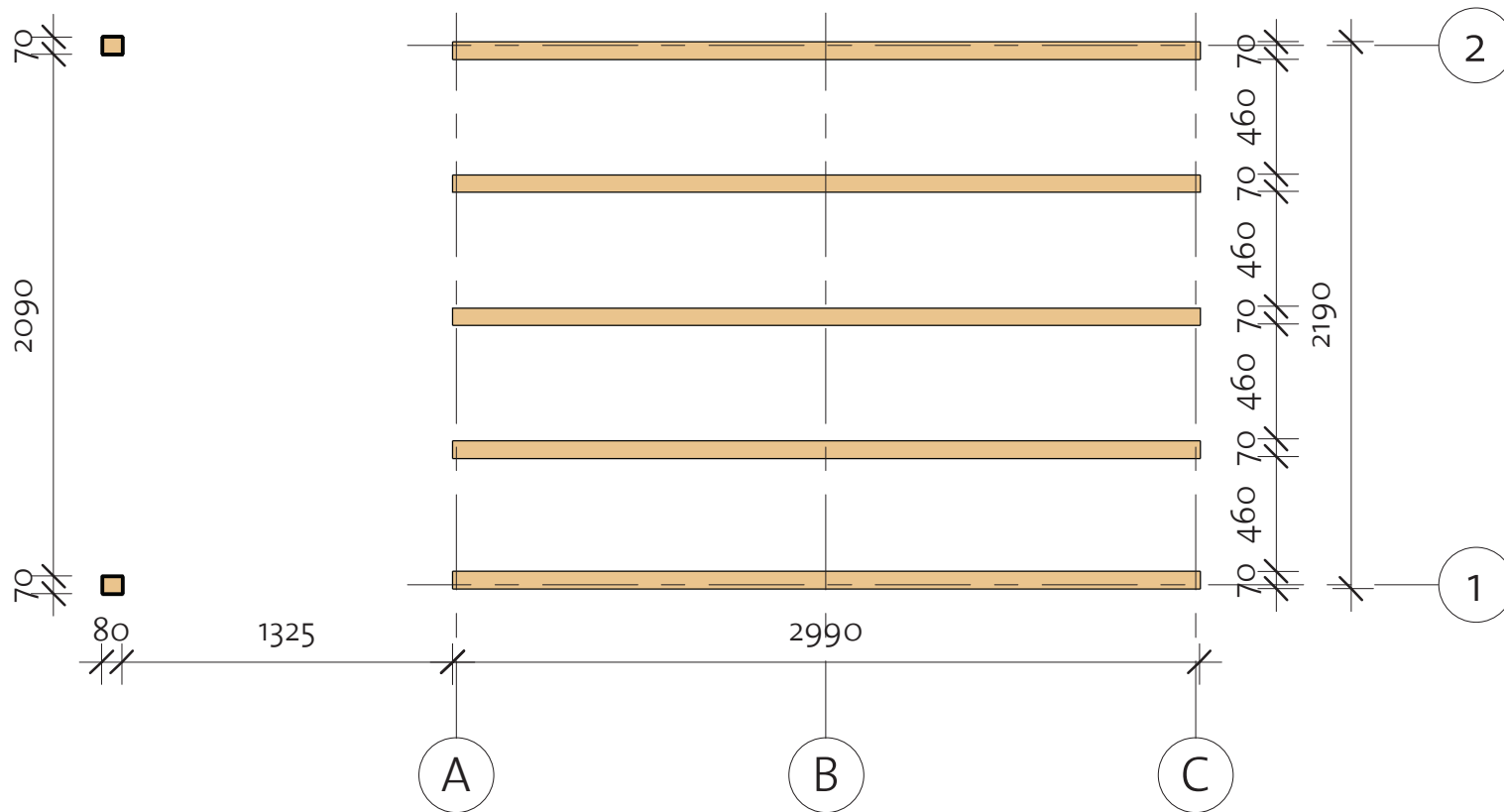

Mason Mini 40 (300x220)

Floor Plan

① Baseboard

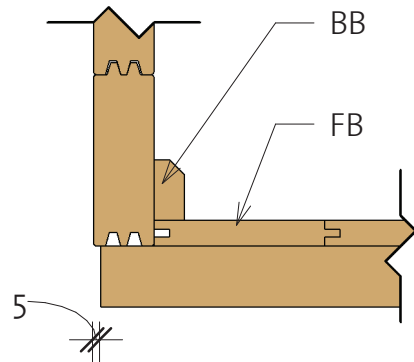

Floor Schedule

Mark	Type	Profile	Count	Length
------	------	---------	-------	--------

FB	FB 17x114		27	2114
----	-----------	--	----	------

BB	BB 20x40		2	2200
BB	BB 20x40		2	3000

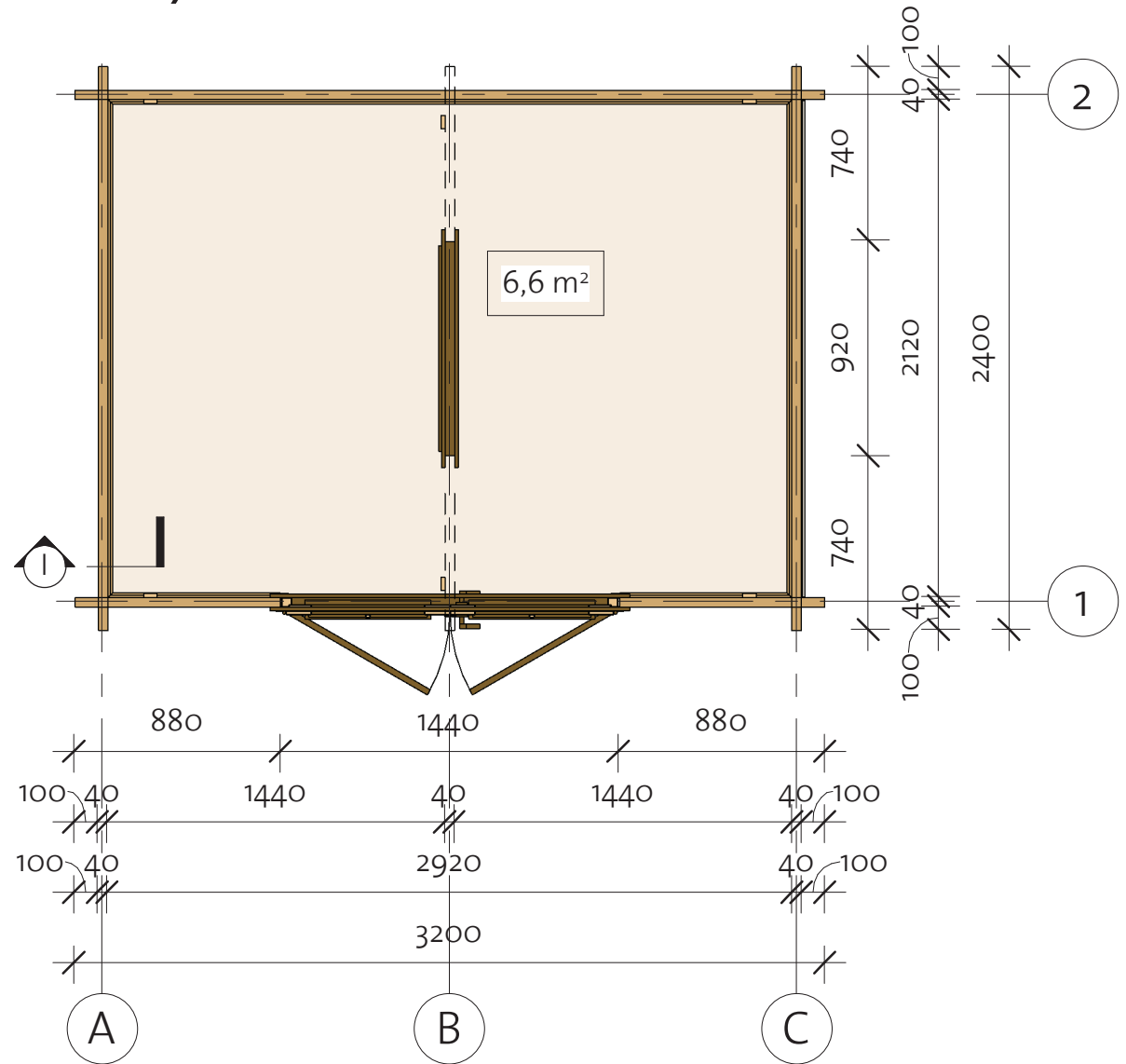

Mason Mini 40 (300x220)

Wall 1

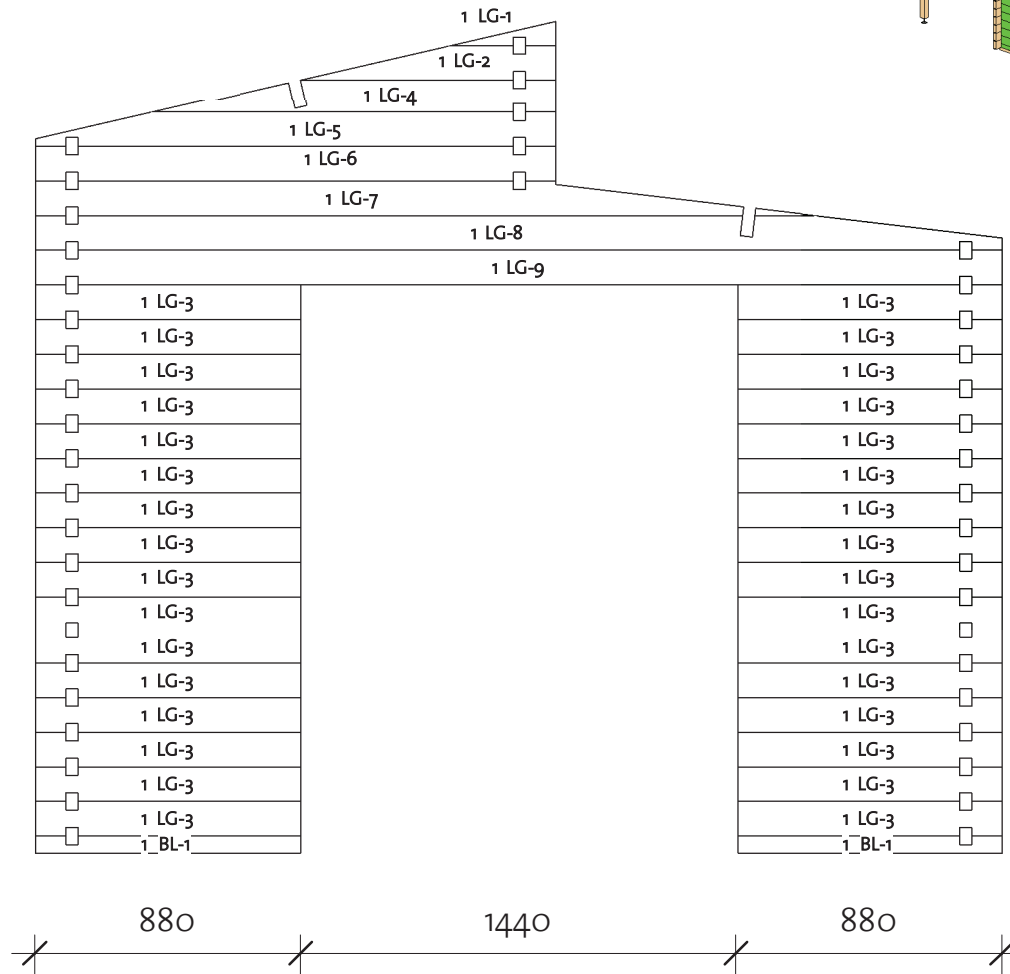
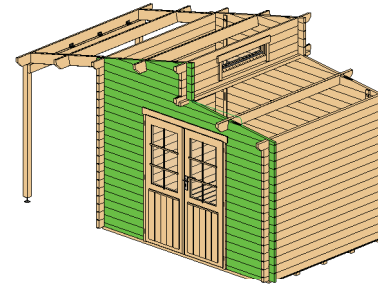



Wall 1			
Mark	Profile	Count	Cut Length

1BL-1	40X57	2	880
1LG-1*	40X114	1	346
1LG-2*	40X114	1	839
1LG-3	40X114	32	880
1LG-4*	40X114	1	1333
1LG-5*	40X114	1	1720
1LG-6*	40X114	1	1720
1LG-7*	40X114	1	2580
1LG-8*	40X114	1	3200
1LG-9	40X114	1	3200

* Gable - delivered premounted

Log Profile Wall 1	
Profile	Profile

40X57	
40X114	

Mason Mini 40 (300x220)

Wall 2

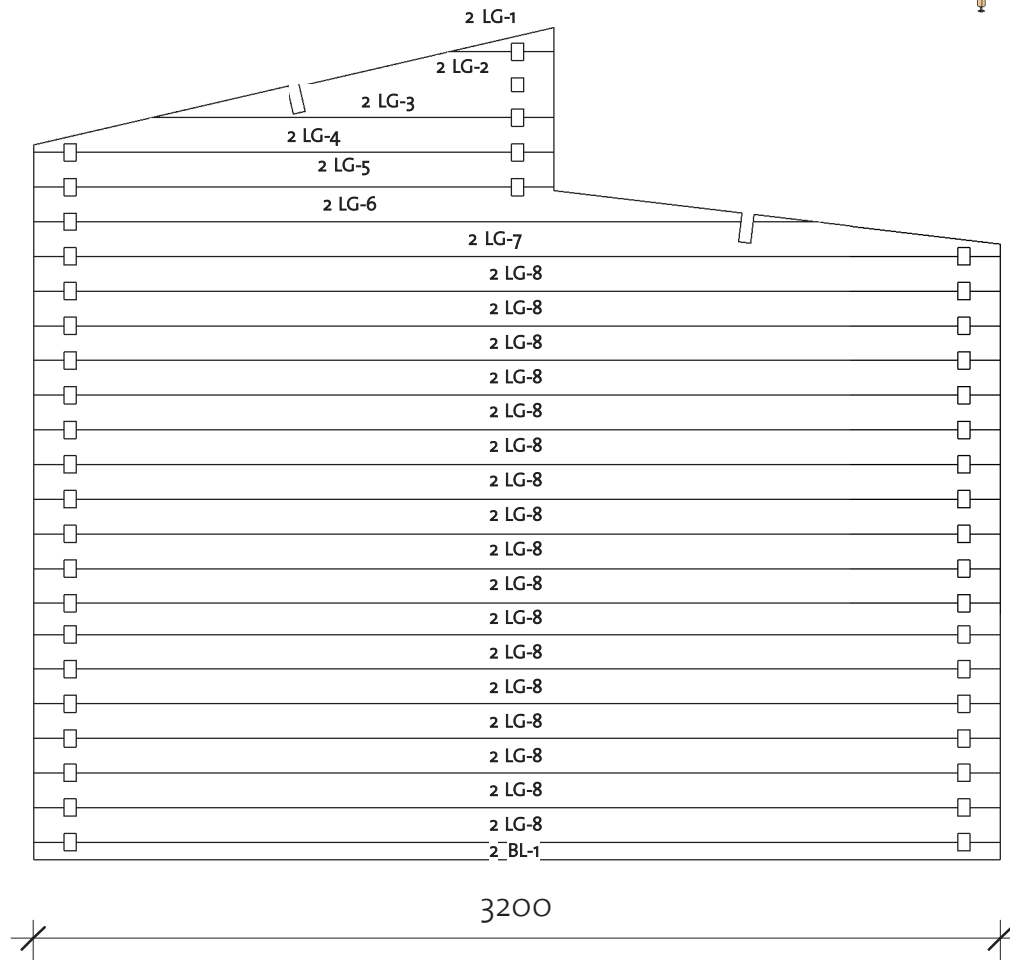
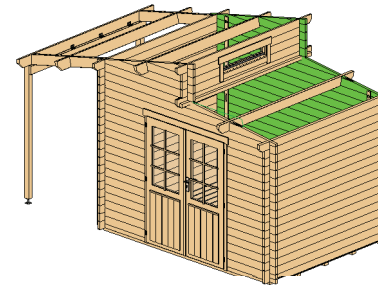



Wall 2			
Mark	Profile	Count	Cut Length

2BL-1	40X57	1	3200
2LG-1*	40X114	1	346
2LG-2*	40X114	1	839
2LG-3*	40X114	1	1333
2LG-4*	40X114	1	1720
2LG-5*	40X114	1	1720
2LG-6*	40X114	1	2580
2LG-7*	40X114	1	3200
2LG-8	40X114	17	3200

* Gable - delivered premounted

Log Profile Wall 2	
Profile	Profile

40X57	
40X114	

Mason Mini (300x220)

Wall B

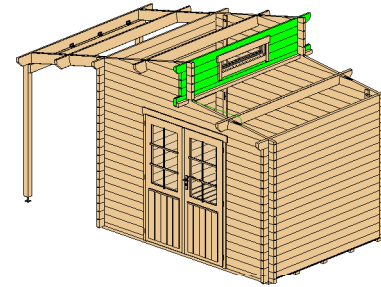

Wall B			
Mark	Profile	Count	Cut Length

BLG-1	40X114	4	740
BLG-2	40X114	1	2400
BLG-3	40X114	1	2600
BTL-1	40X114	1	2600

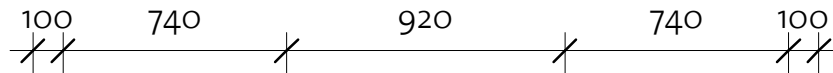
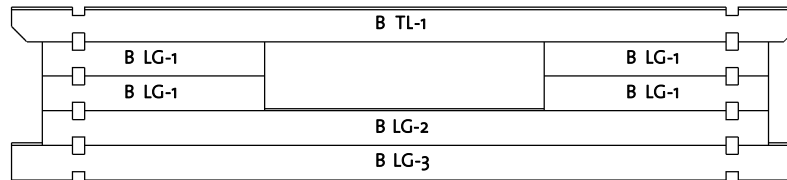

Log Profile Wall B	
Profile	Profile

40X114	
40X114	

Mason Mini (300x220)

Roof 1

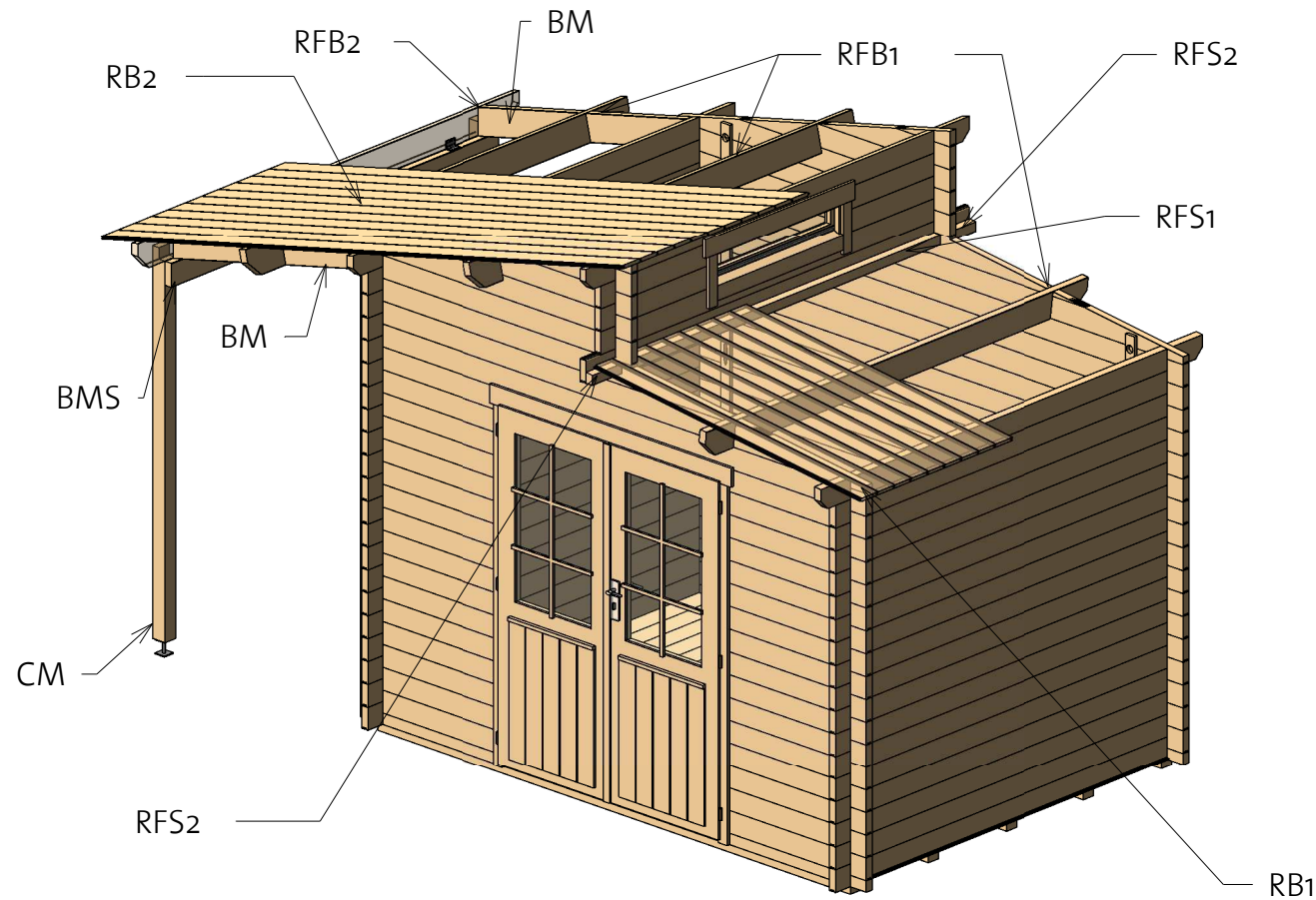

Roof				
Mark	Type	Profile	Count	Length

RB1	17x114		24	1690
RB2	17x114		24	3390
BM	Beam 40x143		2	1388
RFB1	Beam 40x143		3	2600
RFB2	Beam 40x143		1	2600

RFS1	40x55		1	2120
RFS2	40x55		2	200

Columns			
Mark	Profile	Count	Length
CM	Post 70x80	2	1957

BMS	Beam 40x120		1	2230
-----	-------------	--	---	------

210510

Mason Mini (300x220)

Roof 2

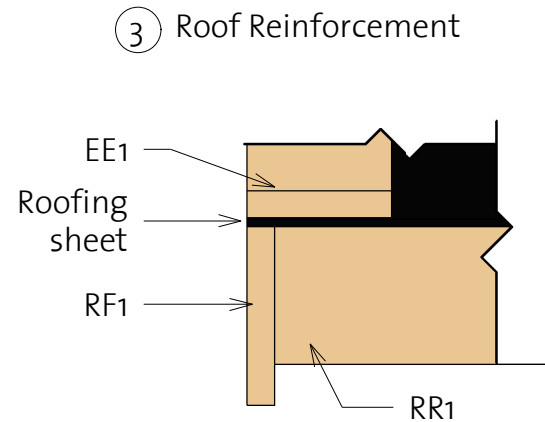
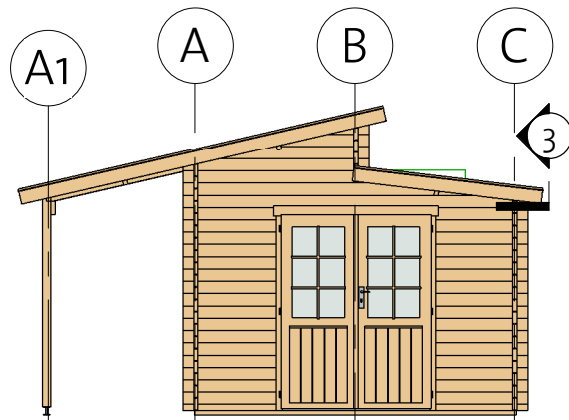
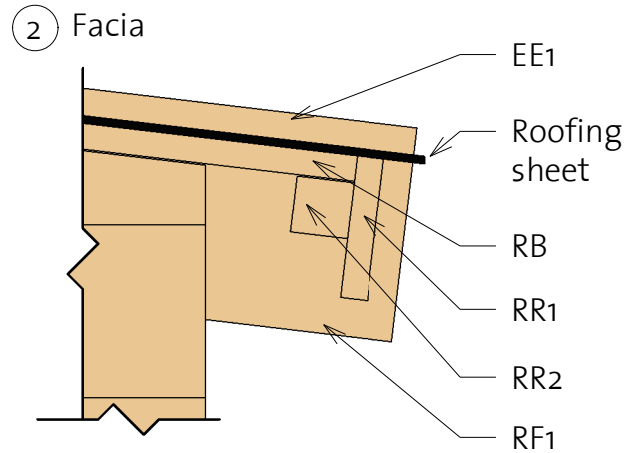
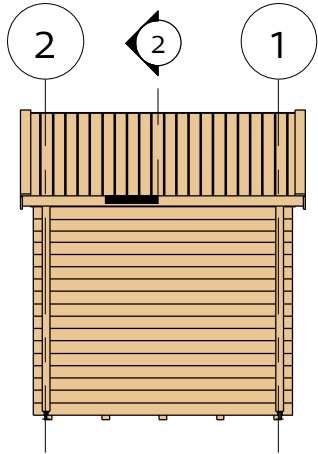

Fascia Schedule				
Mark	Type	Profile	Count	Length
EE1	Eave Edging 18x95		2	1770
EE2	Eave Edging 18x95		2	3460
RF1	Roof Fascia 18x120		2	1770
RF2	Roof Fascia 18x120		2	3460
RR1	Roof reinforcement 18x95		3	2600
RR2	Roof reinforcement 38x38		3	2600

Mason Mini (300x220)

Extras

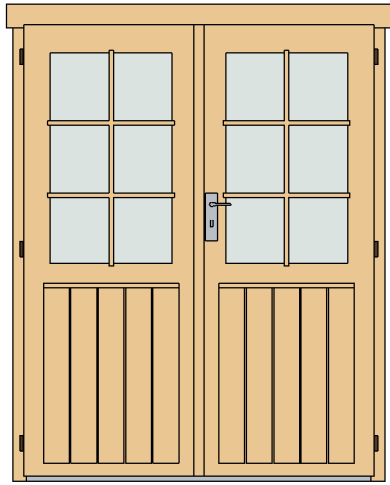

Door Schedule				
Mark	Type	Width	Height	Count
CDD12R	Classic double door 12 right	1425	1835	1
DCB6	Door Crossbar 6	--	--	2

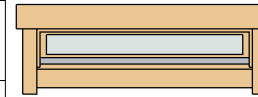

Window Schedule				
Mark	Type	Width	Height	Count
CW9R	Classic window 9, full glass right	915	200	1

Fasteners & Extras		
Name	Type	Count

Hitblock	300-400 mm	
Angle bracket	40x40x60	4
Bolts	M8 x 70	16
Screws	5,0 x 40	24
Screws	5,0 x 70	25
Nails	1,4 x 40	30
Screws	6,0 x 140	45
Screws	4,0 x 40	420

Family	Count
Adjustable post foot face based	2

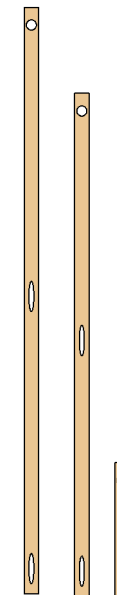

Type	Count	Length
Windboard3 18x40	2	530
Windboard2 18x40	2	2000
Windboard1 18x40	2	2330







Mason Mini (300x220)

List of all items 1



Impregnated foundation beams

Mark	Type	Profile	Count	Length
IFB	IFB 70x40		5	2990

Roof

Mark	Type	Profile	Count	Length
RB1	17x114		24	1690
RB2	17x114		24	3390
BM	Beam 40x143		2	1388
RFB1	Beam 40x143		3	2600
RFB2	Beam 40x143		1	2600
BMS	Beam 40x120		1	2230

Floor Schedule







Mark	Type	Profile	Count	Length
FB	FB 17x114		27	2114
BB	BB 20x40		2	2200
BB	BB 20x40		2	3000
RFS1	40x55		1	2120
RFS2	40x55		2	200

Columns

Mark	Profile	Count	Length
CM	Post 70x80	2	1957

Mason Mini (300x220)

List of all items 2

Fascia Schedule				
Mark	Type	Profile	Count	Length
EE1	Eave Edging 18x95		2	1770
EE2	Eave Edging 18x95		2	3460
RF1	Roof Fascia 18x120		2	1770
RF2	Roof Fascia 18x120		2	3460
RR1	Roof reinforcement 18x95		3	2600
RR2	Roof reinforcement 38x38		3	2600

Mason Mini (300x220)

List of all items 3

Wall 1			
Mark	Profile	Count	Cut Length



1BL-1	40X57	2	880
1LG-1 *	40X114	1	346
1LG-2 *	40X114	1	839
1LG-3	40X114	32	880
1LG-4 *	40X114	1	1333
1LG-5 *	40X114	1	1720
1LG-6 *	40X114	1	1720
1LG-7 *	40X114	1	2580
1LG-8 *	40X114	1	3200
1LG-9	40X114	1	3200

* Gable - delivered premounted

Wall A			
Mark	Profile	Count	Cut Length

ALG-1	40X114	20	2400
ATL-1	40X114	1	2600

Log Profiles	
Profile	Profile

40X57	
40X114	

Wall 2			
Mark	Profile	Count	Cut Length

2BL-1	40X57	1	3200
2LG-1 *	40X114	1	346
2LG-2 *	40X114	1	839
2LG-3 *	40X114	1	1333
2LG-4 *	40X114	1	1720
2LG-5 *	40X114	1	1720
2LG-6 *	40X114	1	2580
2LG-7 *	40X114	1	3200
2LG-8	40X114	17	3200

Wall B			
Mark	Profile	Count	Cut Length

BLG-1	40X114	4	740
BLG-2	40X114	1	2400
BLG-3	40X114	1	2600
BTL-1	40X114	1	2600

Wall C			
Mark	Profile	Count	Cut Length

CLG-1	40X114	17	2400
CTL-1	40X114	1	2600

Log Profiles	
Profile	Profile

40X114	
--------	---

Windboard

① Windboard Assembly 1



② Windboard Assembly 2

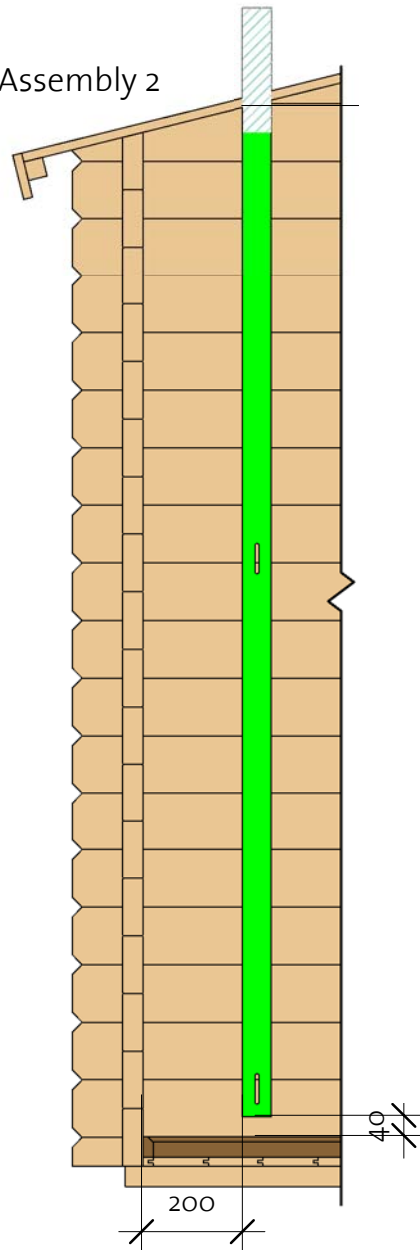

③ Windboard Assembly 3

