

Nevada 1 1/8" (131 7/8" x 107 7/8")

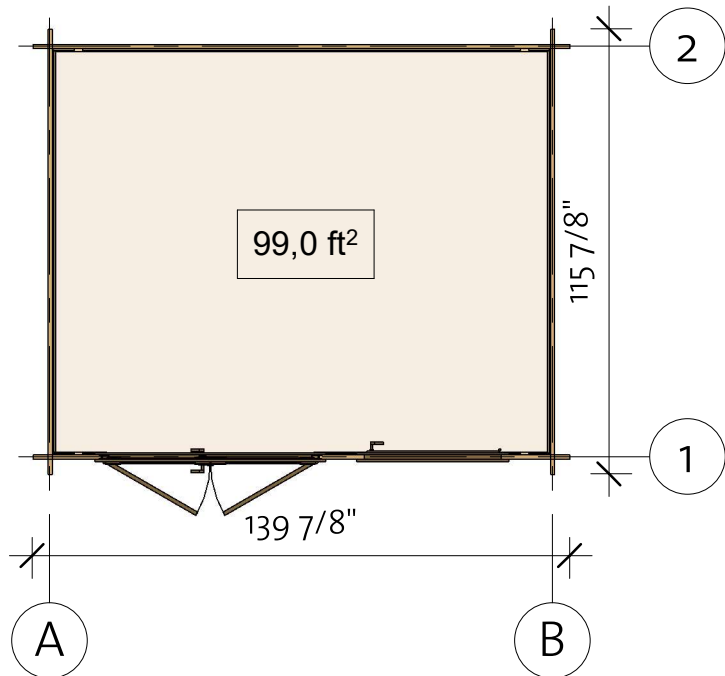
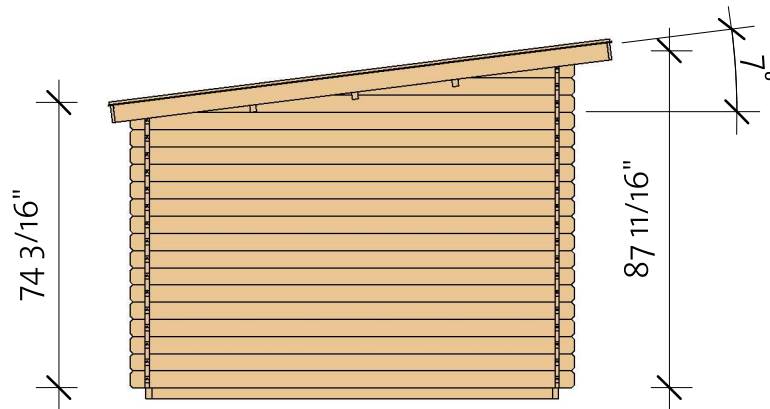

Nevada 1 1/8" (131 7/8" x 107 7/8")

Floor Plan

① Baseboard

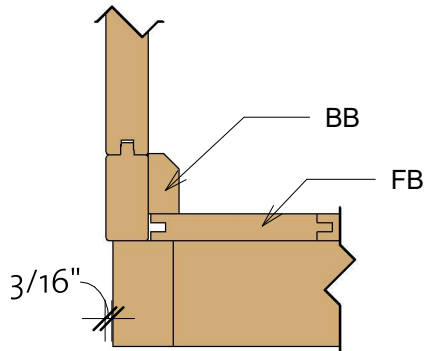

Floor Schedule				
Mark	Type	Profile	Count	Length

FB	FB 18x110		26	129 3/4"
----	-----------	--	----	----------

BB1	BB 20x40		2	110 1/4"
BB2	BB 20x40		2	133 7/8"

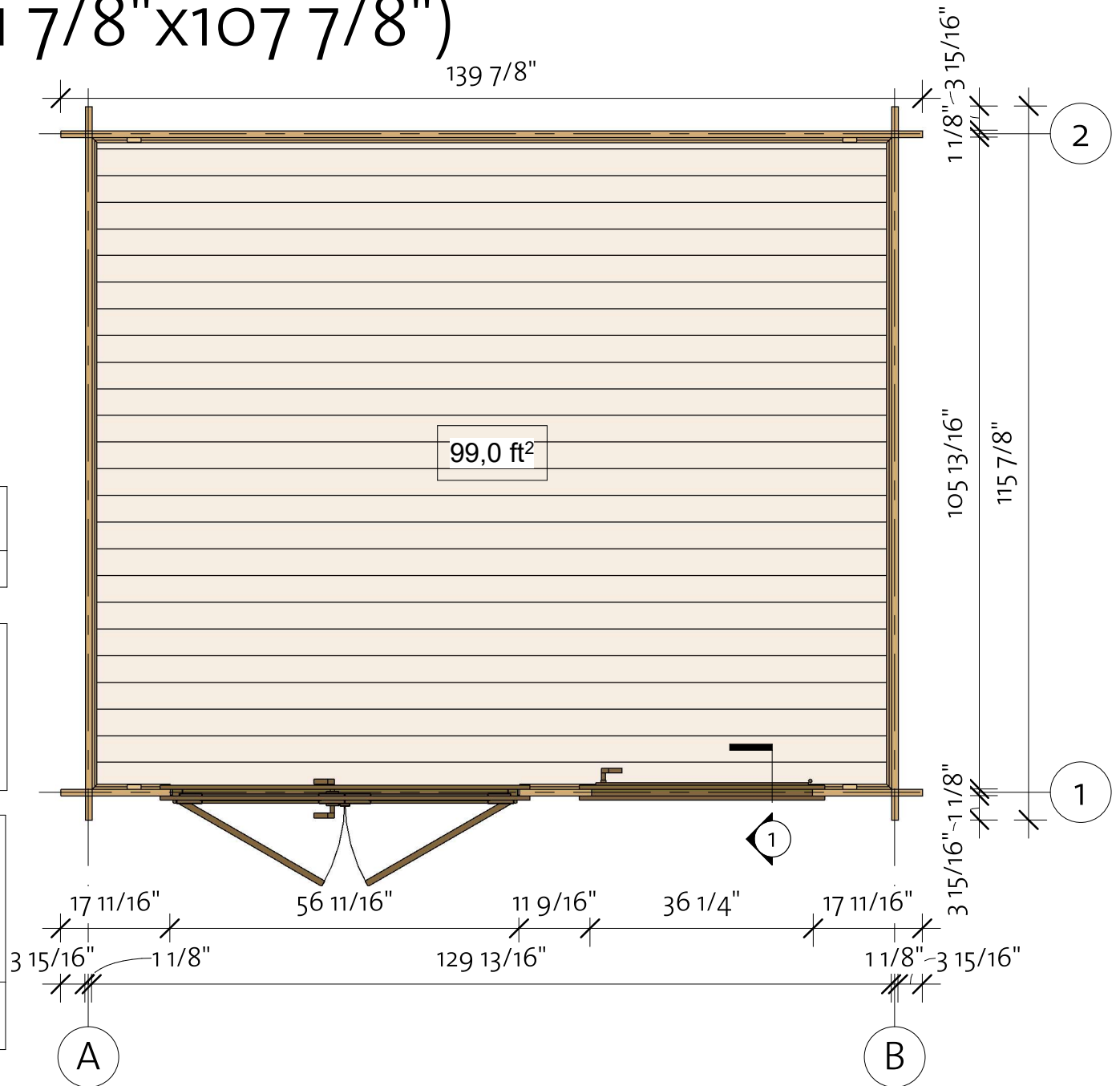

Nevada 1 1/8" (131 7/8" x 107 7/8")

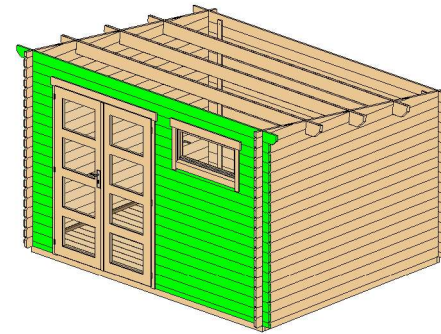

Wall 1



Wall 1			
Mark	Profile	Count	Cut Length

1BL 1	28x57	1	17 11/16"
1BL 2	28x57	1	65 1/2"
1LG 1	28x114	4	11 9/16"
1LG 2	28x114	21	17 11/16"
1LG 3	28x114	13	65 1/2"
1LG 4	28x114	1	139 7/8"
1TL 1	28x118	1	147 3/4"

Log Profile Wall 1	
Profile	Profile

28x57	
28x114	
28x118	

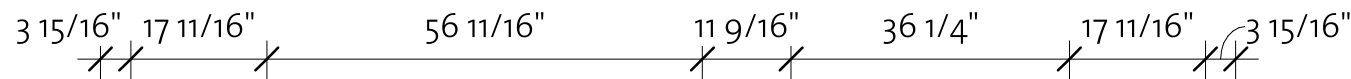
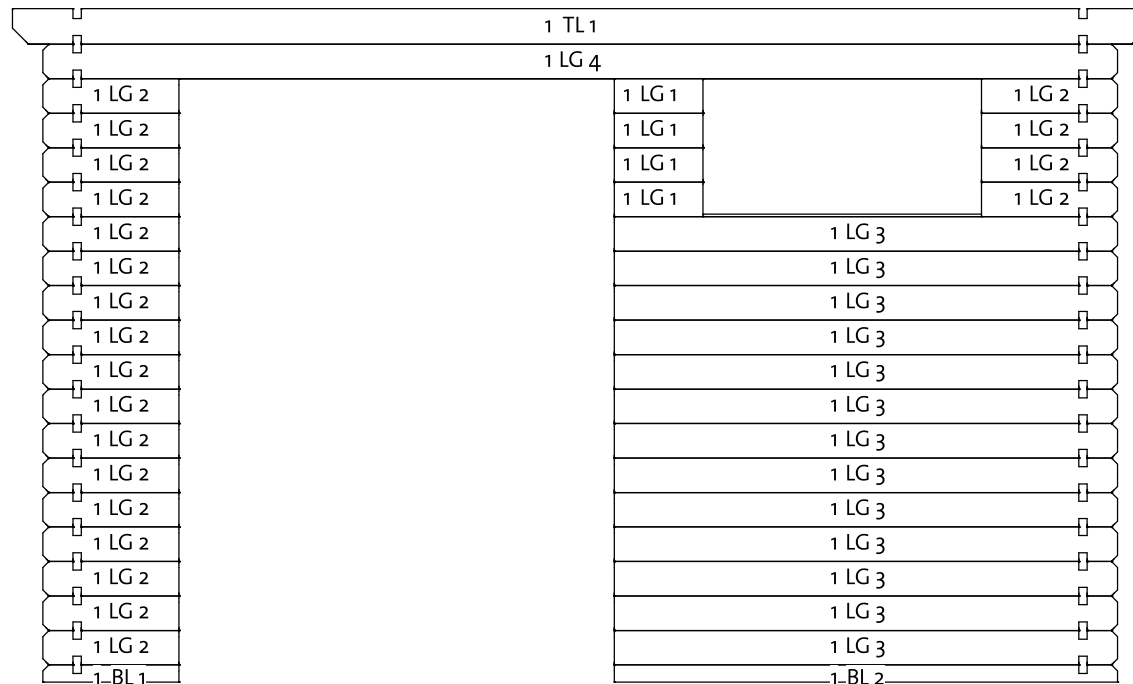

Nevada 1 1/8" (131 7/8" x 107 7/8")

Wall 2

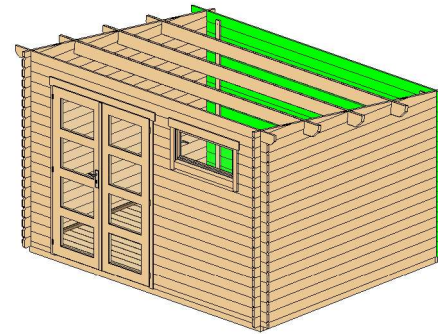

Wall 2			
Mark	Profile	Count	Cut Length

2BL 1	28x57	1	139 7/8"
2LG 1	28x114	15	139 7/8"
2TL 1	28x118	1	147 3/4"

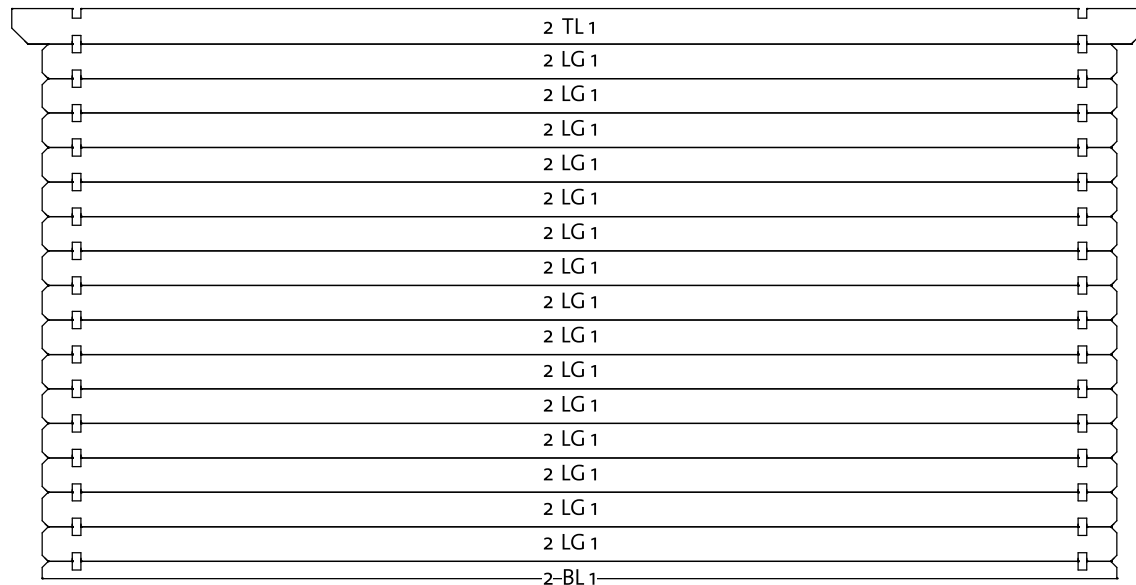

3 15/16"
//

139 7/8"

3 15/16"
//

Log Profile Wall 2	
Profile	Profile

28x57	
28x114	
28x118	

Nevada 1 1/8" (131 7/8" x 107 7/8")

Wall A

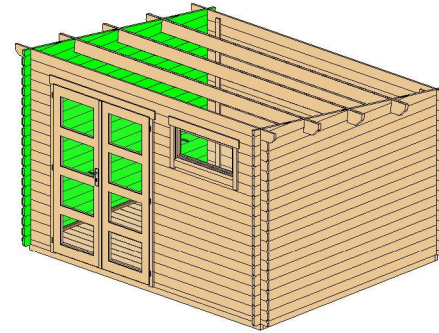

Wall A			
Mark	Profile	Count	Cut Length

ALG 1	28x114	1	22 15/16"
ALG 2	28x114	1	57 3/16"
ALG 3	28x114	1	94 1/4"
ALG 4	28x114	1	115 7/8"
ALG 5	28x114	16	115 7/8"

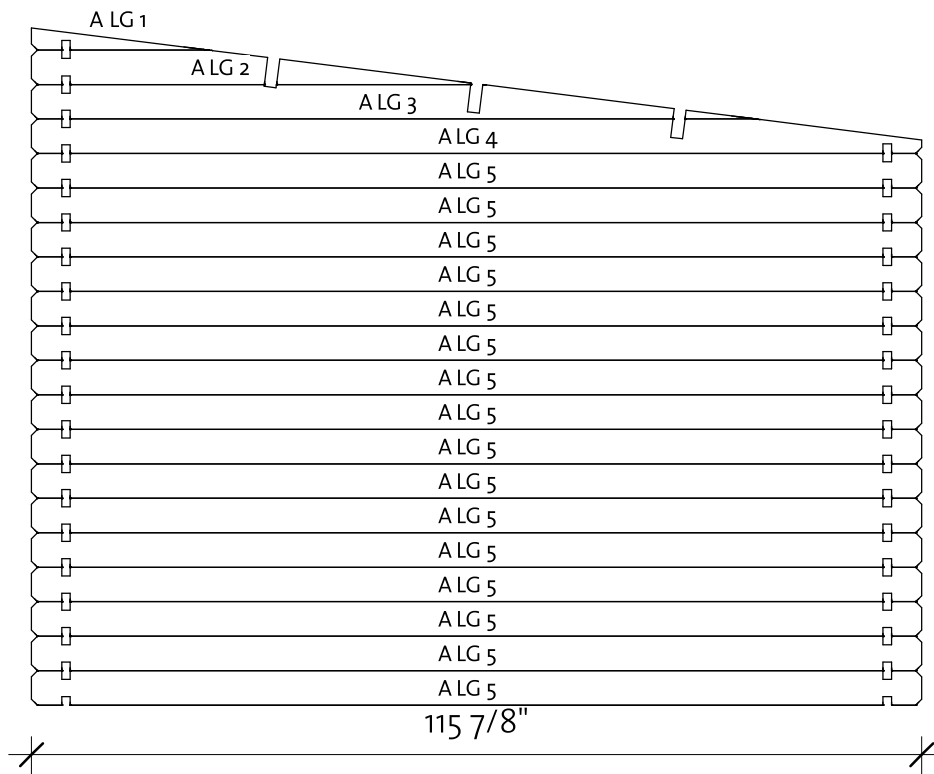

Log Profile Wall A	
Profile	Profile

28x114	
--------	--

Nevada 1 1/8" (131 7/8" x 107 7/8")

Wall B

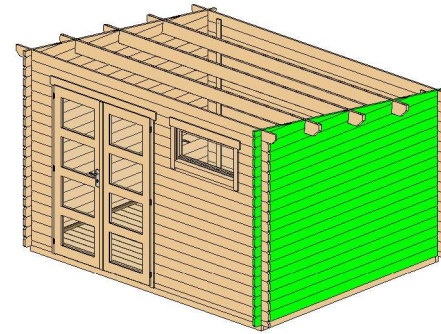

Wall B			
Mark	Profile	Count	Cut Length

BLG 1	28x114	1	22 15/16"
BLG 2	28x114	1	57 3/16"
BLG 3	28x114	1	94 1/4"
BLG 4	28x114	1	115 7/8"
BLG 5	28x114	16	115 7/8"

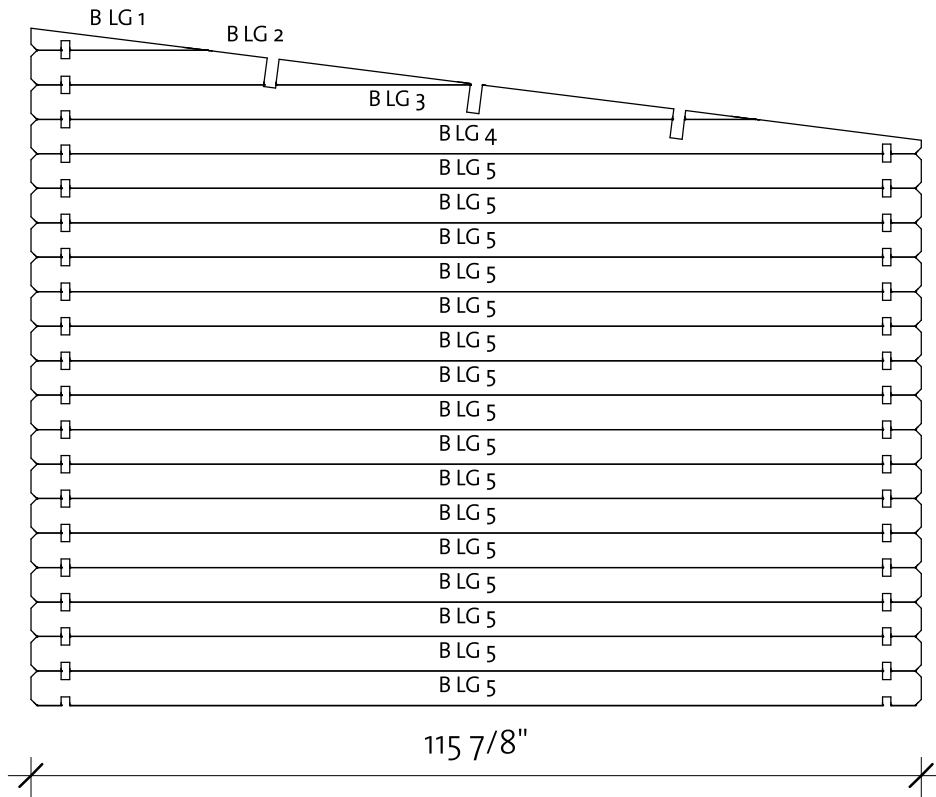



Log Profile Wall B	
Profile	Profile

28x114	
--------	---

Nevada 1 1/8" (131 7/8" x 107 7/8")

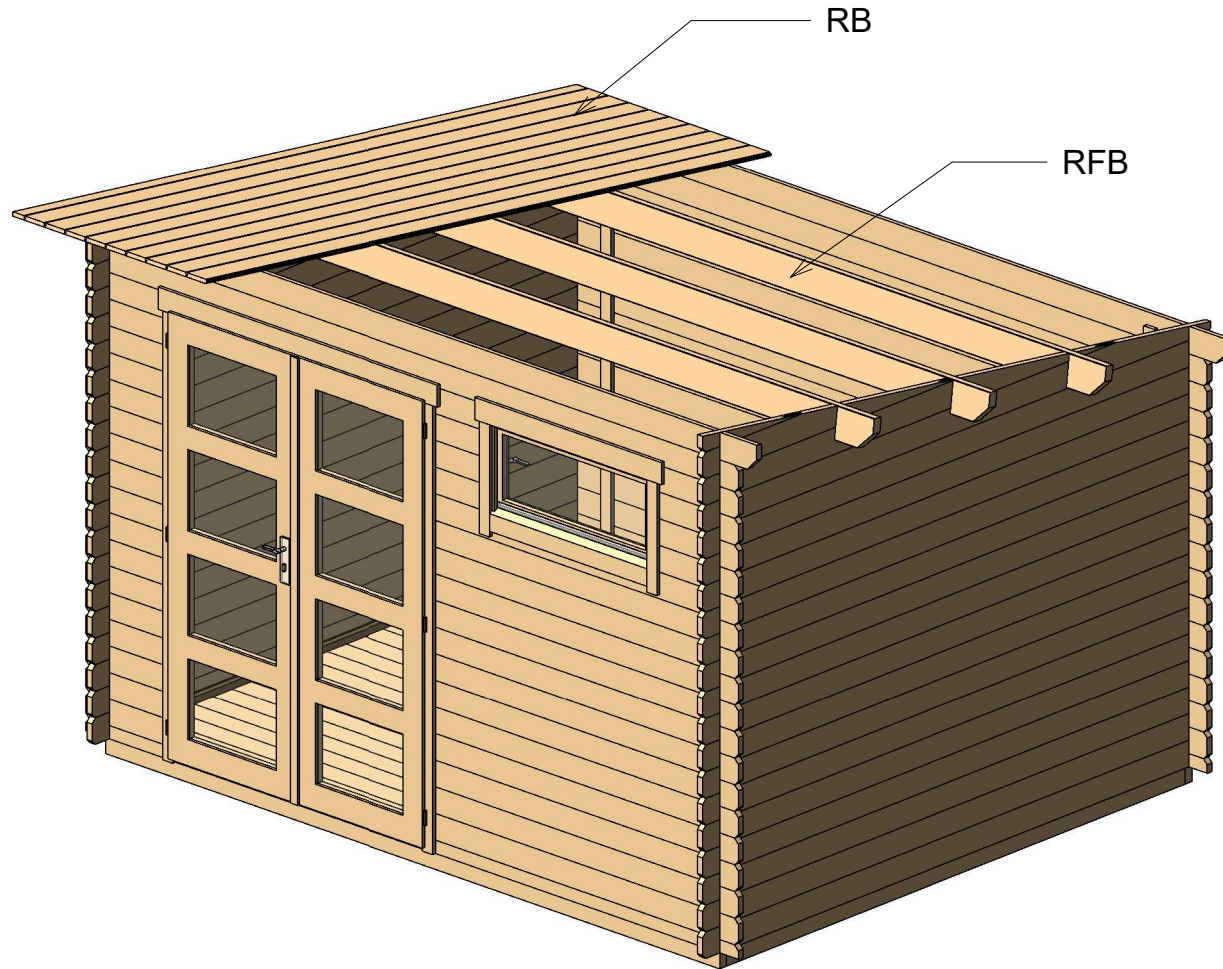
Roof 1



Roof				
Mark	Type	Profile	Count	Length
RFB	Beam 40x143		3	147 3/4"
RB	18x110		35	129 3/4"

Nevada 1 1/8" (131 7/8" x 107 7/8")

Roof 2

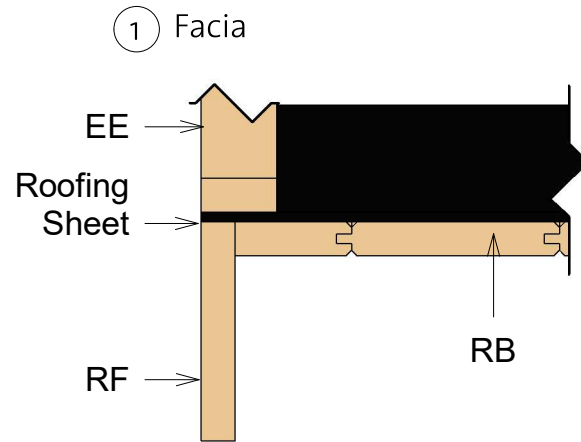
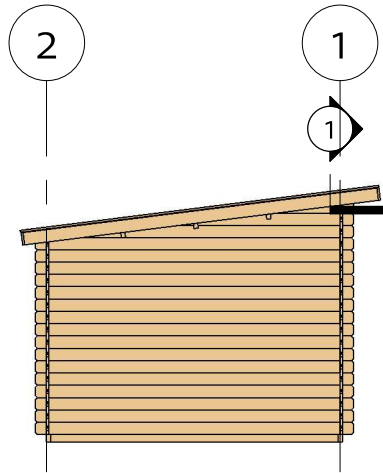

2 Roof Reinforcement

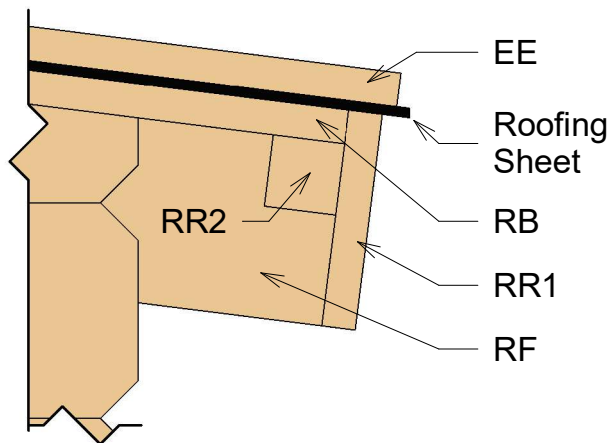
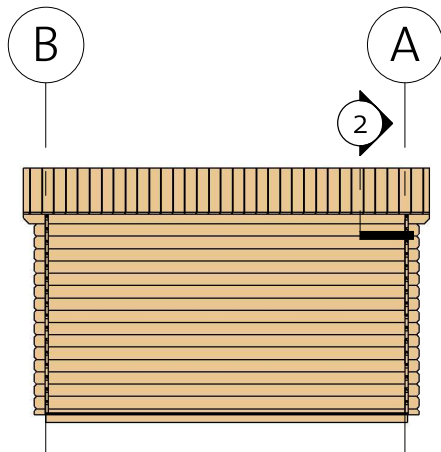

Fascia Schedule				
Mark	Type	Profile	Count	Length
EE	Eave Edging 18x40		2	131 1/2"
RF	Roof Fascia 18x115		2	129 3/4"
RR1	Roof reinforcement 18x115		2	149 7/16"
RR2	Roof reinforcement 38x38		2	147 3/4"

Nevada 1 1/8" (131 7/8" x 107 7/8")

Extras

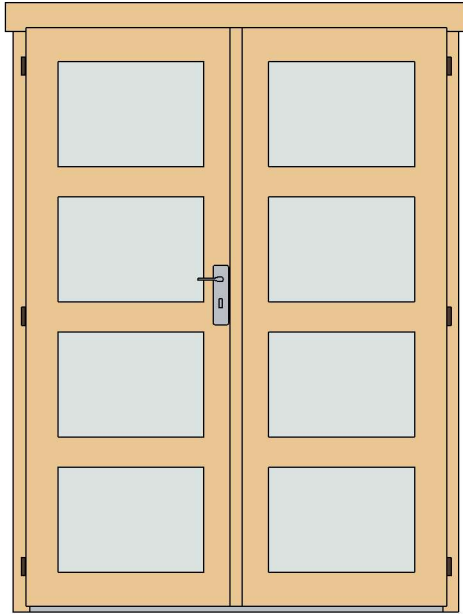

Door Schedule				
Model	Type	Width	Height	Count
BDD4L	Basic double door 4, four glass left	56 1/8"	76 15/16"	1

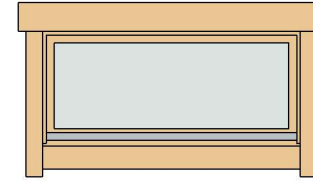

Window Schedule				
Model	Type	Width	Height	Count
BW2L	Basic window 2, full glass left	36"	16 9/16"	1

Fasteners & Extras		
Name	Comments	Count

Hitblock	11 13/16"-15 3/4"	
Bolts	M5/16" x 2 3/8"	12
Screws	3/16" x 2 3/4"	15
Nails	1/16" x 1 9/16"	30
Screws	1/4" x 5 1/2"	60
Screws	3/16" x 1 9/16"	70
Screws	3/16" x 2"	500



Type	Count	Length
Windboard 18x40	4	86 5/8"



190418

Nevada 1 1/8" (131 7/8"x107 7/8")

List of all items 1

Impregnated foundation beams

Mark	Type	Profile	Count	Length
------	------	---------	-------	--------

IFB1	IFB 40x70		10	104 1/2"
IFB2	IFB 40x70		2	131 5/8"

Floor Schedule



Mark	Type	Profile	Count	Length
------	------	---------	-------	--------

FB	FB 18x110		26	129 3/4"
----	-----------	---	----	-------------

BB1	BB 20x40		2	110 1/4"
BB2	BB 20x40		2	133 7/8"





Roof

Mark	Type	Profile	Count	Length
------	------	---------	-------	--------

RFB	Beam 40x143		3	147 3/4"
RB	18x110		35	129 3/4"

Fascia Schedule

Mark	Type	Profile	Count	Length
------	------	---------	-------	--------

EE	Eave Edging 18x40		2	131 1/2"
RF	Roof Fascia 18x115		2	129 3/4"
RR1	Roof reinforcement 18x115		2	149 7/16"
RR2	Roof reinforcement 38x38		2	147 3/4"

Nevada 1 1/8" (131 7/8"x107 7/8")

List of all items 2

Wall 1			
Mark	Profile	Count	Cut Length

1BL 1	28x57	1	17 11/16"
1BL 2	28x57	1	65 1/2"
1LG 1	28x114	4	11 9/16"
1LG 2	28x114	21	17 11/16"
1LG 3	28x114	13	65 1/2"
1LG 4	28x114	1	139 7/8"
1TL 1	28x118	1	147 3/4"

Wall 2			
Mark	Profile	Count	Cut Length

2BL 1	28x57	1	139 7/8"
2LG 1	28x114	15	139 7/8"
2TL 1	28x118	1	147 3/4"

Wall A			
Mark	Profile	Count	Cut Length

ALG 1	28x114	1	22 15/16"
ALG 2	28x114	1	57 3/16"
ALG 3	28x114	1	94 1/4"
ALG 4	28x114	1	115 7/8"
ALG 5	28x114	16	115 7/8"

Wall B			
Mark	Profile	Count	Cut Length

BLG 1	28x114	1	22 15/16"
BLG 2	28x114	1	57 3/16"
BLG 3	28x114	1	94 1/4"
BLG 4	28x114	1	115 7/8"
BLG 5	28x114	16	115 7/8"

Log Profiles	
Profile	Profile

28x57	
-------	---

Log Profiles	
Profile	Profile

28x114	
28x118	