

Ohio 28 (70 7/8" x 70 7/8")

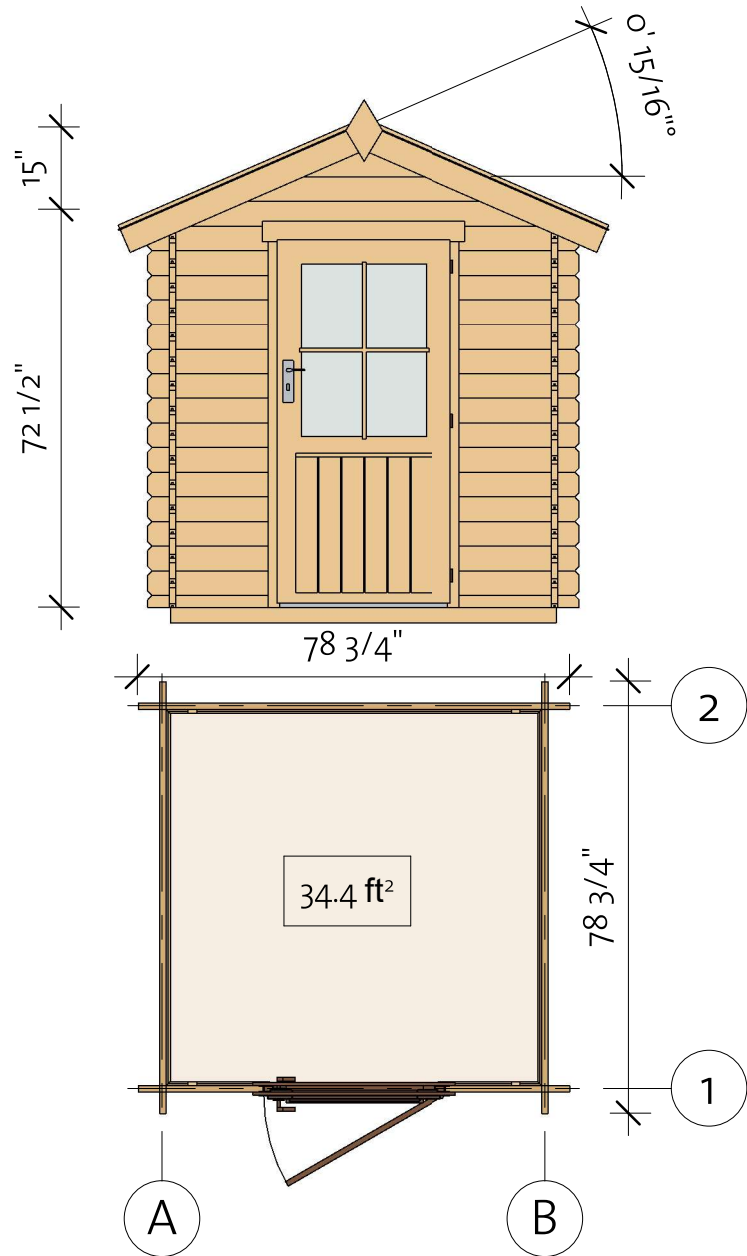

Ohio 28 (70 7/8" x 70 7/8")

Foundation

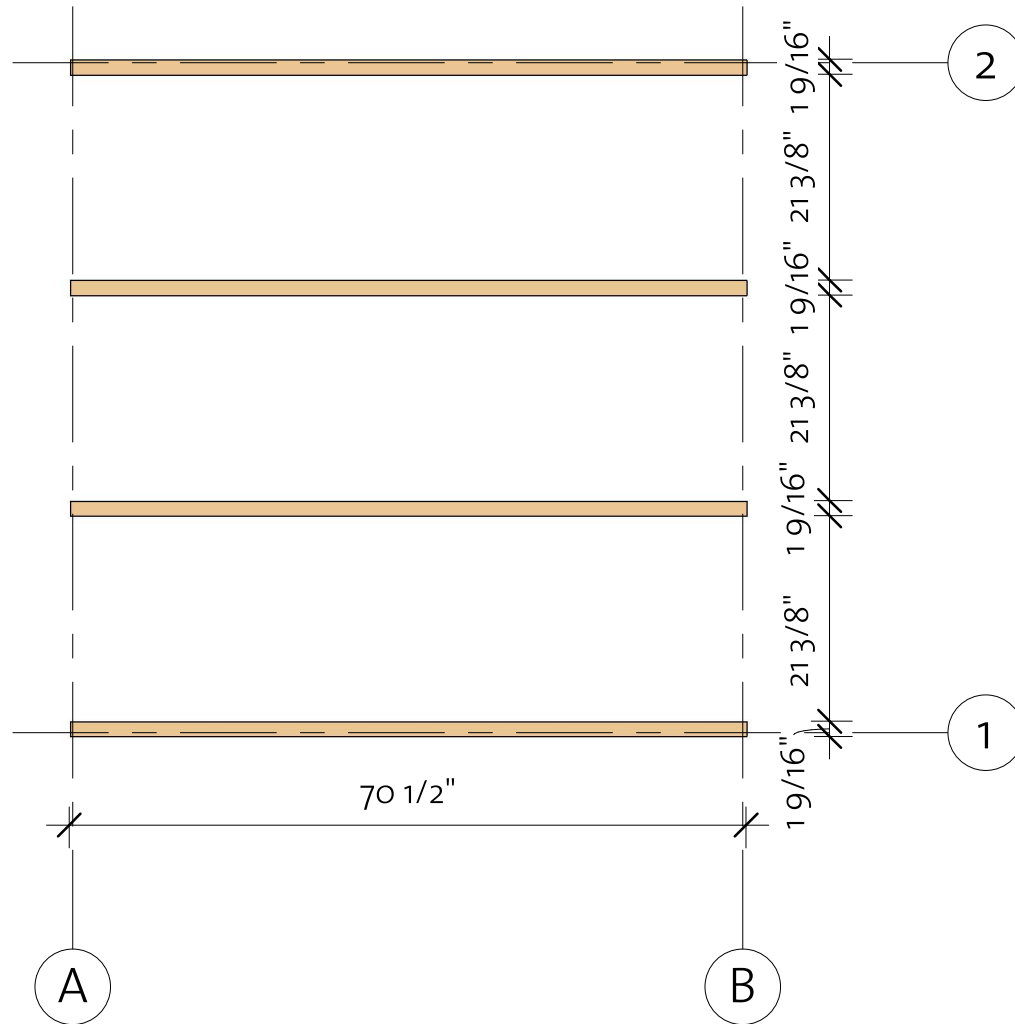

Impregnated foundation beams				
Mark	Type	Profile	Length	Count

IFB	IFB 4ox7o		70 1/2"	4
-----	-----------	-------------------------------------------------------------------------------------	---------	---



Ohio 28 (70 7/8" x 70 7/8")

Floor Plan

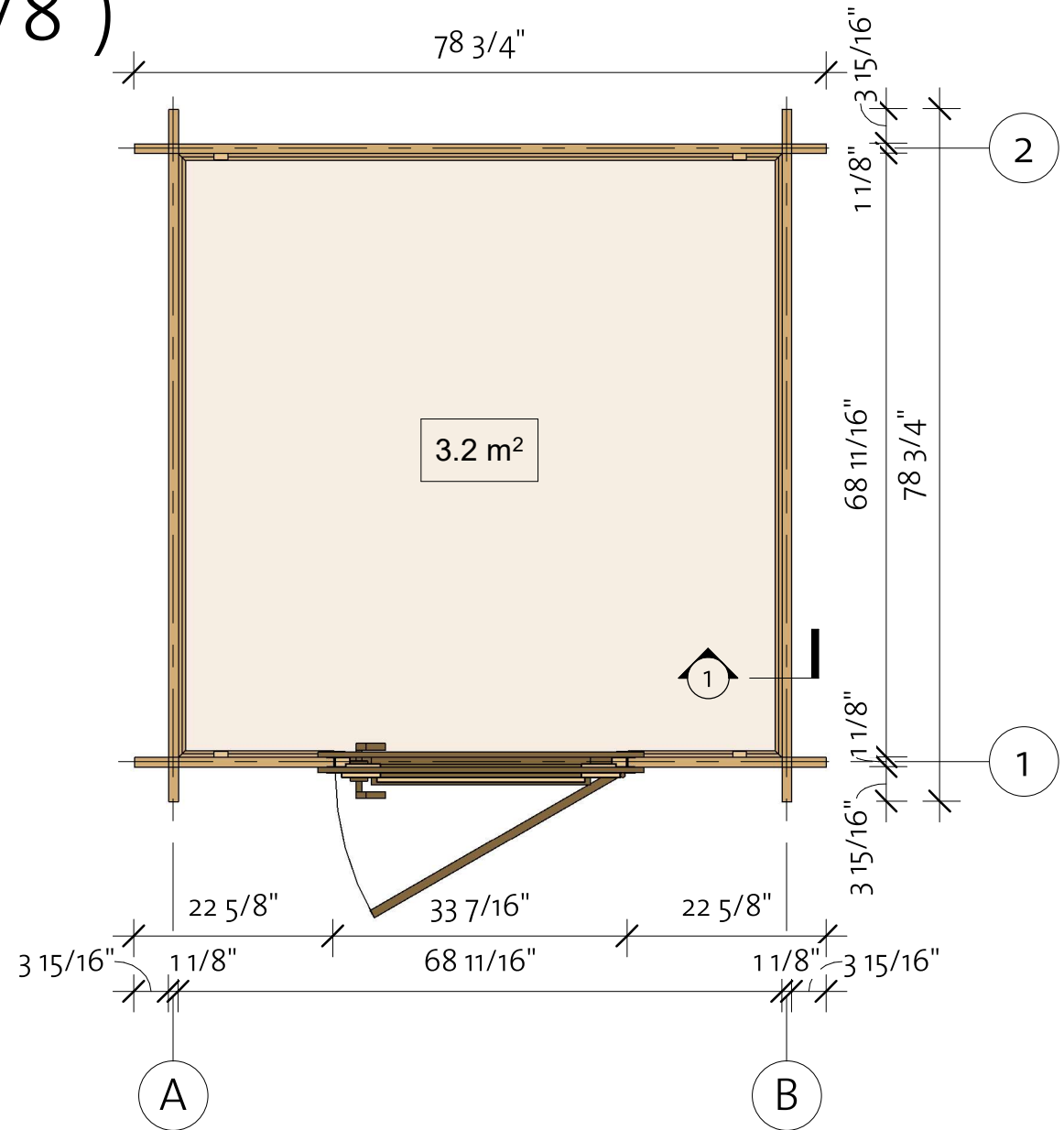
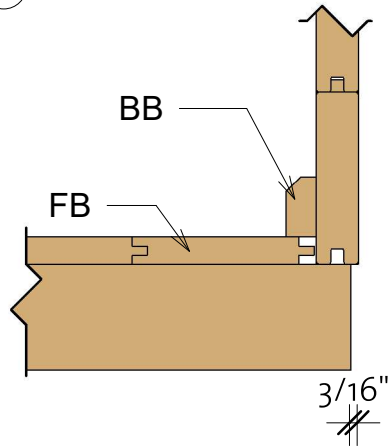
① Baseboard



Floor Schedule

Mark	Type	Profile	Count	Length
FB	FB 18x110		17	68 1/2"
BB	BB 20x40		4	70 7/8"

Ohio 28 (70 7/8" x 70 7/8")

Wall 1

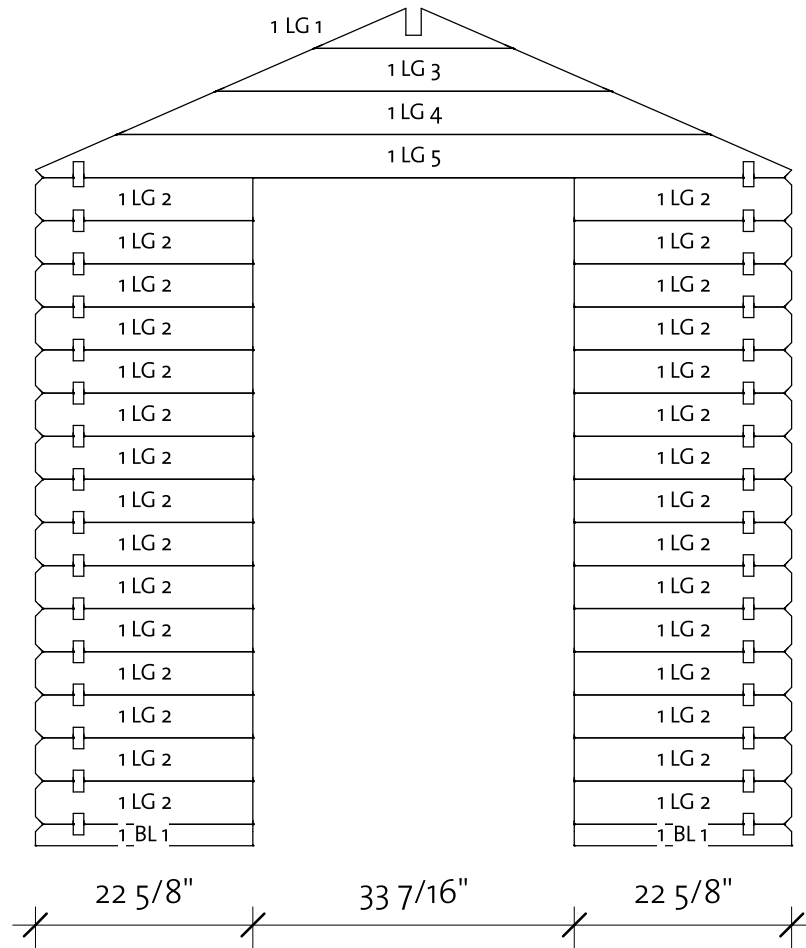
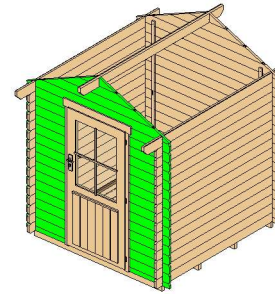



Wall 1			
Mark	Profile	Count	Cut Length

1BL 1	28x57	2	22 5/8"
1LG 1 *	28x114	1	20 11/16"
1LG 2	28x114	30	22 5/8"
1LG 3 *	28x114	1	41 1/4"
1LG 4 *	28x114	1	61 13/16"
1LG 5 *	28x114	1	78 3/4"

* Gable - delivered premounted

Log Profile Wall 1	
Profile	Profile

28x57	
28x114	

Ohio 28 (70 7/8" x 70 7/8")

Wall 2

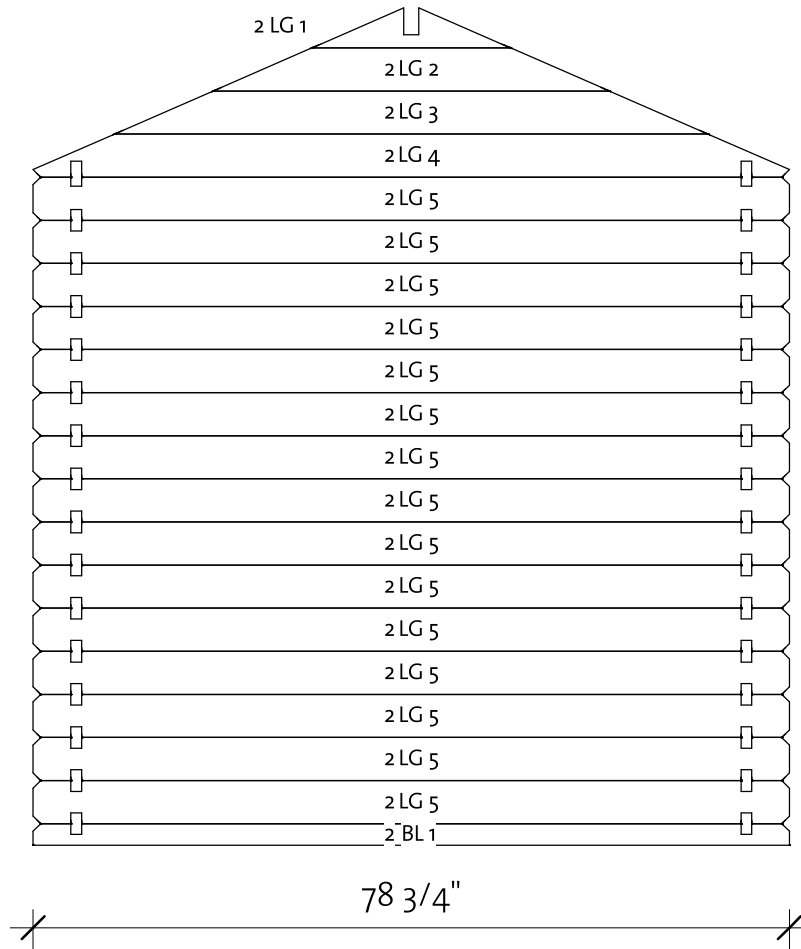
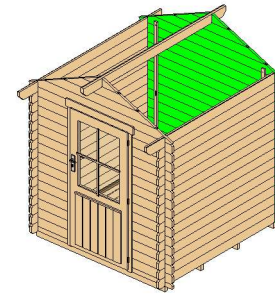



Wall 2			
Mark	Profile	Count	Cut Length

2BL 1	28x57	1	78 3/4"
2LG 1*	28x114	1	20 11/16"
2LG 2*	28x114	1	41 1/4"
2LG 3*	28x114	1	61 13/16"
2LG 4*	28x114	1	78 3/4"
2LG 5	28x114	15	78 3/4"

* Gable - delivered premounted

Log Profile Wall 2	
Profile	Profile

28x57	
28x114	

Ohio 28 (70 7/8" x 70 7/8")

Wall A

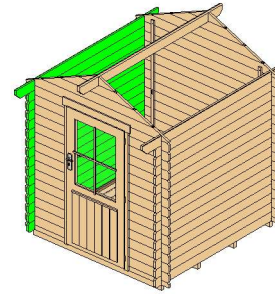

Wall A			
Mark	Profile	Count	Cut Length

ALG 1	28x114	15	78 3/4"
ATL 1	28x123	1	90 9/16"

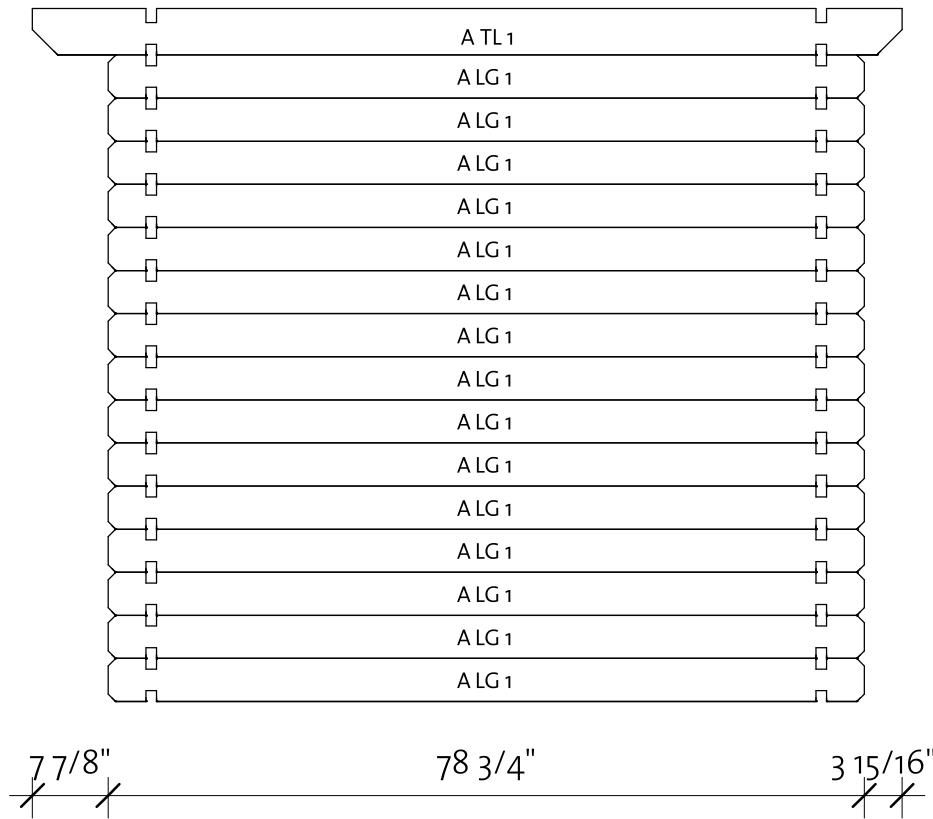

Log Profile Wall A	
Profile	Profile

28x114	
28x123	

Ohio 28 (70 7/8" x 70 7/8")

Wall B

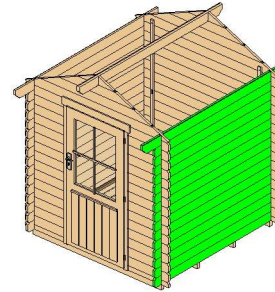

Wall B			
Mark	Profile	Count	Cut Length

BLG 1	28x114	15	78 3/4"
BTL 1	28x123	1	90 9/16"

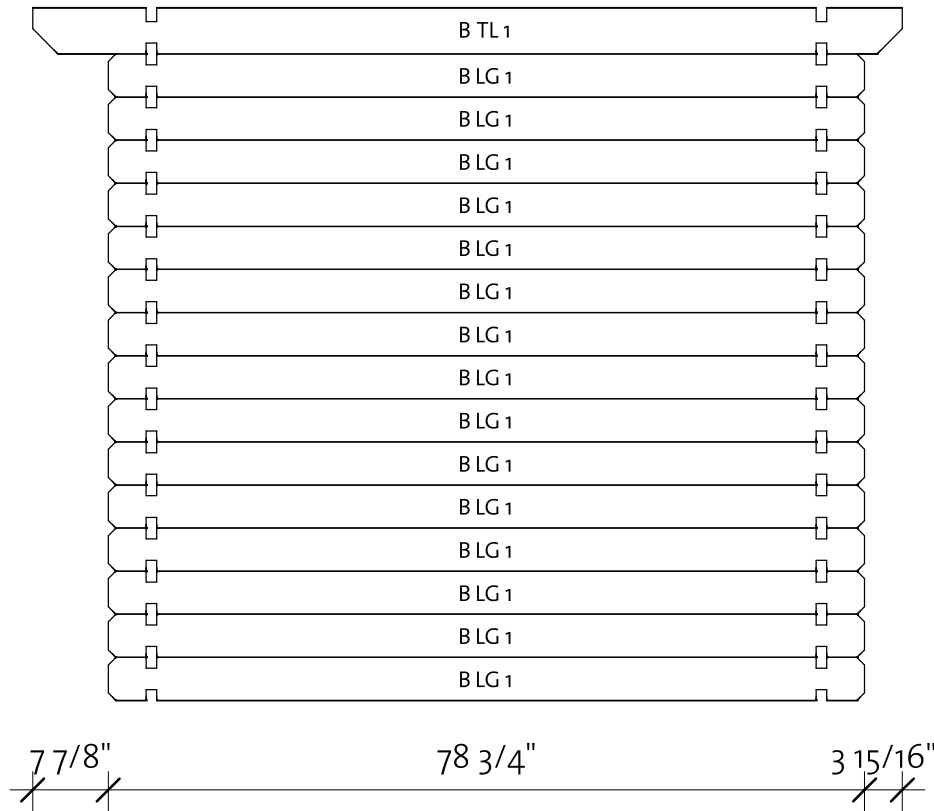



Log Profile Wall B	
Profile	Profile

28x114	
28x123	

Ohio 28 (70 7/8" x 70 7/8")

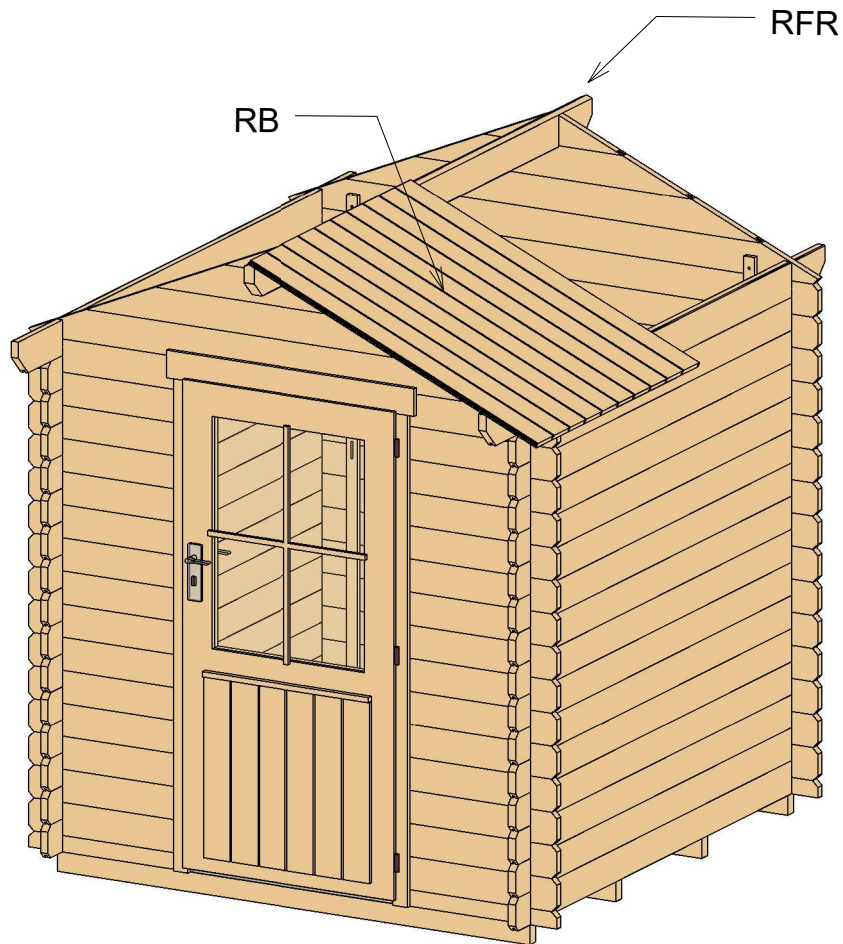
Roof 1



Roof				
Mark	Type	Profile	Count	Length
RFR	Ridge 40x120		1	90 9/16"
RB	RoofBoard 18x110		44	46 7/8"

Ohio 28 (70 7/8" x 70 7/8")

Roof 2

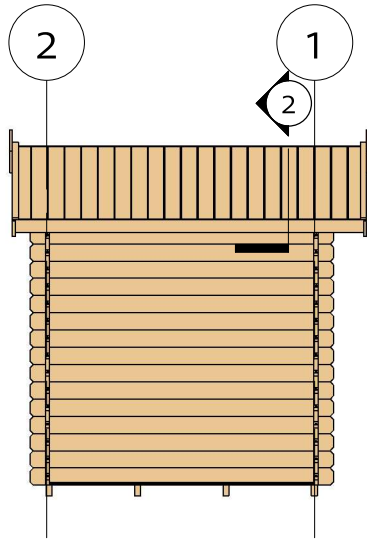

② Facia

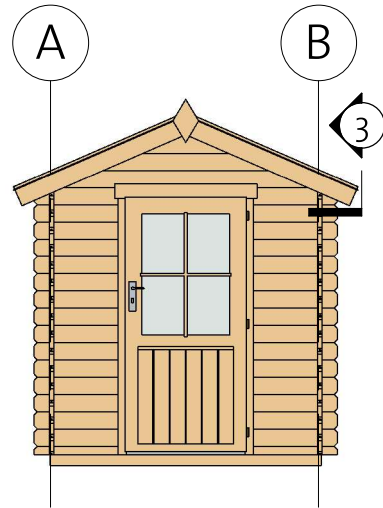
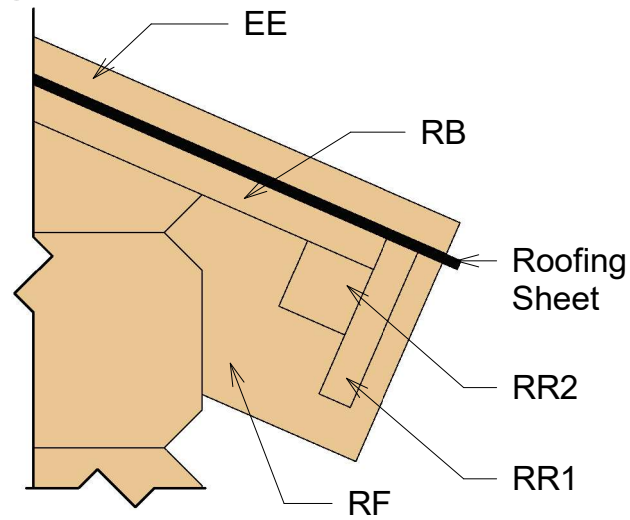

③ Roof Reinforcement

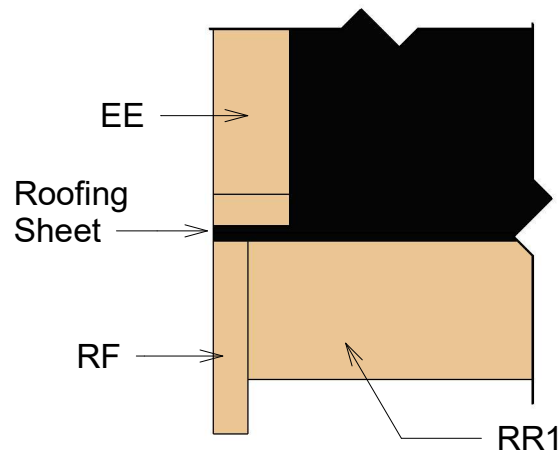

Fascia Schedule

Mark	Type	Profile	Count	Length
EE	Eave Edging 18x40		4	48 7/16"
RF	Roof Fascia 18x115		4	48 7/16"
RR1	Roof reinforcement 18x90		2	90 9/16"
RR2	Roof reinforcement 38x38		2	90 9/16"

Ohio 28 (70 7/8" x 70 7/8")

Extras



Door Schedule				
Model	Type	Width	Height	Count
BD1R	Basic door 1 right	33 1/16"	68 1/8"	1
DCB4	Door crossbar 4	--	--	1

Fasteners/Extras		
Name	Comments	Count
Hitblock	11" -15 3/4" mm	4
Screws	o 3/16" x 2 3/4"	10
Bolts	Mo 5/16" x 2 3/8"	12
Nails	o 1/16" x 1 9/16"	20
Screws	o 1/4" x 5 1/2"	25
Screws	o 3/16" x 1 9/16"	60
Screws	o 3/16" x 1 15/16"	190



Type	Count	Length
Windboard 18x40	4	69 11/16"

Type	Count
Romb	1/16"



Ohio 28 (70 7/8"x70 7/8")

List of all items 1

Impregnated foundation beams				
Mark	Type	Profile	Length	Count



IFB	IFB 40x70		70 1/2"	4
-----	-----------	-----------------------------------------------------------------------------------	---------	---

Floor Schedule				
Mark	Type	Profile	Count	Length





FB	FB 18x110		17	68 1/2"
----	-----------	-------------------------------------------------------------------------------------	----	---------

BB	BB 20x40		4	70 7/8"
----	----------	-------------------------------------------------------------------------------------	---	---------

Roof				
Mark	Type	Profile	Count	Length

RFR	Ridge 40x120		1	90 9/16"
RB	RoofBoard 18x110		44	46 7/8"

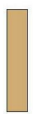
Fascia Schedule				
Mark	Type	Profile	Count	Length

EE	Eave Edging 18x40		4	48 7/16"
RF	Roof Fascia 18x115		4	48 7/16"
RR1	Roof reinforcement 18x90		2	90 9/16"
RR2	Roof reinforcement 38x38		2	90 9/16"

Ohio 28 (70 7/8"x70 7/8")

List of all items 2

Wall 1			
Mark	Profile	Count	Cut Length

1BL 1	28x57	2	22 5/8"
1LG 1 *	28x114	1	20 11/16"
1LG 2	28x114	30	22 5/8"
1LG 3 *	28x114	1	41 1/4"
1LG 4 *	28x114	1	61 13/16"
1LG 5 *	28x114	1	78 3/4"

* Gable - delivered premounted

Wall 2			
Mark	Profile	Count	Cut Length

2BL 1	28x57	1	78 3/4"
2LG 1 *	28x114	1	20 11/16"
2LG 2 *	28x114	1	41 1/4"
2LG 3 *	28x114	1	61 13/16"
2LG 4 *	28x114	1	78 3/4"
2LG 5	28x114	15	78 3/4"



Wall A			
Mark	Profile	Count	Cut Length

ALG 1	28x114	15	78 3/4"
ATL 1	28x123	1	90 9/16"

Wall B			
Mark	Profile	Count	Cut Length

BLG 1	28x114	15	78 3/4"
BTL 1	28x123	1	90 9/16"

Log Profiles	
Profile	Profile

28x57	
28x114	

Log Profiles	
Profile	Profile

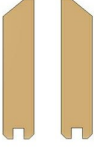
28x123	
--------	---------------------------------------------------------------------------------------