

Ontario Bunkie 160 40 (120 1/8"x192 1/8")

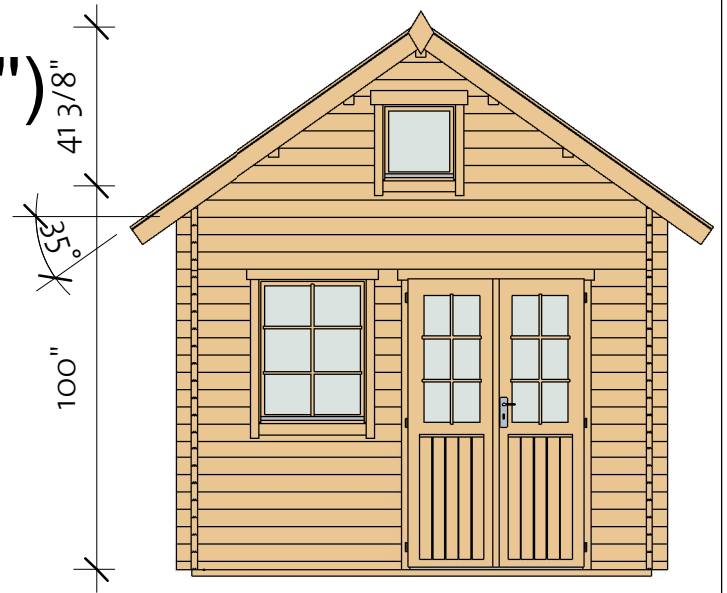

Ontario Bunkie 160 40 (120 1/8"x192 1/8")

Foundation

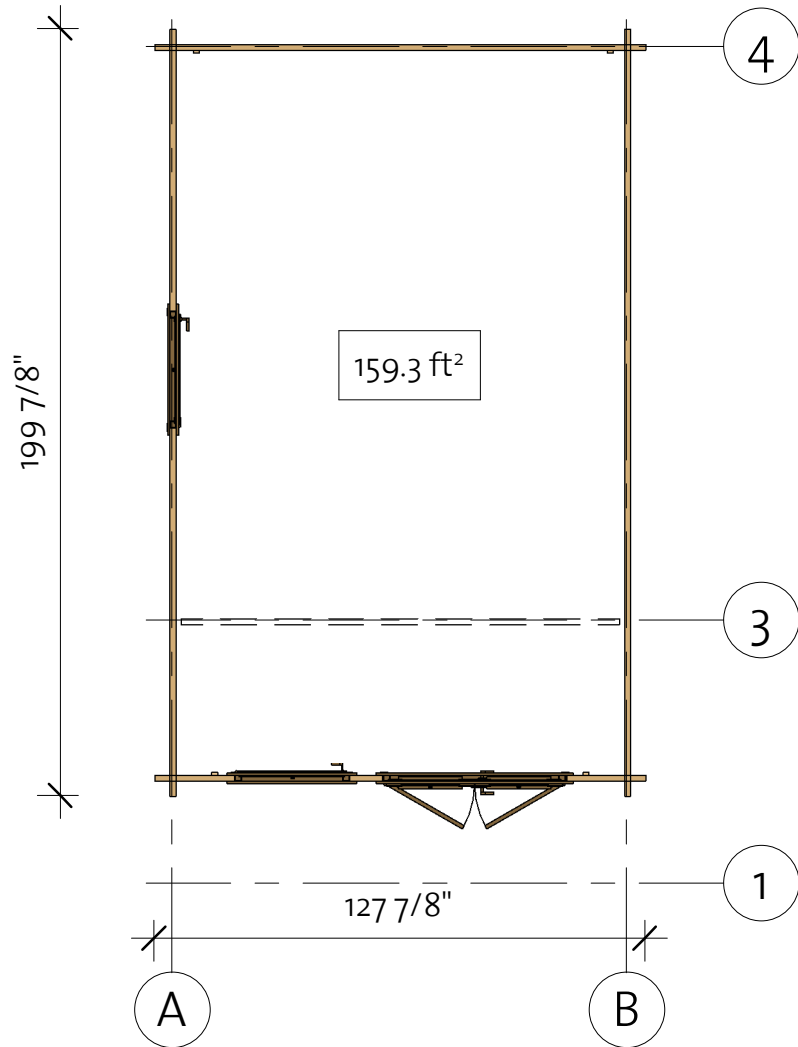
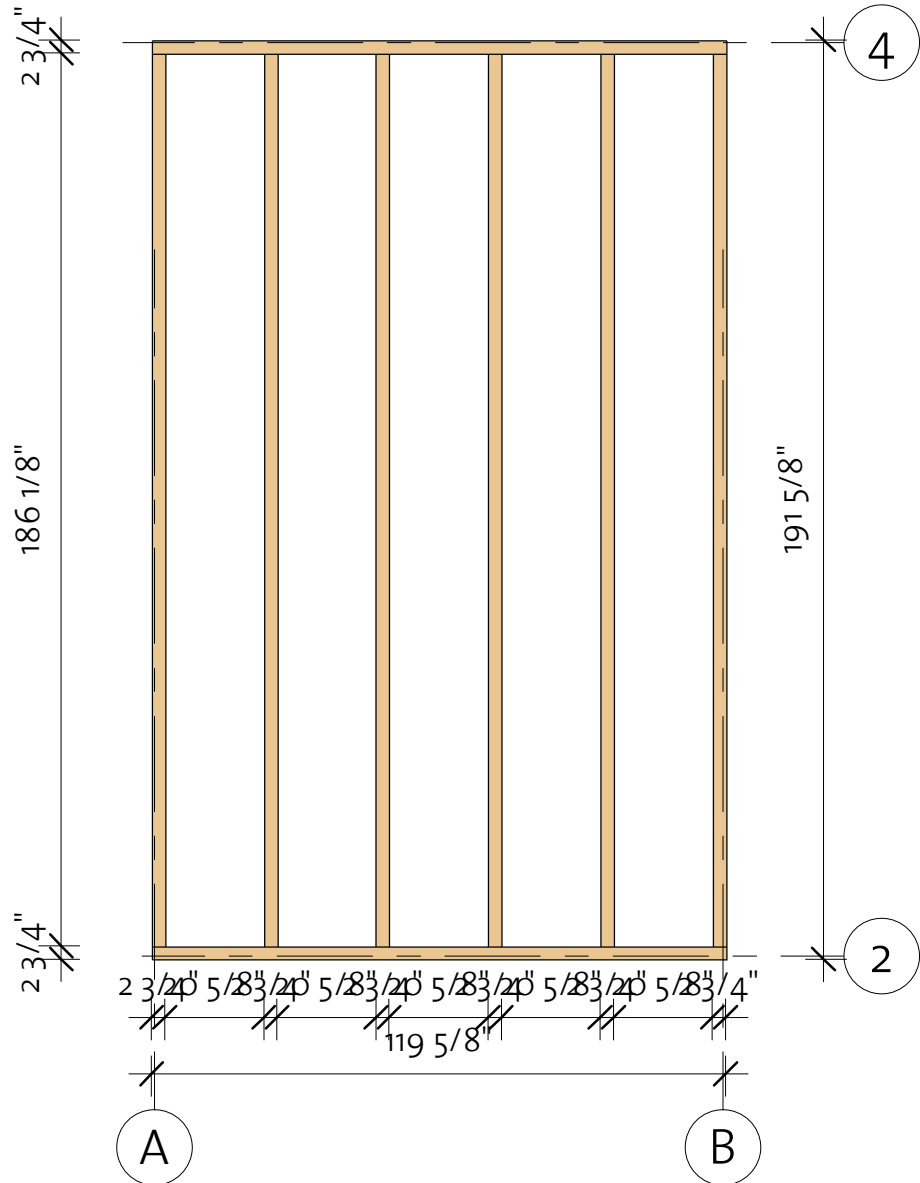

Impregnated foundation beams				
Mark	Type	Profile	Count	Length

IFB1	IFB 70x40		6	186 1/8"
IFB2	IFB 70x40		2	119 5/8"



Ontario Bunkie 160 40 (120 1/8"x192 1/8")

Floor Plan

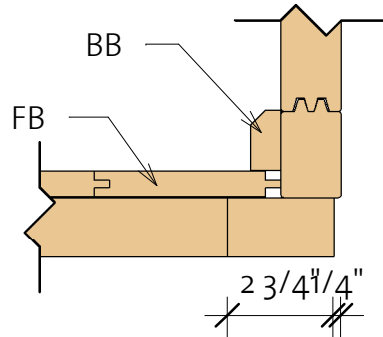
① Baseboard



Floor Schedule				
Mark	Type	Profile	Count	Length

FB1	FB 17x114		44	116 5/8"
FB2	FB 17x114		27	72 7/8"

BB1	BB 20x40		2	192 7/8"
BB2	BB 20x40		4	122"

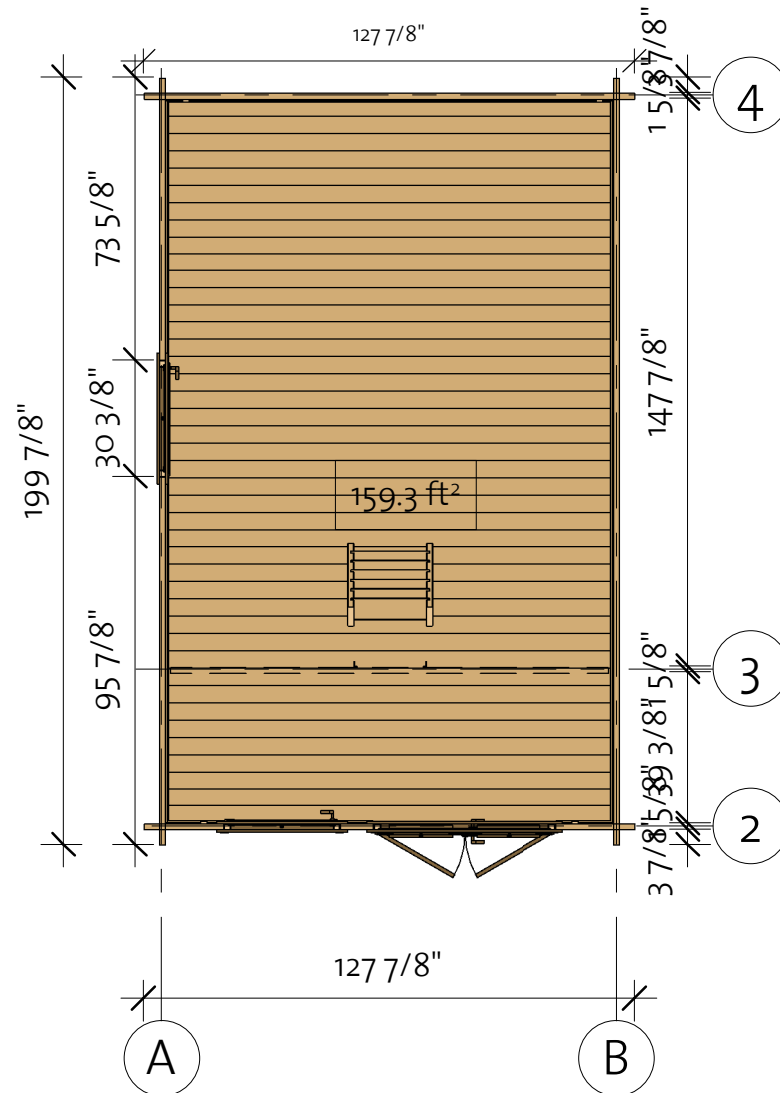

Ontario Bunkie 160 40 (120 1/8"x192 1/8")

Wall 1

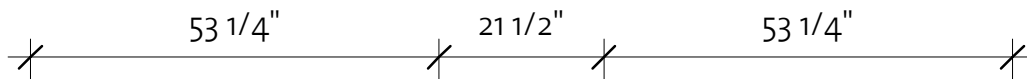
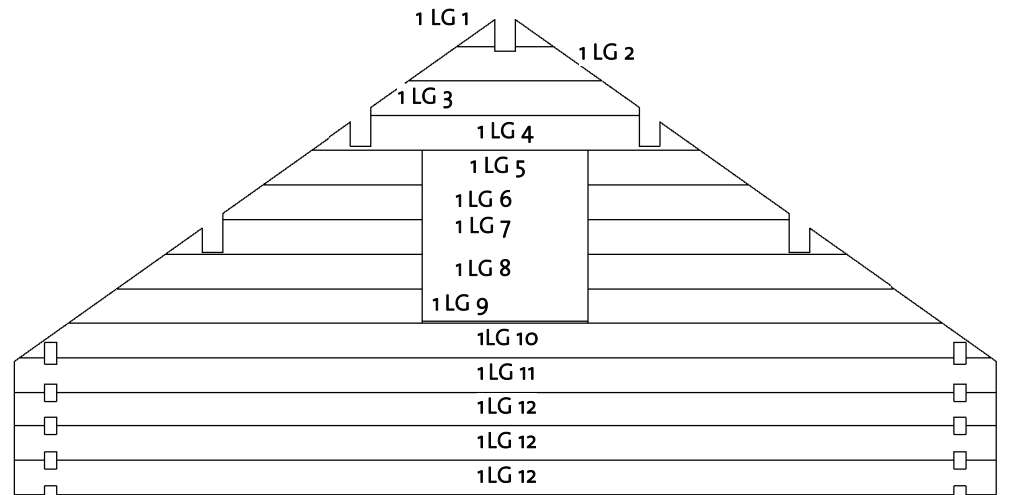
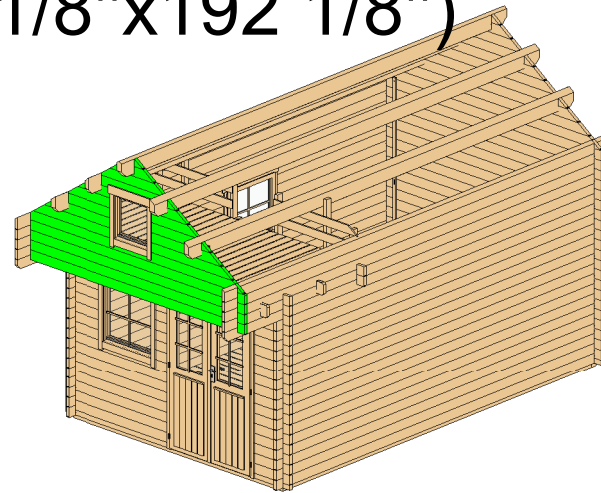

Wall 1			
Mark	Profile	Count	Cut Length

1LG 1 *	40X114	1	12 1/2"
1LG 2 *	40X114	1	25 1/8"
1LG 3 *	40X114	1	34 3/4"
1LG 4 *	40X114	1	50 1/2"
1LG 5 *	40X114	2	20 7/8"
1LG 6 *	40X114	2	26 1/8"
1LG 7 *	40X114	2	33 5/8"
1LG 8 *	40X114	2	39 7/8"
1LG 9 *	40X114	2	46 1/4"
1LG 10	40X114	1	126 5/8"
1LG 11	40X114	1	127 7/8"
1LG 12	40X114	3	127 7/8"

* Gable - delivered premounted

Log Profile Wall 1	
Profile	Profile

40X114	
--------	--

Ontario Bunkie 160 40 (120 1/8"x192 1/8")

Wall 2

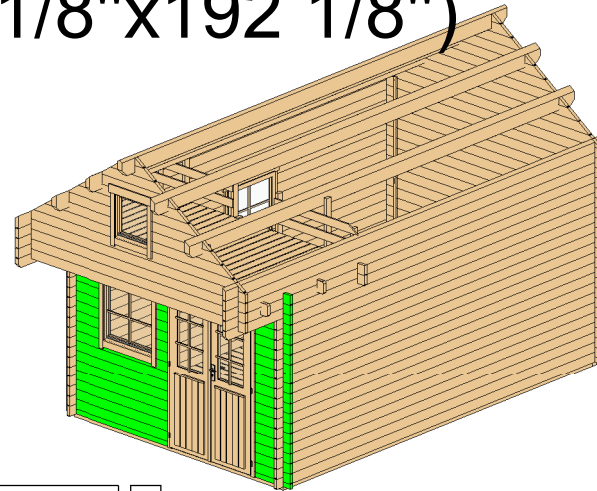

Wall 2			
Mark	Profile	Count	Cut Length

2BL 1	40X57	1	20 5/8"
2BL 2	40X57	1	59 5/8"
2LG 1	40X114	9	8 5/8"
2LG 2	40X114	26	20 5/8"
2LG 3	40X114	8	59 5/8"
2LG 4	40X114	1	127 7/8"
2LG 5	40X114	1	127 7/8"

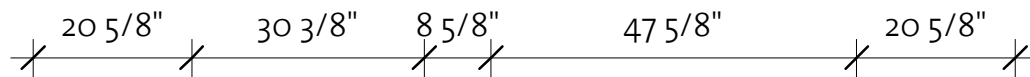
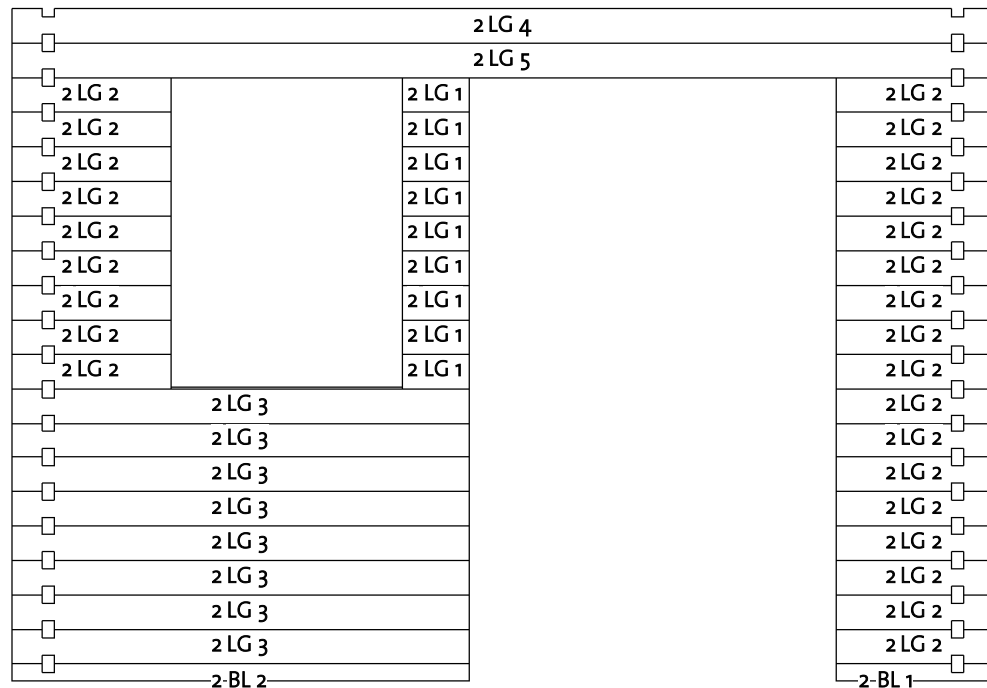

Log Profile Wall 2	
Profile	Profile

40X57	
40X114	
40X114	

Ontario Bunkie 160 40 (120 1/8"x192 1/8")

Wall 3

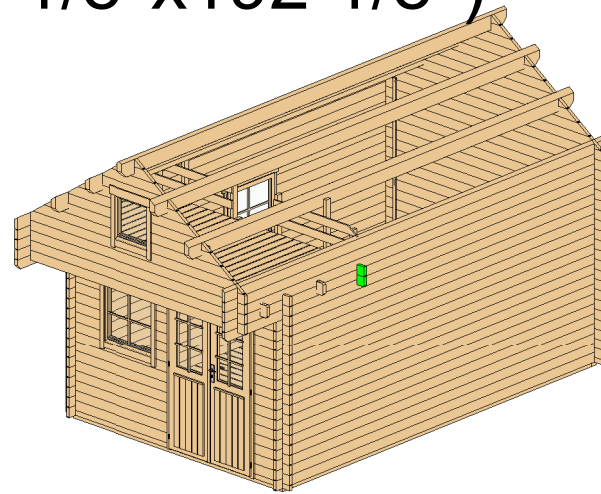

Wall 3			
Mark	Profile	Count	Cut Length

3LG 1	4OX114	1	127 7/8"
3LG 2	4OX114	1	127 7/8"

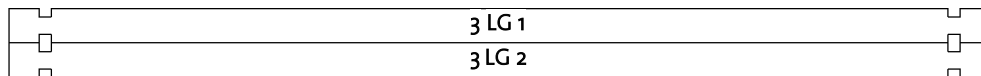

Log Profile Wall 3	
Profile	Profile

4OX114	
4OX114	

Ontario Bunkie 160 40 (120 1/8"x192 1/8")

Wall 4

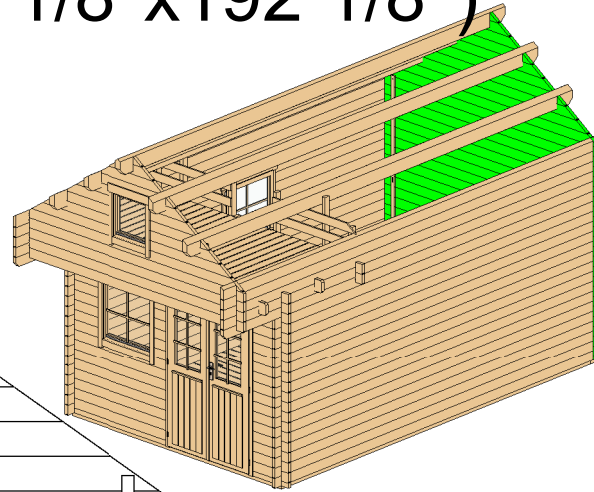
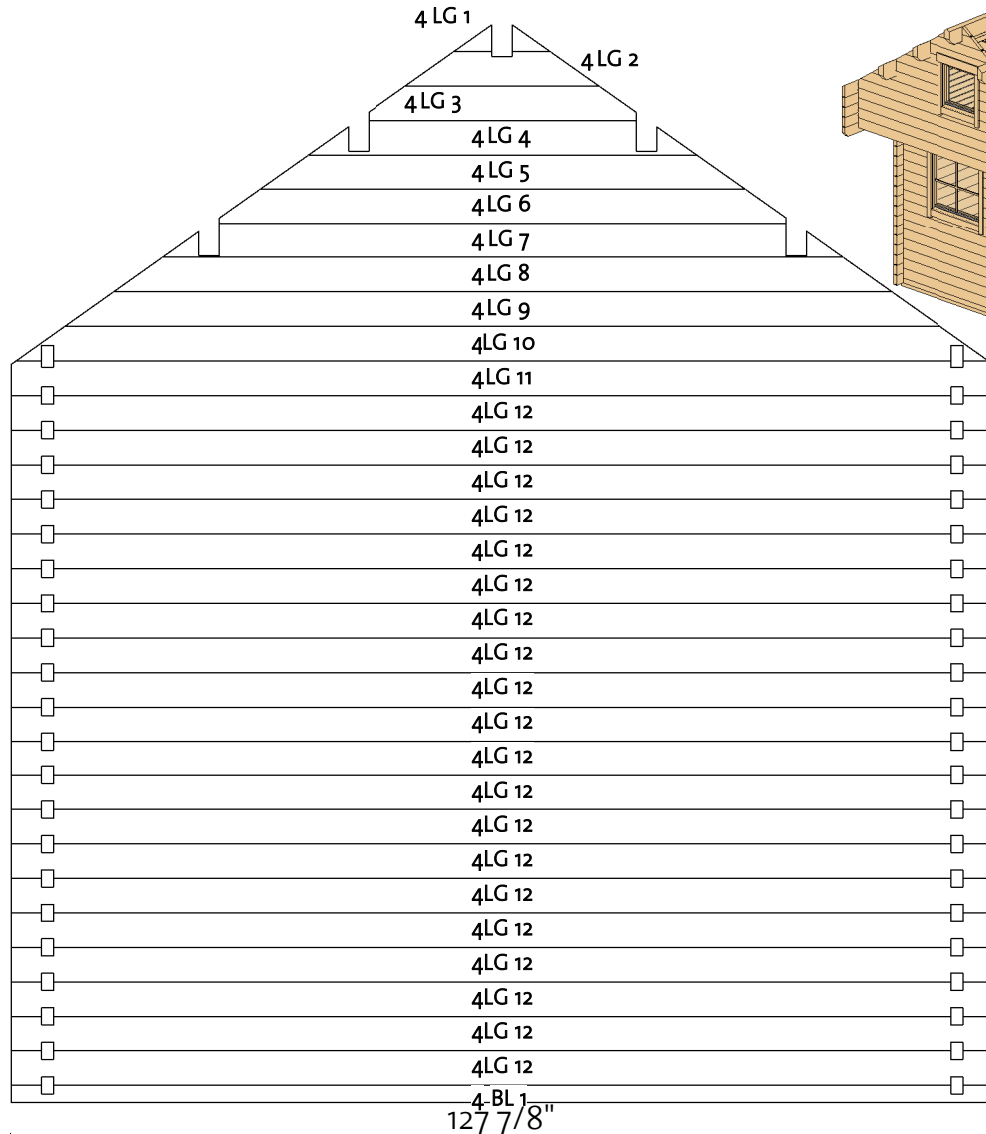

Wall 4			
Mark	Profile	Count	Cut Length

4BL 1	40X57	1	127 7/8"
4LG 1 *	40X114	1	12 1/2"
4LG 2 *	40X114	1	25 1/8"
4LG 3 *	40X114	1	34 3/4"
4LG 4 *	40X114	1	50 1/2"
4LG 5 *	40X114	1	63 1/4"
4LG 6 *	40X114	1	73 3/4"
4LG 7 *	40X114	1	88 5/8"
4LG 8 *	40X114	1	101 1/4"
4LG 9 *	40X114	1	114"
4LG 10 *	40X114	1	126 5/8"
4LG 11 *	40X114	1	127 7/8"
4LG 12	40X114	20	127 7/8"

* Gable - delivered premounted

Log Profile Wall 4	
Profile	Profile
40X57	

Log Profile Wall 4	
Profile	Profile
40X114	

Ontario Bunkie 160 40 (120 1/8"x192 1/8")

Wall A

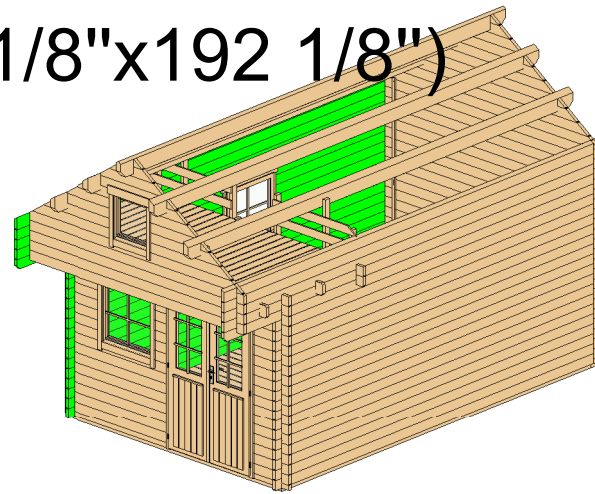

Wall A			
Mark	Profile	Count	Cut Length

ALG 1	40x114	9	73 5/8"
ALG 2	40x114	9	95 7/8"
ALG 3	40x114	8	199 7/8"
ALG 4	40x114	1	231 3/8"
ALG 5	40x114	1	235 1/4"
ALG 6	40x114	1	231 3/8"
ALG 7	40x114	1	231 3/8"
ATL 1	40x145	1	235 1/4"

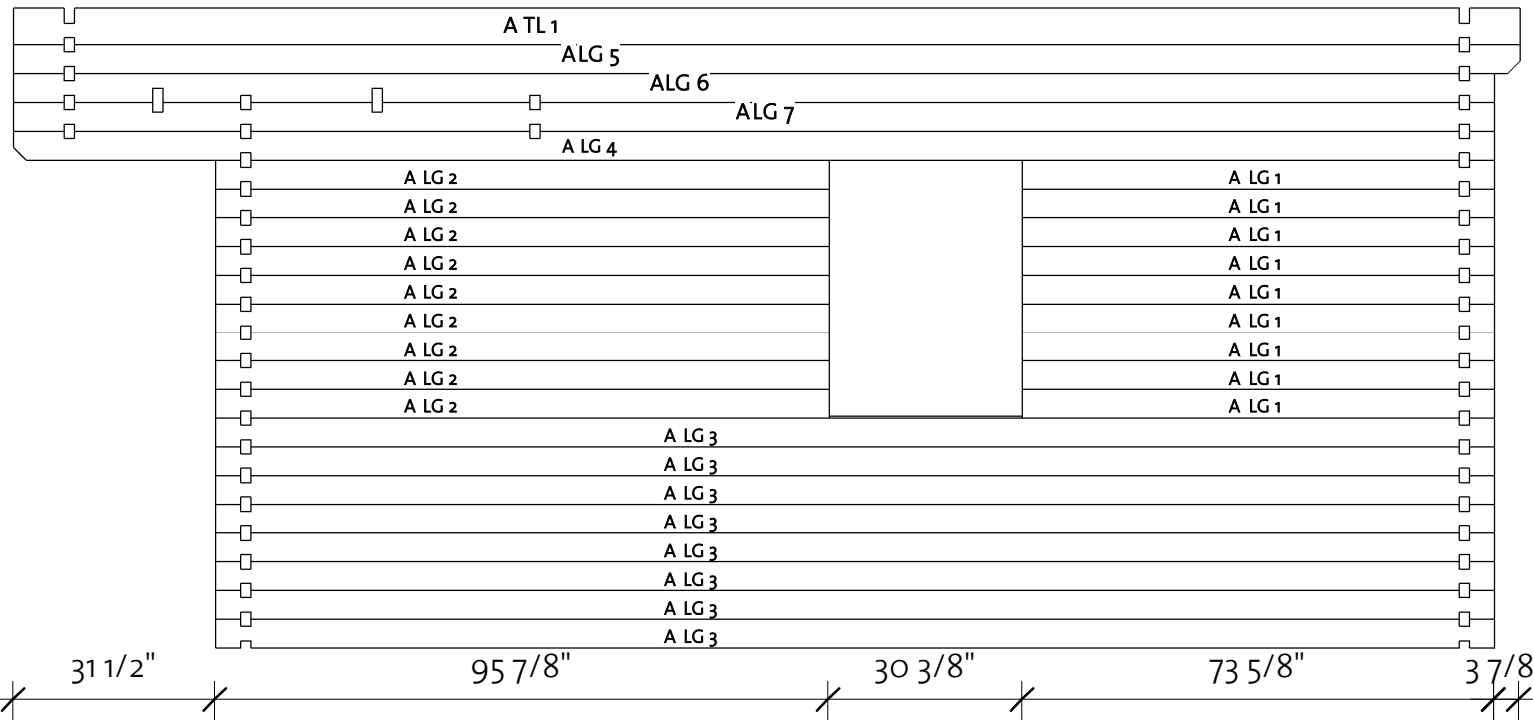

Log Profile Wall A	
Profile	Profile

40x114	
40x145	

92309165_231128

Ontario Bunkie 160 40 (120 1/8"x192 1/8")

Wall B

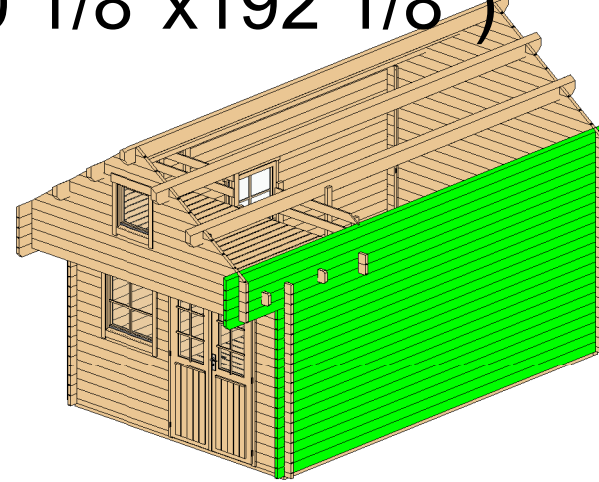

Wall B			
Mark	Profile	Count	Cut Length

BLG 1	40X114	17	199 7/8"
BLG 2	40X114	1	231 3/8"
BLG 3	40X114	1	235 1/4"
BLG 4	40X114	1	231 3/8"
BLG 5	40X114	1	231 3/8"
BTL 1	40X145	1	235 1/4"

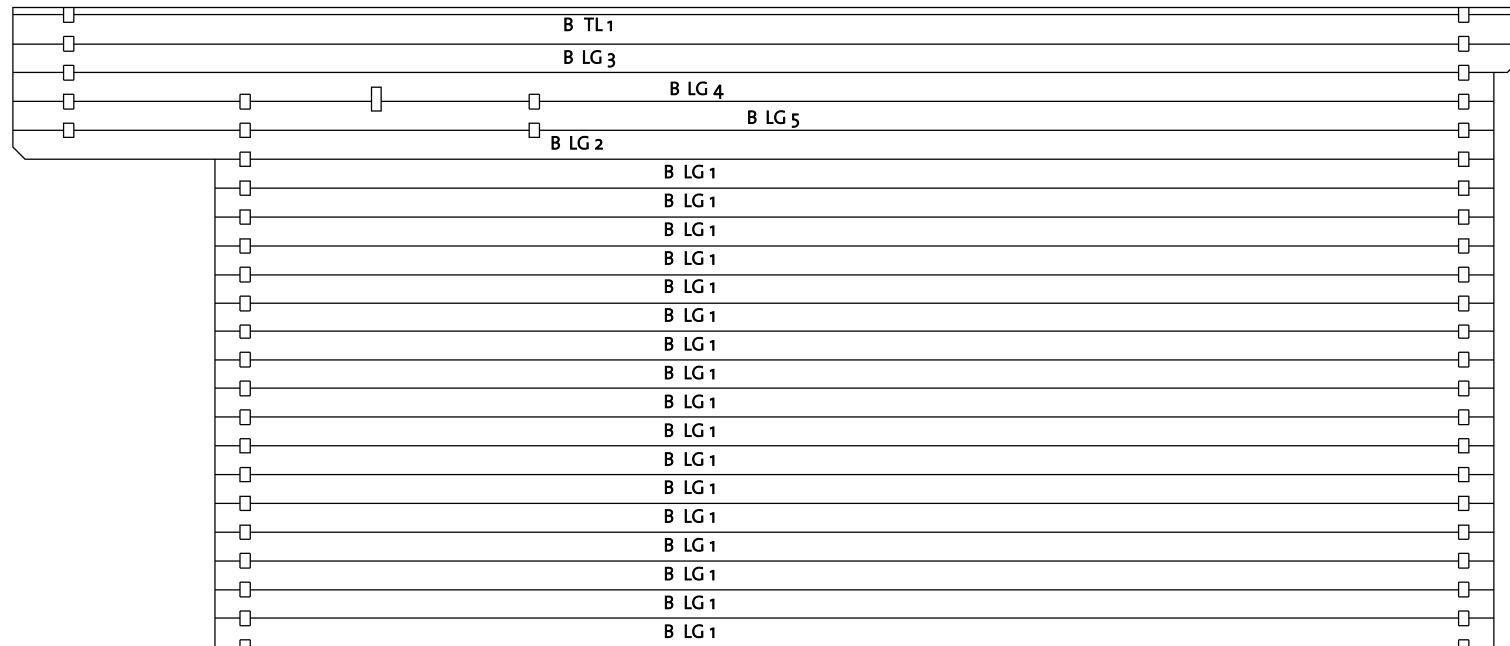

Log Profile Wall B	
Profile	Profile

40X114	
40X145	



92309165_231128

Ontario Bunkie 160 40 (120 1/8"x192 1/8")

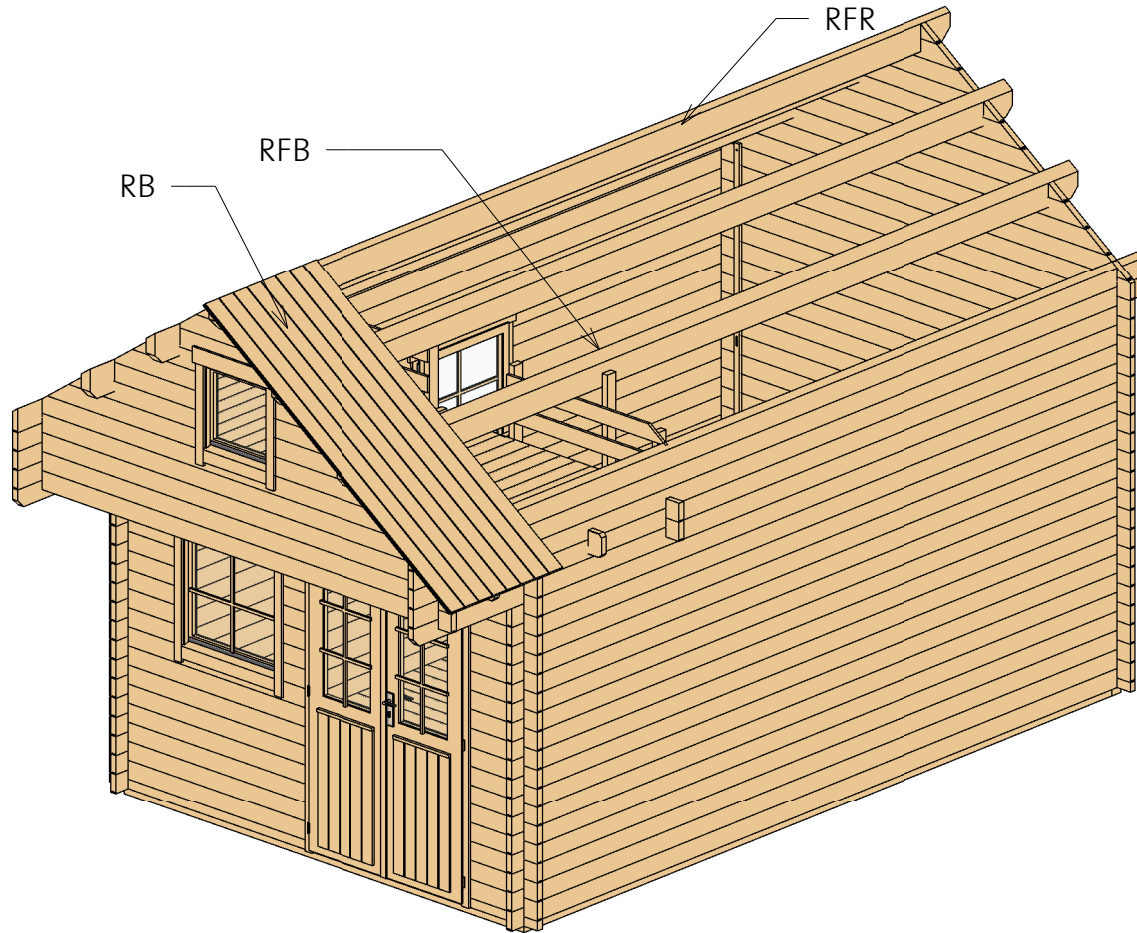
Roof 1

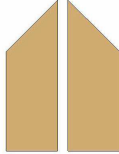

Roof				
Mark	Type	Profile	Count	Length

RFR	Ridge 68x193		1	235 1/4"
RFB	Beam 68x193		4	235 1/4"
RB	17x114		108	90 3/8"

Ontario Bunkie 160 40 (120 1/8"x192 1/8")

Roof 2

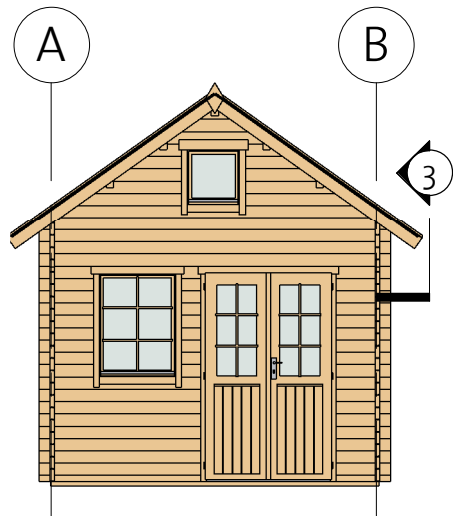
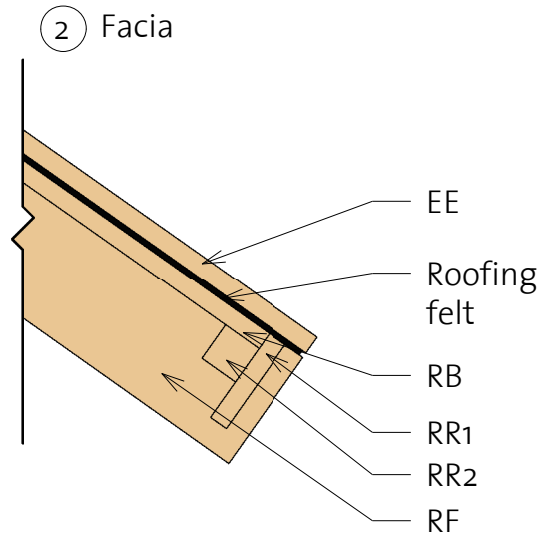
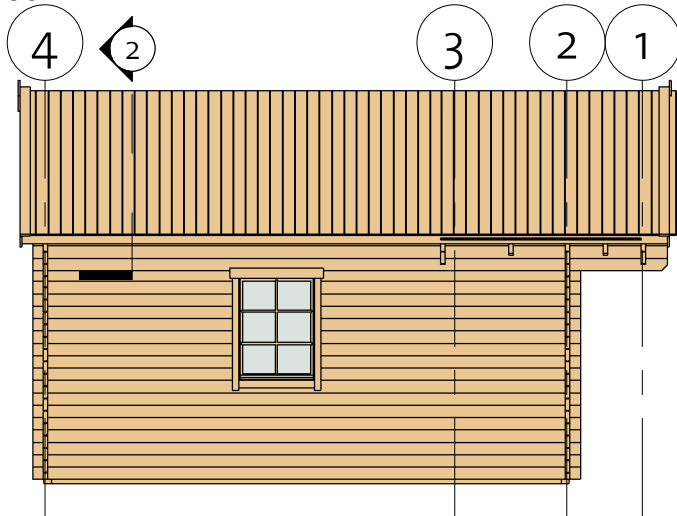

3) Roof Reinforcement

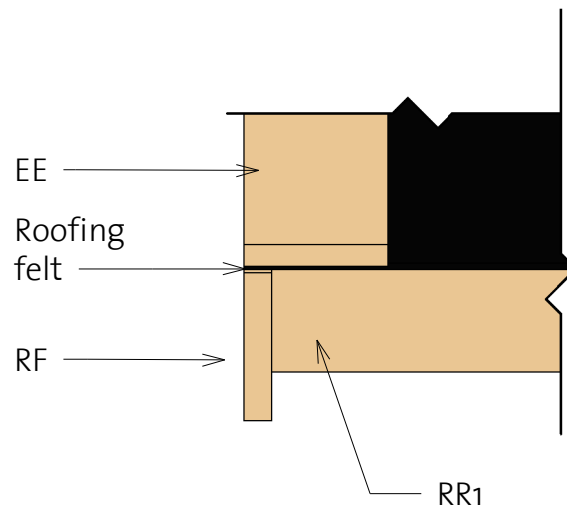

Fascia Schedule

Mark	Type	Profile	Count	Length
EE	Eave Edging 18x95		4	92 3/8"
RF	Roof Fascia 18x120		4	92 3/8"
RR1	Roof reinforcement 18x95		2	235 1/4"
RR2	Roof reinforcement 38x38		2	235 1/4"

Ontario Bunkie 160 40 (120 1/8"x192 1/8")

Extras

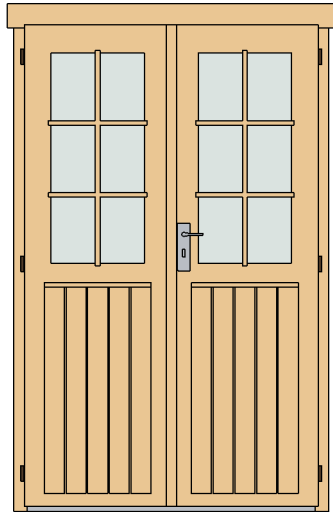

Door Schedule				
Model	Type	Width	Height	Count
CDD5R	Classic double door 5 right	47 1/4"	77"	1
DCB6-5	Door Crossbar 6-5	--	--	1/8"

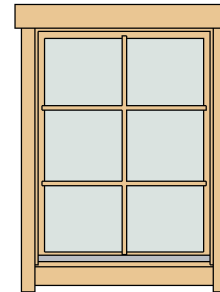

Window Schedule				
Model	Type	Width	Height	Count
CW1R	Classic window 1 right	30 1/8"	39"	2
CW12R	Classic window 12 right	21 1/4"	21 1/4"	1
WCB6	Windows Crossbar 6	--	--	2

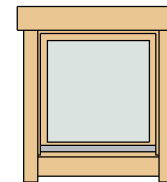

Fasteners & Extras		
Name	Type	Count

Hitblock	300-400 mm	
Ladder fittings		2
Screws	6,0x160	10
Bolts	M8 x 70	16
Nails	1,4 x 40	50
Screws	5,0 x 70	55
Screws	6,0 x 140	80
Screws	4,0 x 40	950

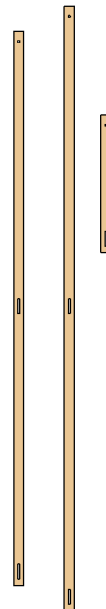

Type	Count	Length
Windboard1 18x40	2	94 1/2"
Windboard2 18x40	2	21 5/8"
Windboard3 18x40	2	86 5/8"

Family	Count
Romb	2





92309165_231128

Ontario Bunkie 160 40 (120 1/8"x192 1/8")

List of all items 1

Impregnated foundation beams



Mark	Type	Profile	Count	Length
------	------	---------	-------	--------

IFB1	IFB 70x40		6	186 1/8"
IFB2	IFB 70x40		2	119 5/8"

BB1	BB 20x40		2	192 7/8"
BB2	BB 20x40		4	122"



Floor Schedule

Mark	Type	Profile	Count	Length
------	------	---------	-------	--------

FB1	FB 17x114		44	116 5/8"
FB2	FB 17x114		27	72 7/8"



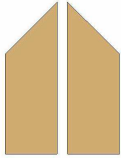

Roof

Mark	Type	Profile	Count	Length
------	------	---------	-------	--------

RFR	Ridge 68x193		1	235 1/4"
RFB	Beam 68x193		4	235 1/4"
RB	17x114		108	90 3/8"

Fascia Schedule

Mark	Type	Profile	Count	Length
------	------	---------	-------	--------

EE	Eave Edging 18x95		4	92 3/8"
RF	Roof Fascia 18x120		4	92 3/8"
RR1	Roof reinforcement 18x95		2	235 1/4"
RR2	Roof reinforcement 38x38		2	235 1/4"

Ontario Bunkie 160 40 (120 1/8"x192 1/8")

List of all items 2

Wall 1			
Mark	Profile	Count	Cut Length

1LG 1 *	40X114	1	12 1/2"
1LG 2 *	40X114	1	25 1/8"
1LG 3 *	40X114	1	34 3/4"
1LG 4 *	40X114	1	50 1/2"
1LG 5 *	40X114	2	20 7/8"
1LG 6 *	40X114	2	26 1/8"
1LG 7 *	40X114	2	33 5/8"
1LG 8 *	40X114	2	39 7/8"
1LG 9 *	40X114	2	46 1/4"
1LG 10 *	40X114	1	126 5/8"
1LG 11 *	40X114	1	127 7/8"
1LG 12	40X114	3	127 7/8"

Wall 4			
Mark	Profile	Count	Cut Length

4BL 1	40X57	1	127 7/8"
4LG 1 *	40X114	1	12 1/2"
4LG 2 *	40X114	1	25 1/8"
4LG 3 *	40X114	1	34 3/4"
4LG 4 *	40X114	1	50 1/2"
4LG 5 *	40X114	1	63 1/4"
4LG 6 *	40X114	1	73 3/4"
4LG 7 *	40X114	1	88 5/8"
4LG 8 *	40X114	1	101 1/4"
4LG 9 *	40X114	1	114"
4LG 10 *	40X114	1	126 5/8"
4LG 11 *	40X114	1	127 7/8"
4LG 12	40X114	20	127 7/8"

Wall 2			
Mark	Profile	Count	Cut Length



2BL 1	40X57	1	20 5/8"
2BL 2	40X57	1	59 5/8"
2LG 1	40X114	9	8 5/8"
2LG 2	40X114	26	20 5/8"
2LG 3	40X114	8	59 5/8"
2LG 4	40X114	1	127 7/8"
2LG 5	40X114	1	127 7/8"

Wall 3			
Mark	Profile	Count	Cut Length

3LG 1	40X114	1	127 7/8"
3LG 2	40X114	1	127 7/8"

*Gable-delivered premounted

Log Profiles 1	
Profile	Profile

40X57	
40X95	
40X114	
40X114	

Ontario Bunkie 160 40 (120 1/8"x192 1/8")

List of all items 3



Wall A			
Mark	Profile	Count	Cut Length

ALG 1	40X114	9	73 5/8"
ALG 2	40X114	9	95 7/8"
ALG 3	40X114	8	199 7/8"
ALG 4	40X114	1	231 3/8"
ALG 5	40X114	1	235 1/4"
ALG 6	40X114	1	231 3/8"
ALG 7	40X114	1	231 3/8"
ATL 1	40X145	1	235 1/4"

Wall B			
Mark	Profile	Count	Cut Length



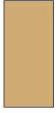
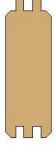





BLG 1	40X114	17	199 7/8"
BLG 2	40X114	1	231 3/8"
BLG 3	40X114	1	235 1/4"
BLG 4	40X114	1	231 3/8"
BLG 5	40X114	1	231 3/8"
BTL 1	40X145	1	235 1/4"

Log Profiles 2	
Profile	Profile

40X95	
40X114	
40X145	

Ontario Bunkie 160 40 (120 1/8"x192 1/8")

List of all items 4

Second floor					Stairs				
Mark	Type	Profile	Count	Cut Length	Mark	Profile	Profile	Count	Cut Length
BM	Beam 40x90		1	116 1/2"	ST1L	40x120		1	91 7/8"
FN1	Fence1 40x70		2	26 3/4"	ST1R	40x120		1	91 7/8"
FN2	Fence1 40x70		2	32 1/4"					
FN3	Fence1 40x70		2	22 7/8"	ST2	143x40		9	20 1/2"
FN4	Fence2 18x95		2	47 1/4"					
FN5	Fence3 18x95		2	46 5/8"					