

Ontario Bunie 40 (106 1/4" x 141 3/4")

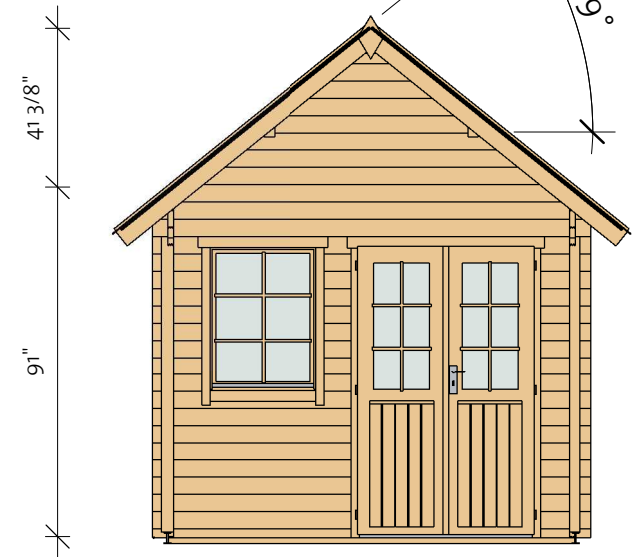

Ontario Bunie 40 (106 1/4" x 141 3/4")

Foundation

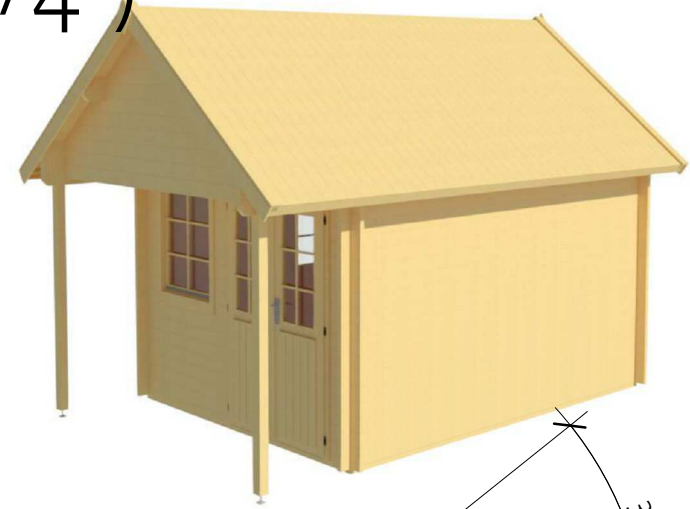
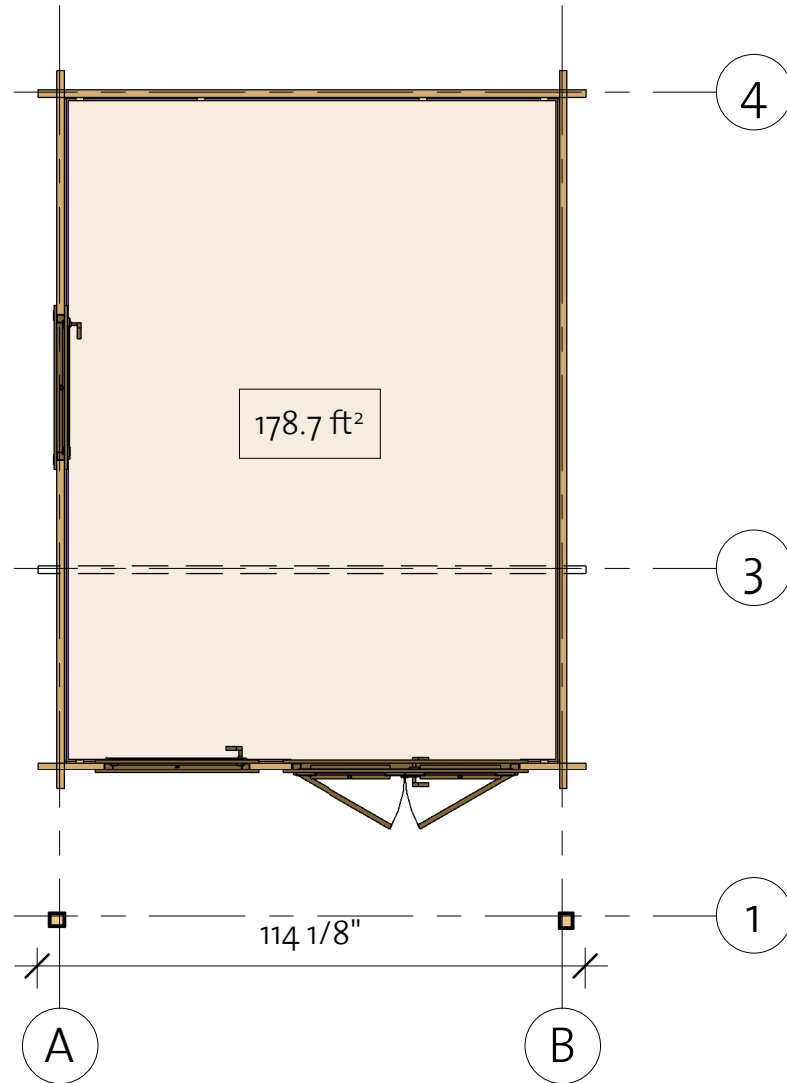
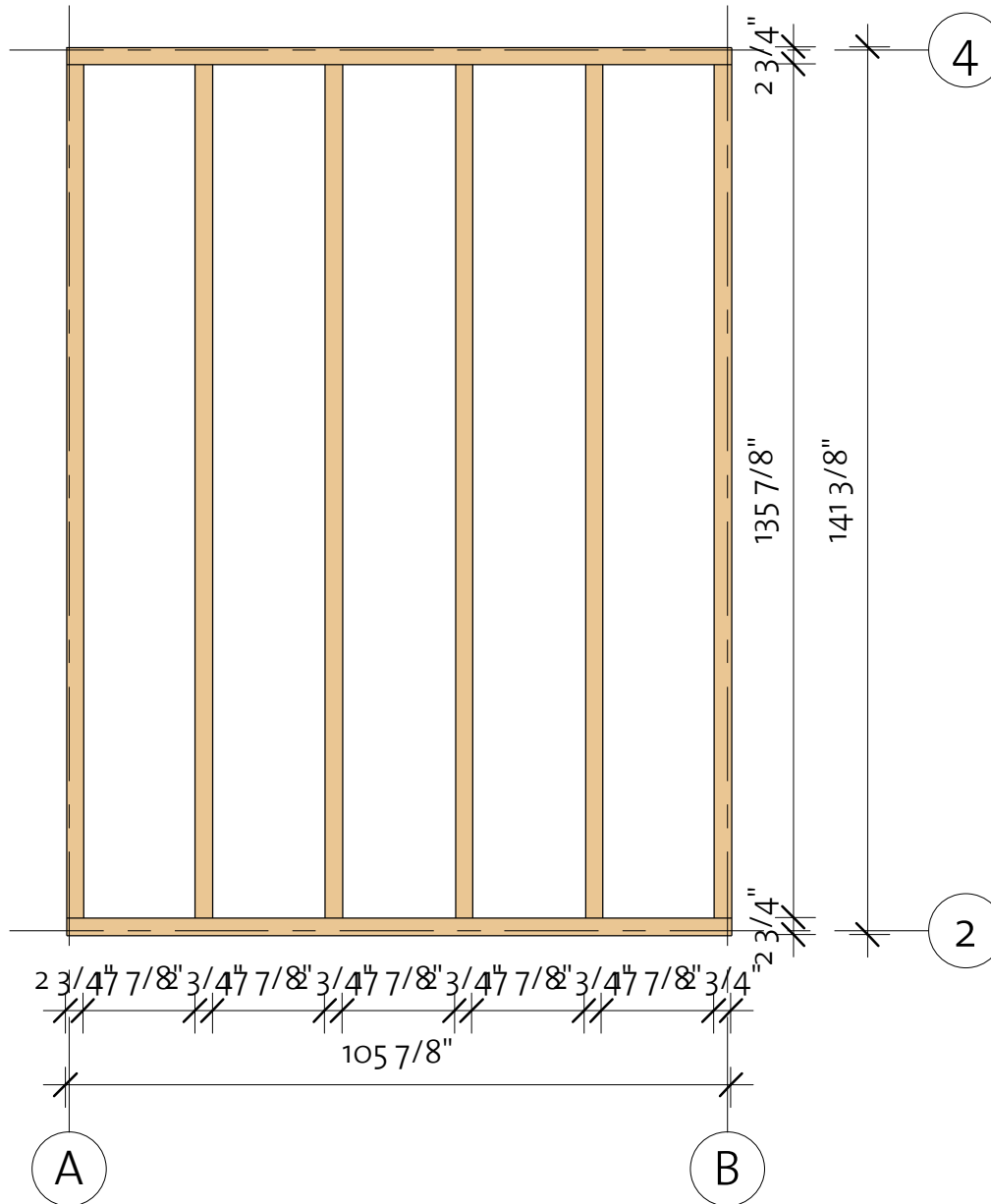

| Impregnated foundation beams | | | | |
|------------------------------|------|---------|-------|--------|
| Mark | Type | Profile | Count | Length |

| | | | | |
|------|--------------|--|---|-------------|
| IFB1 | IFB 70x40 | | 6 | 135 7/8" |
| IFB2 | IFB 70x40 | | 2 | 105 7/8" |

Ontario Bunie 40 (106 1/4" x 141 3/4")

Floor Plan

① Baseboard

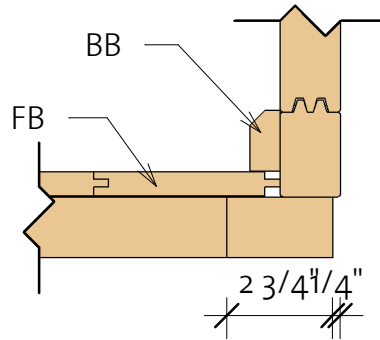

| Floor Schedule | | | | |
|----------------|-----------|---------|-------|----------|
| Mark | Type | Profile | Count | Length |
| FB1 | FB 17x114 | | 32 | 103" |
| FB2 | FB 17x114 | | 24 | 72 7/8" |
| BB | BB 20x40 | | 5 | 149 5/8" |

4200002_200811

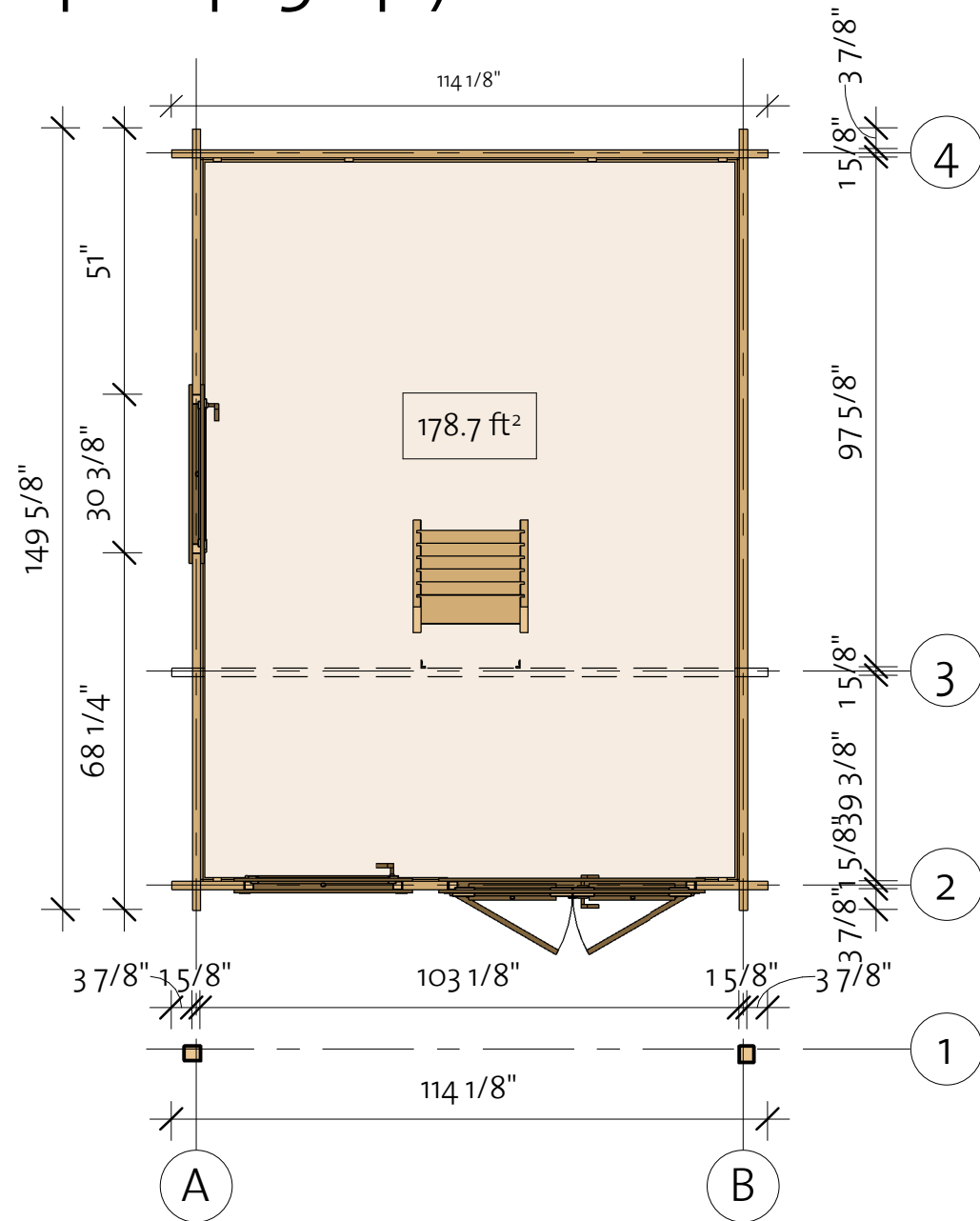

Ontario Bunie 40 (106 1/4" x 141 3/4")

Wall 1

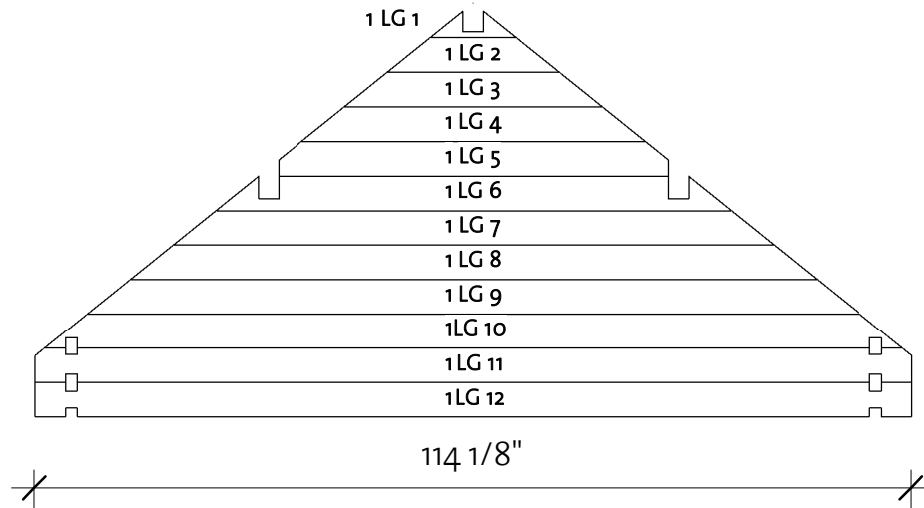
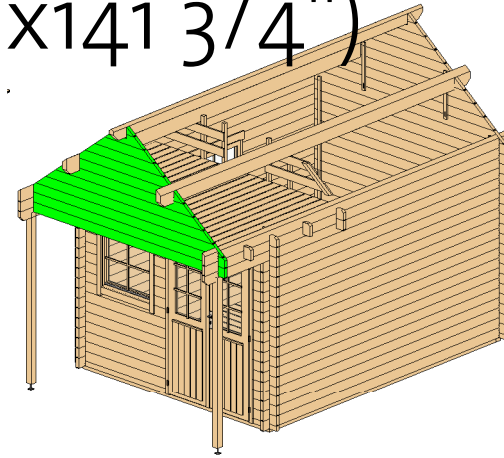

| Wall 1 | | | |
|--------|---------|-------|------------|
| Mark | Profile | Count | Cut Length |

| | | | |
|----------|--------|---|----------|
| 1LG 1 * | 40X114 | 1 | 11 1/4" |
| 1LG 2 * | 40X114 | 1 | 22 3/8" |
| 1LG 3 * | 40X114 | 1 | 33 1/2" |
| 1LG 4 * | 40X114 | 1 | 44 3/4" |
| 1LG 5 * | 40X114 | 1 | 50 5/8" |
| 1LG 6 * | 40X114 | 1 | 67 1/8" |
| 1LG 7 * | 40X114 | 1 | 78 1/4" |
| 1LG 8 * | 40X114 | 1 | 89 3/8" |
| 1LG 9 * | 40X114 | 1 | 100 5/8" |
| 1LG 10 * | 40X114 | 1 | 111 3/4" |
| 1LG 11 * | 40X114 | 1 | 114 1/8" |
| 1LG 12 | 40X114 | 1 | 114 1/8" |

* Gable - delivered premounted

| Log Profile Wall 1 | |
|--------------------|---------|
| Profile | Profile |

| | |
|--------|--|
| 40X114 | |
|--------|--|

Ontario Bunie 40 (106 1/4" x 141 3/4")

Wall 2

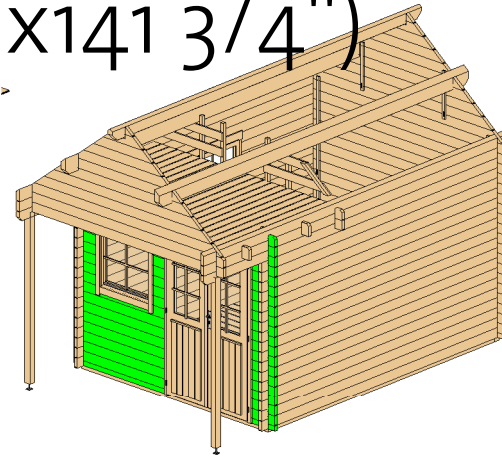

| Wall 2 | | | |
|--------|---------|-------|------------|
| Mark | Profile | Count | Cut Length |

| | | | |
|-------|--------|----|----------|
| 2BL 1 | 40x57 | 1 | 13 3/4" |
| 2BL 2 | 40x57 | 1 | 52 3/4" |
| 2LG 1 | 40x114 | 9 | 8 5/8" |
| 2LG 2 | 40x114 | 26 | 13 3/4" |
| 2LG 3 | 40x114 | 8 | 52 3/4" |
| 2LG 4 | 40x114 | 1 | 114 1/8" |
| 2LG 5 | 40x114 | 1 | 114 1/8" |

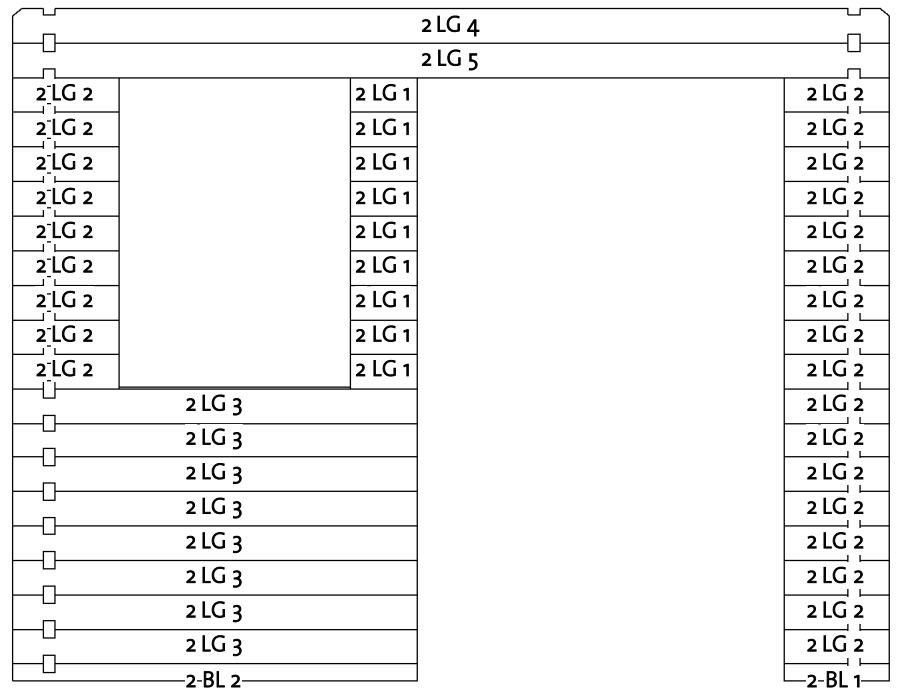

| Log Profile Wall 2 | |
|--------------------|---------|
| Profile | Images4 |

| | |
|--------|--|
| 40x57 | |
| 40x114 | |
| 40x114 | |

Ontario Bunie 40 (106 1/4" x 141 3/4")

Wall 3

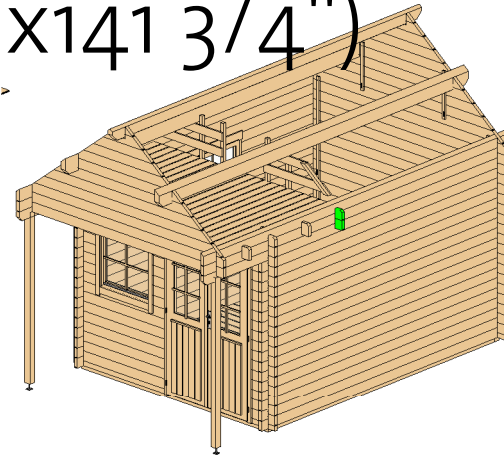

| Wall 3 | | | |
|--------|---------|-------|------------|
| Mark | Profile | Count | Cut Length |

| | | | |
|-------|--------|---|----------|
| 3LG 1 | 4OX114 | 1 | 114 1/8" |
| 3LG 2 | 4OX114 | 1 | 114 1/8" |

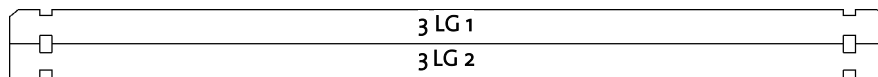

| Log Profile Wall 3 | |
|--------------------|---------|
| Profile | Images4 |

| | |
|--------|--|
| 4OX114 | |
| 4OX114 | |

Ontario Bunie 40 (106 1/4" x 141 3/4")

Wall 4

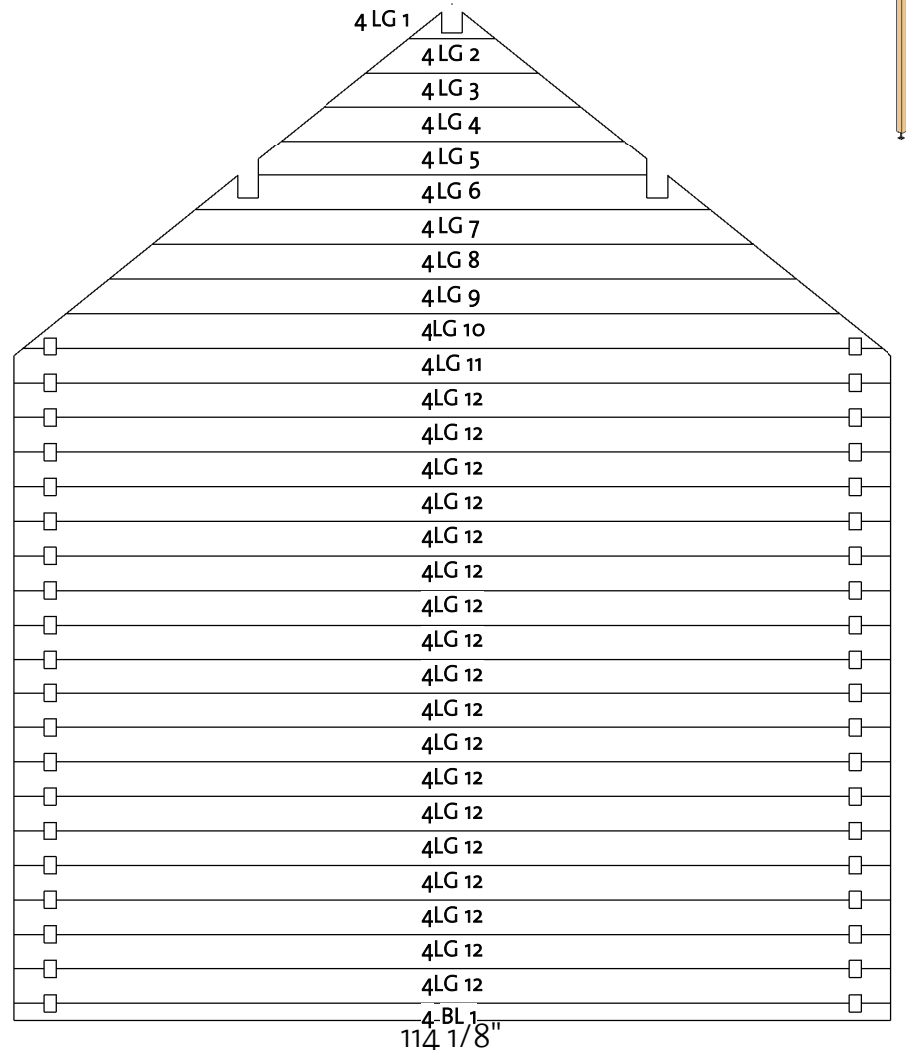
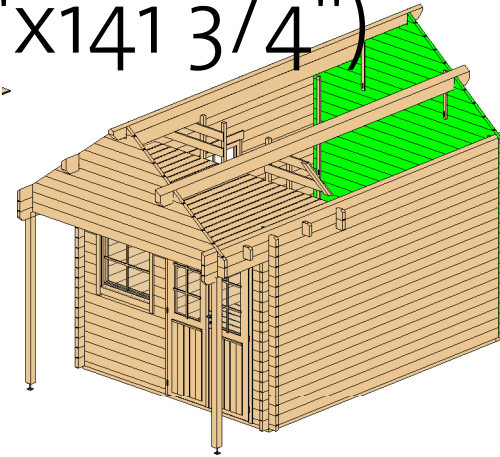

| Wall 4 | | | |
|--------|---------|-------|------------|
| Mark | Profile | Count | Cut Length |

| | | | |
|----------|--------|----|----------|
| 4BL 1 | 40X57 | 1 | 114 1/8" |
| 4LG 1 * | 40X114 | 1 | 11 1/4" |
| 4LG 2 * | 40X114 | 1 | 22 3/8" |
| 4LG 3 * | 40X114 | 1 | 33 1/2" |
| 4LG 4 * | 40X114 | 1 | 44 3/4" |
| 4LG 5 * | 40X114 | 1 | 50 5/8" |
| 4LG 6 * | 40X114 | 1 | 67 1/8" |
| 4LG 7 * | 40X114 | 1 | 78 1/4" |
| 4LG 8 * | 40X114 | 1 | 89 3/8" |
| 4LG 9 * | 40X114 | 1 | 100 5/8" |
| 4LG 10 * | 40X114 | 1 | 111 3/4" |
| 4LG 11 * | 40X114 | 1 | 114 1/8" |
| 4LG 12 | 40X114 | 18 | 114 1/8" |

* Gable - delivered premounted

| Log Profile Wall 4 | |
|--------------------|---------|
| Profile | Profile |

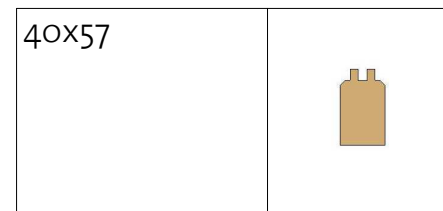

| Log Profile Wall 4 | |
|--------------------|---------|
| Profile | Profile |

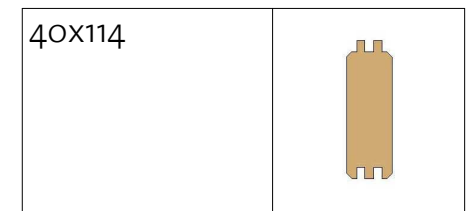

Ontario Bunie 40 (106 1/4" x 141 3/4")

Wall A

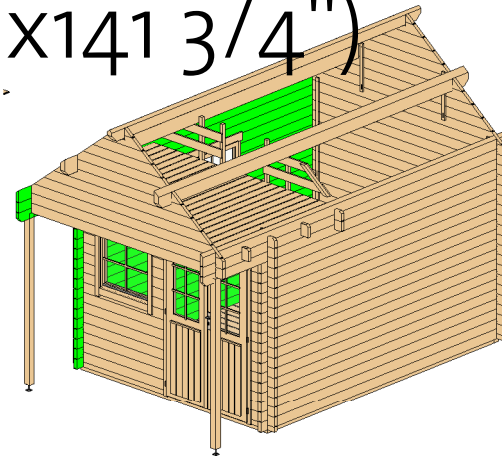

| Wall A | | | |
|--------|---------|-------|------------|
| Mark | Profile | Count | Cut Length |

| | | | |
|-------|--------|---|----------|
| ALG 1 | 40x114 | 9 | 51" |
| ALG 2 | 40x114 | 9 | 68 1/4" |
| ALG 3 | 40x114 | 8 | 149 5/8" |
| ALG 4 | 40x114 | 1 | 185" |
| ALG 5 | 40x114 | 1 | 189" |
| ATL 1 | 40x145 | 1 | 189" |

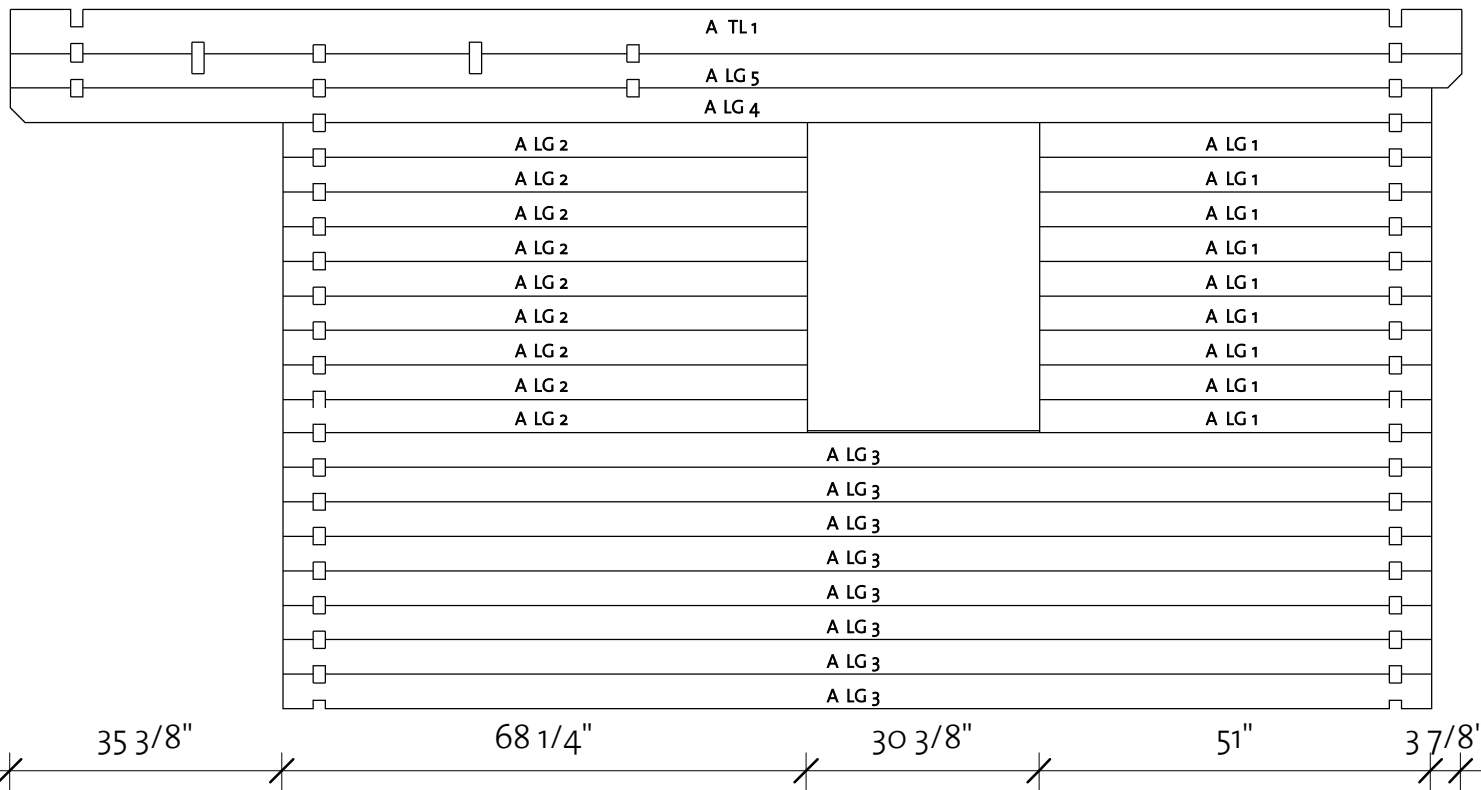

| Log Profile Wall A | |
|--------------------|---------|
| Profile | Profile |

| | |
|--------|--|
| 40x114 | |
| 40x145 | |

Ontario Bunie 40 (106 1/4" x 141 3/4")

Wall B

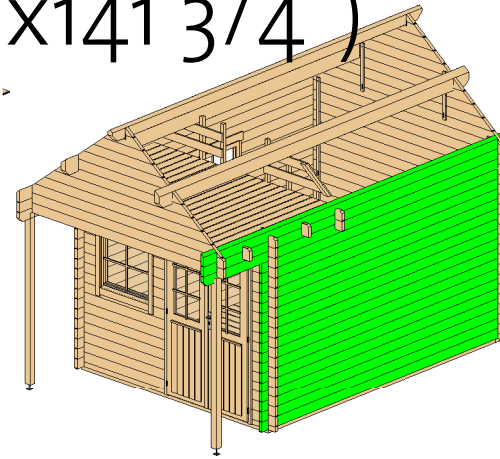

| Wall B | | | |
|--------|---------|-------|------------|
| Mark | Profile | Count | Cut Length |

| | | | |
|-------|--------|----|----------|
| BLG 1 | 40X114 | 17 | 149 5/8" |
| BLG 2 | 40X114 | 1 | 185" |
| BLG 3 | 40X114 | 1 | 189" |
| BTL 1 | 40X145 | 1 | 189" |

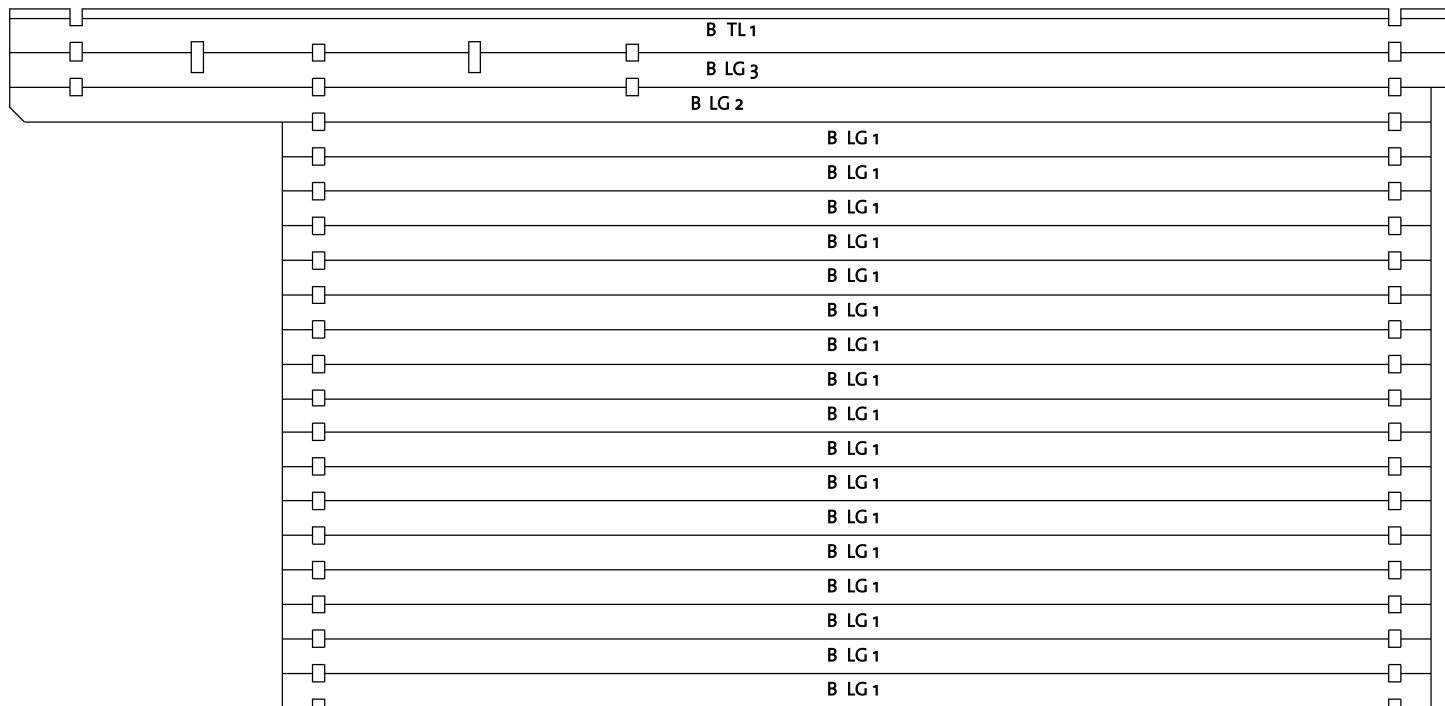

| Log Profile Wall B | |
|--------------------|---------|
| Profile | Profile |

| | |
|--------|--|
| 40X114 | |
| 40X145 | |



Ontario Bunie 40 (106 1/4" x 141 3/4")

Second floor

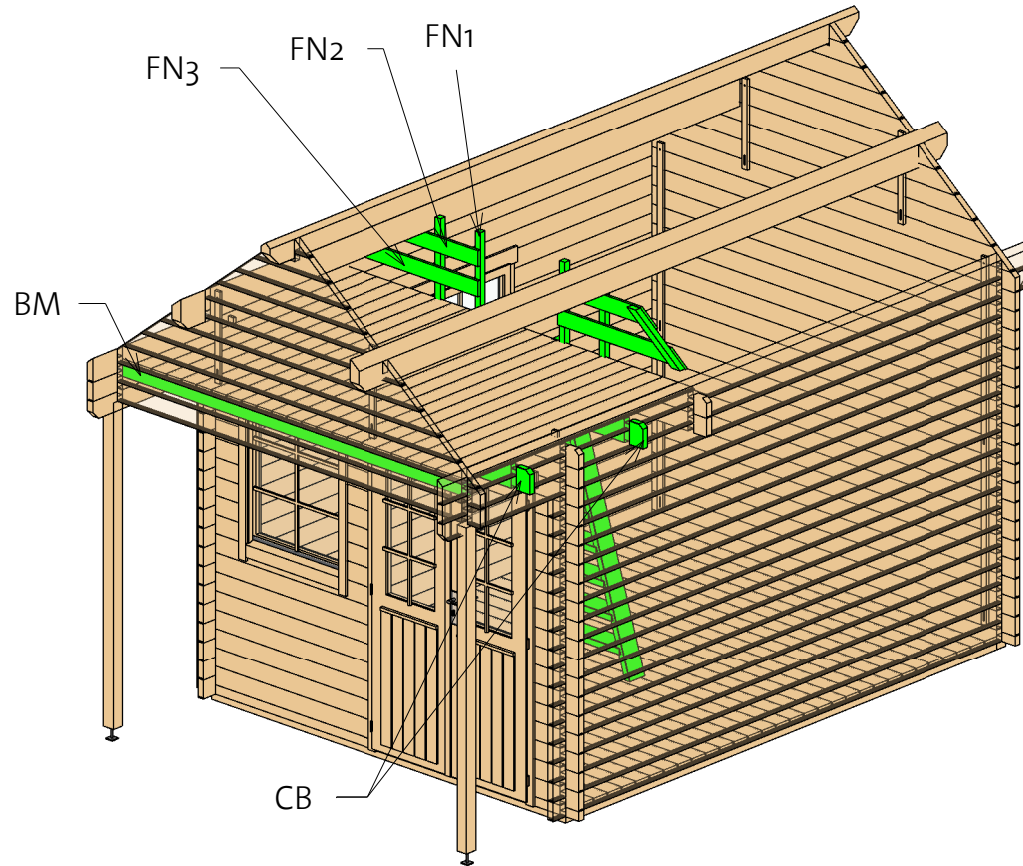

Second floor

| Mark | Type | Profile | Count | Cut Length |
|------|---------------------------|---------|-------|------------|
| FN3 | Fence3 18x95 | | 2 | 38 1/8" |
| BM | Beam 40x90 | | 1 | 103 1/8" |
| CB | Ceiling beam 40x143 | | 2 | 114 1/8" |
| FN1 | Fence1 38x38 | | 6 | 26 3/4" |
| FN2 | Fence2 18x95 | | 2 | 29 1/4" |

Ontario Bunie 40 (106 1/4" x 141 3/4")

Fence

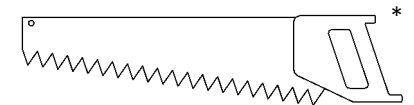
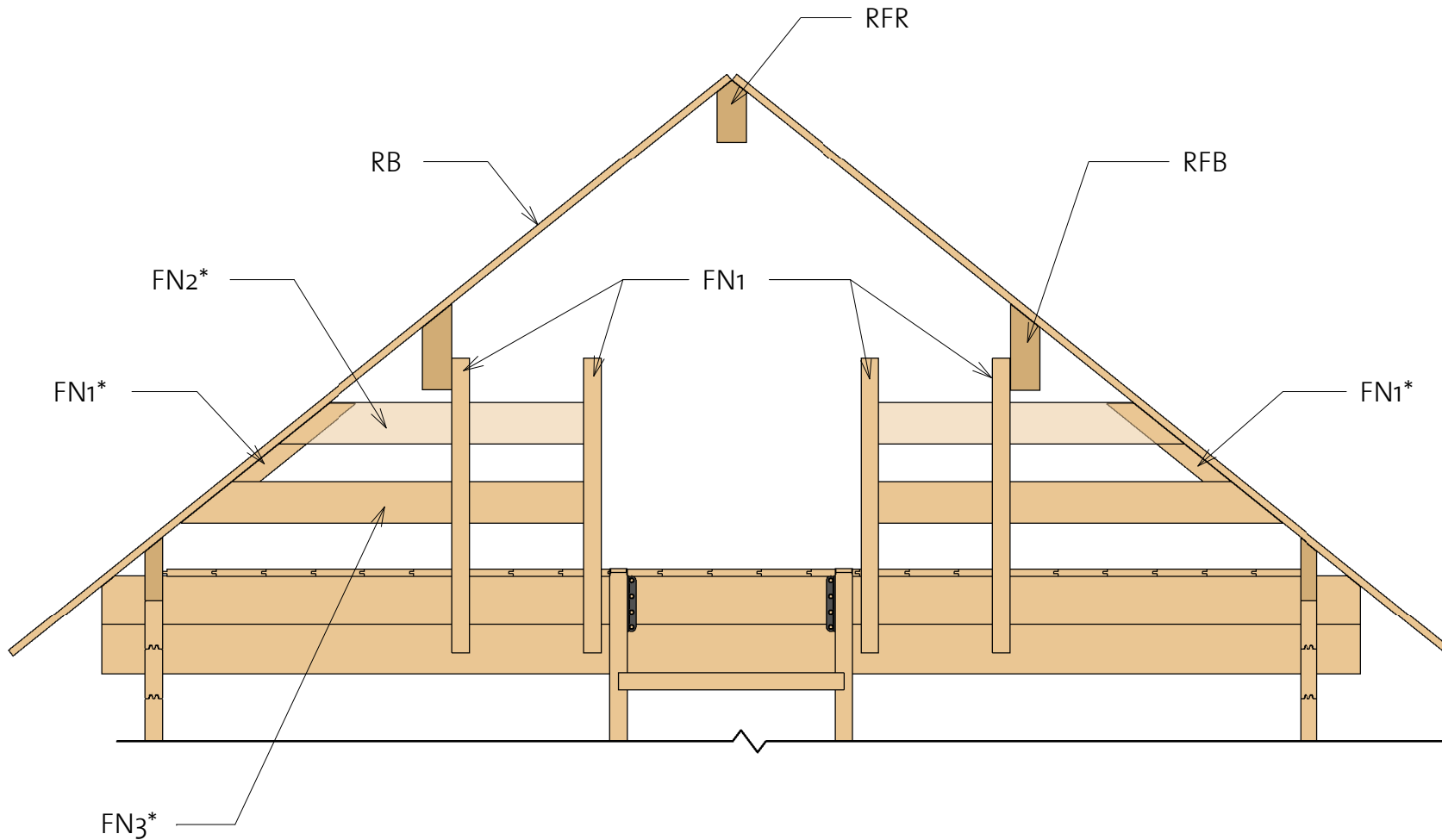

Ontario Bunie 40 (106 1/4" x 141 3/4")

Stair

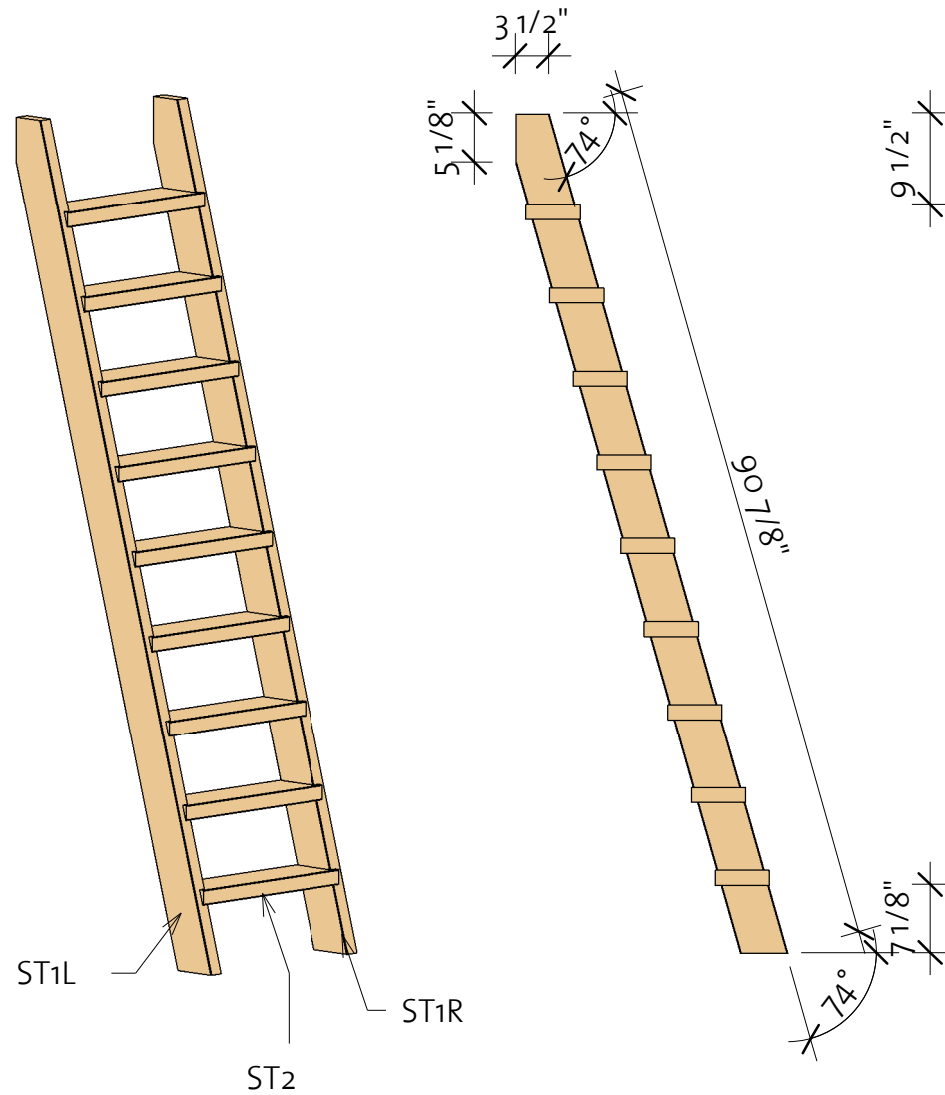

| Stairs | | | | |
|--------|---------|---------|-------|------------|
| Mark | Profile | Profile | Count | Cut Length |
| ST1L | 40X120 | | 1 | 91 7/8" |
| ST1R | 40X120 | | 1 | 91 7/8" |
| ST2 | 143X40 | | 9 | 20 1/2" |

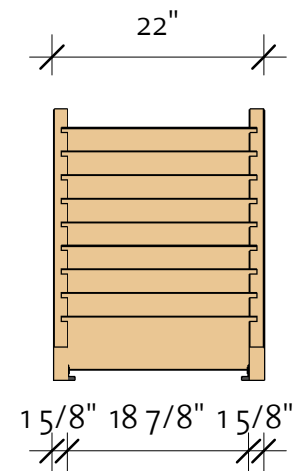

Ontario Bunie 40 (106 1/4" x 141 3/4")

Roof 1

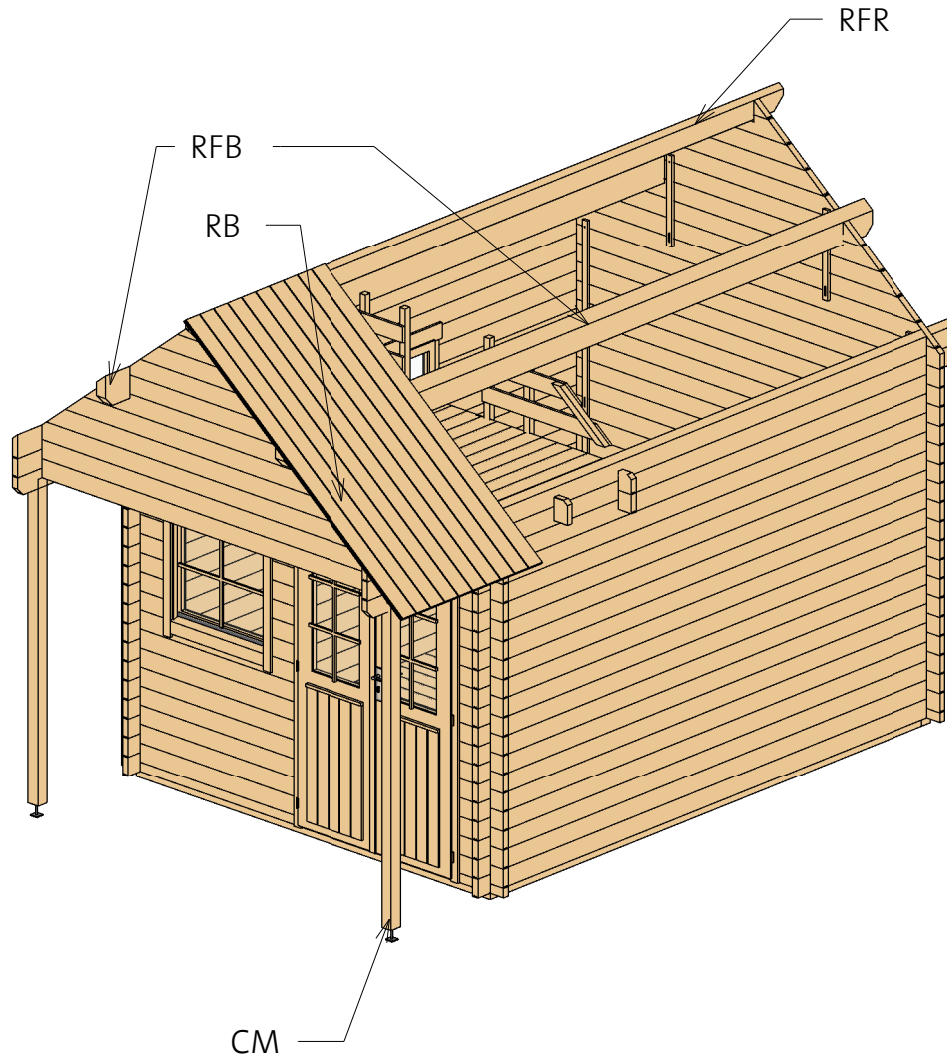

| Roof | | | | |
|------|------|---------|-------|--------|
| Mark | Type | Profile | Count | Length |

| | | | | |
|-----|-----------------|--|----|---------|
| RFR | Ridge 68x143 | | 1 | 189" |
| RFB | Beam 68x193 | | 2 | 189" |
| RB | 17x114 | | 86 | 83 1/2" |

| Post | | | |
|------|---------|-------|--------|
| Mark | Profile | Count | Length |

| | | | |
|----|------------|---|---------|
| CM | Post 80x70 | 2 | 77 1/8" |
|----|------------|---|---------|

Ontario Bunie 40 (106 1/4" x 141 3/4")

Fascia Schedule

| Mark | Type | Profile | Count | Length |
|------|-----------------------------|---------|-------|---------|
| EE | Eave Edging 18x95 | | 4 | 85 3/8" |
| RF | Roof Fascia 18x120 | | 4 | 85 3/8" |
| RR1 | Roof reinforcement 18x95 | | 2 | 189" |
| RR2 | Roof reinforcement 38x38 | | 2 | 189" |

Roof 2

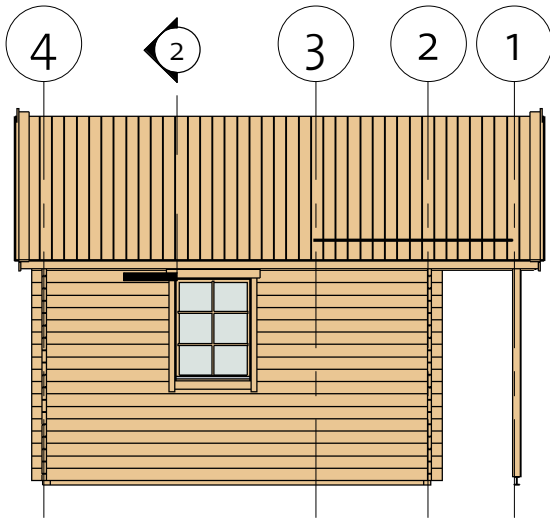

② Facia

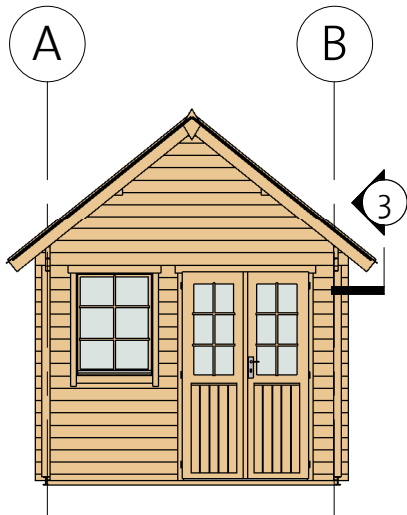
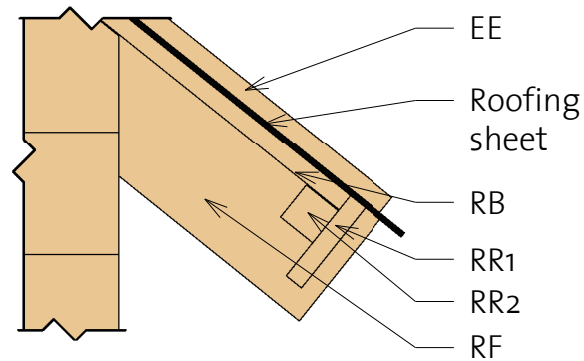

③ Roof Reinforcement

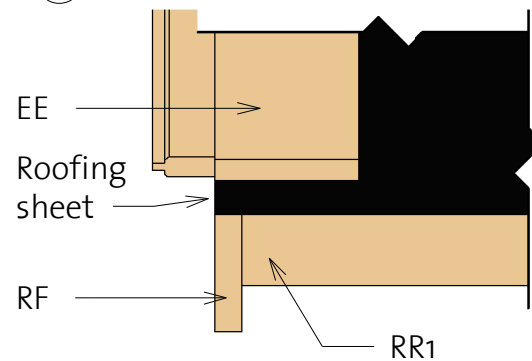

Ontario Bunie 40 (106 1/4" x 141 3/4")

Extras

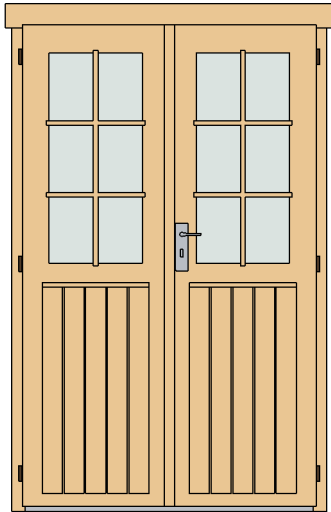

| Door Schedule | | | | |
|---------------|-----------------------------|---------|--------|-------|
| Model | Type | Width | Height | Count |
| CDD5R | Classic double door 5 right | 47 1/4" | 77" | 1 |
| DCB6-5 | Door Crossbar 6-5 | -- | -- | 1/8" |

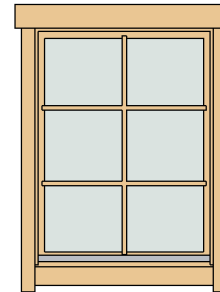

| Window Schedule | | | | |
|-----------------|------------------------|---------|--------|-------|
| Model | Type | Width | Height | Count |
| CW1R | Classic window 1 right | 30 1/8" | 39" | 2 |
| WCB6 | Windows Crossbar 6 | -- | -- | 2 |

| Fasteners & Extras | | |
|--------------------|------|-------|
| Name | Type | Count |

| | | |
|-----------------|------------|-----|
| Hitblock | 300-400 mm | |
| Ladder fittings | | 2 |
| Screws | 6,0x160 | 6 |
| Bolts | M8 x 70 | 20 |
| Screws | 5,0 x 70 | 45 |
| Nails | 1,4 x 40 | 50 |
| Screws | 6,0 x 140 | 80 |
| Screws | 4,0 x 40 | 820 |

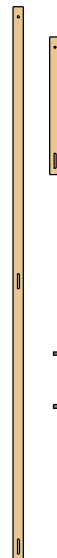

| Type | Count | Length |
|----------------------|-------|---------|
| Adjustable post foot | 2 | 3" |
| Windboard1 18x40 | 4 | 86 5/8" |
| Windboard2 18x40 | 4 | 21 5/8" |

| Family | Count |
|--------|-------|
| Romb | 2 |





4200002_200811

Ontario Bunie 40 (106 1/4"x141 3/4")

List of all items 1

Impregnated foundation beams



| Mark | Type | Profile | Count | Length |
|------|------|---------|-------|--------|
|------|------|---------|-------|--------|

| | | | | |
|------|--------------|---|---|-------------|
| IFB1 | IFB 70x40 |  | 6 | 135 7/8" |
| IFB2 | IFB 70x40 |  | 2 | 105 7/8" |

| | | | | |
|----|-------------|---|---|-------------|
| BB | BB 20x40 |  | 5 | 149 5/8" |
|----|-------------|---|---|-------------|



Floor Schedule

| Mark | Type | Profile | Count | Length |
|------|------|---------|-------|--------|
|------|------|---------|-------|--------|

| | | | | |
|-----|-----------|---|----|---------|
| FB1 | FB 17x114 |  | 32 | 103" |
| FB2 | FB 17x114 |  | 24 | 72 7/8" |



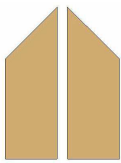

Roof

| Mark | Type | Profile | Count | Length |
|------|------|---------|-------|--------|
|------|------|---------|-------|--------|

| | | | | |
|-----|-----------------|---|----|---------|
| RFR | Ridge 68x143 |  | 1 | 189" |
| RFB | Beam 68x193 |  | 2 | 189" |
| RB | 17x114 |  | 86 | 83 1/2" |

Fascia Schedule

| Mark | Type | Profile | Count | Length |
|------|------|---------|-------|--------|
|------|------|---------|-------|--------|

| | | | | |
|-----|--------------------------------|---|---|---------|
| EE | Eave Edging 18x95 |  | 4 | 85 3/8" |
| RF | Roof Fascia 18x120 |  | 4 | 85 3/8" |
| RR1 | Roof reinforcement 18x95 |  | 2 | 189" |
| RR2 | Roof reinforcement 38x38 |  | 2 | 189" |

Ontario Bunie 40 (106 1/4"x141 3/4")

List of all items 2

| Wall 1 | | | |
|--------|---------|-------|------------|
| Mark | Profile | Count | Cut Length |

| | | | |
|----------|--------|---|----------|
| 1LG 1 * | 40X114 | 1 | 11 1/4" |
| 1LG 2 * | 40X114 | 1 | 22 3/8" |
| 1LG 3 * | 40X114 | 1 | 33 1/2" |
| 1LG 4 * | 40X114 | 1 | 44 3/4" |
| 1LG 5 * | 40X114 | 1 | 50 5/8" |
| 1LG 6 * | 40X114 | 1 | 67 1/8" |
| 1LG 7 * | 40X114 | 1 | 78 1/4" |
| 1LG 8 * | 40X114 | 1 | 89 3/8" |
| 1LG 9 * | 40X114 | 1 | 100 5/8" |
| 1LG 10 * | 40X114 | 1 | 111 3/4" |
| 1LG 11 * | 40X114 | 1 | 114 1/8" |
| 1LG 12 | 40X114 | 1 | 114 1/8" |

| Wall 4 | | | |
|--------|---------|-------|------------|
| Mark | Profile | Count | Cut Length |

| | | | |
|----------|--------|----|----------|
| 4BL 1 | 40X57 | 1 | 114 1/8" |
| 4LG 1 * | 40X114 | 1 | 11 1/4" |
| 4LG 2 * | 40X114 | 1 | 22 3/8" |
| 4LG 3 * | 40X114 | 1 | 33 1/2" |
| 4LG 4 * | 40X114 | 1 | 44 3/4" |
| 4LG 5 * | 40X114 | 1 | 50 5/8" |
| 4LG 6 * | 40X114 | 1 | 67 1/8" |
| 4LG 7 * | 40X114 | 1 | 78 1/4" |
| 4LG 8 * | 40X114 | 1 | 89 3/8" |
| 4LG 9 * | 40X114 | 1 | 100 5/8" |
| 4LG 10 * | 40X114 | 1 | 111 3/4" |
| 4LG 11 * | 40X114 | 1 | 114 1/8" |
| 4LG 12 | 40X114 | 18 | 114 1/8" |

| Wall 2 | | | |
|--------|---------|-------|------------|
| Mark | Profile | Count | Cut Length |



| | | | |
|-------|--------|----|----------|
| 2BL 1 | 40X57 | 1 | 13 3/4" |
| 2BL 2 | 40X57 | 1 | 52 3/4" |
| 2LG 1 | 40X114 | 9 | 8 5/8" |
| 2LG 2 | 40X114 | 26 | 13 3/4" |
| 2LG 3 | 40X114 | 8 | 52 3/4" |
| 2LG 4 | 40X114 | 1 | 114 1/8" |
| 2LG 5 | 40X114 | 1 | 114 1/8" |

| Wall 3 | | | |
|--------|---------|-------|------------|
| Mark | Profile | Count | Cut Length |

| | | | |
|-------|--------|---|----------|
| 3LG 1 | 40X114 | 1 | 114 1/8" |
| 3LG 2 | 40X114 | 1 | 114 1/8" |

*Gable-delivered premounted

| Log Profiles 1 | |
|----------------|---------|
| Profile | Profile |

| | |
|--------|---|
| 40X57 |  |
| 40X114 |  |
| 40X114 |  |

Ontario Bunie 40 (106 1/4"x141 3/4")

List of all items 3

| Wall A | | | |
|--------|---------|-------|------------|
| Mark | Profile | Count | Cut Length |

| | | | |
|-------|--------|---|----------|
| ALG 1 | 40X114 | 9 | 51" |
| ALG 2 | 40X114 | 9 | 68 1/4" |
| ALG 3 | 40X114 | 8 | 149 5/8" |
| ALG 4 | 40X114 | 1 | 185" |
| ALG 5 | 40X114 | 1 | 189" |
| ATL 1 | 40X145 | 1 | 189" |

| Wall B | | | |
|--------|---------|-------|------------|
| Mark | Profile | Count | Cut Length |





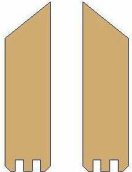



| | | | |
|-------|--------|----|----------|
| BLG 1 | 40X114 | 17 | 149 5/8" |
| BLG 2 | 40X114 | 1 | 185" |
| BLG 3 | 40X114 | 1 | 189" |
| BTL 1 | 40X145 | 1 | 189" |

| Log Profiles 2 | |
|----------------|---------|
| Profile | Profile |

| | |
|--------|---|
| 40X114 |  |
| 40X145 |  |

Ontario Bunie 40 (106 1/4"x141 3/4")

List of all items 4

| Second floor | | | | | Stairs | | | | |
|--------------|---------------------------|---|-------|------------|--------|---------|--|-------|------------|
| Mark | Type | Profile | Count | Cut Length | Mark | Profile | Profile | Count | Cut Length |
| FN3 | Fence3 18x95 |  | 2 | 38 1/8" | ST1L | 40x120 |  | 1 | 91 7/8" |
| BM | Beam 40x90 |  | 1 | 103 1/8" | ST1R | 40x120 |  | 1 | 91 7/8" |
| CB | Ceiling beam 40x143 |  | 2 | 114 1/8" | ST2 | 143x40 |  | 9 | 20 1/2" |
| FN1 | Fence1 38x38 |  | 6 | 26 3/4" | | | | | |
| FN2 | Fence2 18x95 |  | 2 | 29 1/4" | | | | | |

| Post | | | |
|------|------------|-------|---------|
| Mark | Profile | Count | Length |
| CM | Post 80x70 | 2 | 77 1/8" |