

Rivercrest 40 (222"x222")

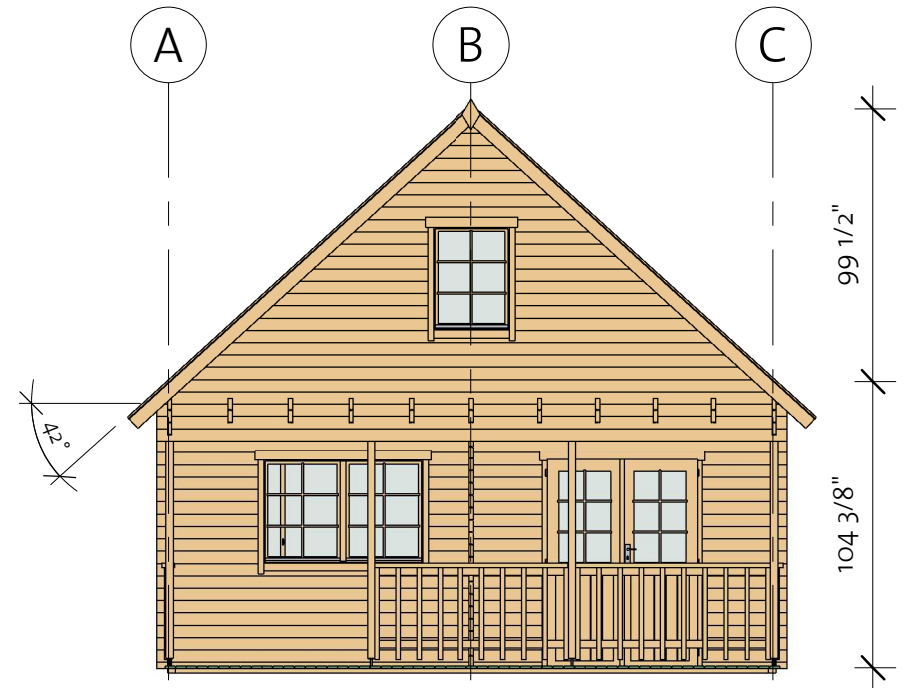
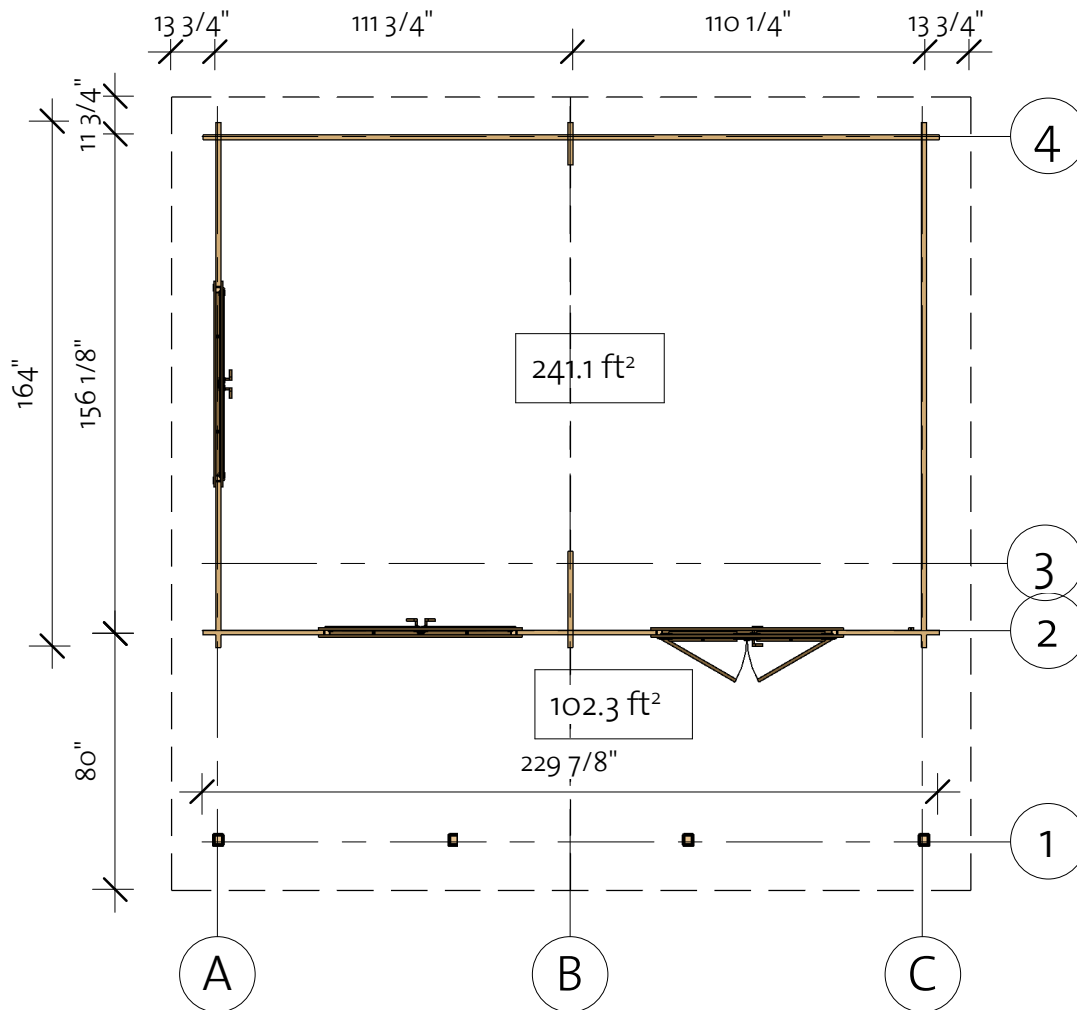

Rivercrest 40 (222"x222")

Floor Plan

① Baseboard

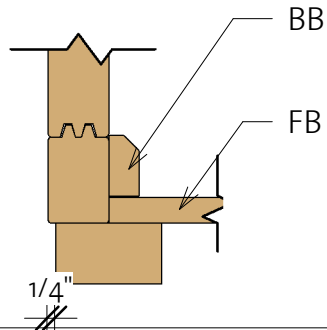

Floor Schedule

Mark	Type	Profile	Count	Length
------	------	---------	-------	--------

FB1	FB 17x114		49	152 3/4"
FB2	FB 17x114		19	218 3/4"

BB 1	BB 18x40		5	220 1/2"
------	----------	--	---	----------

Terrace Schedule

TB	TB 21x95		57	65 7/8"
----	----------	--	----	---------

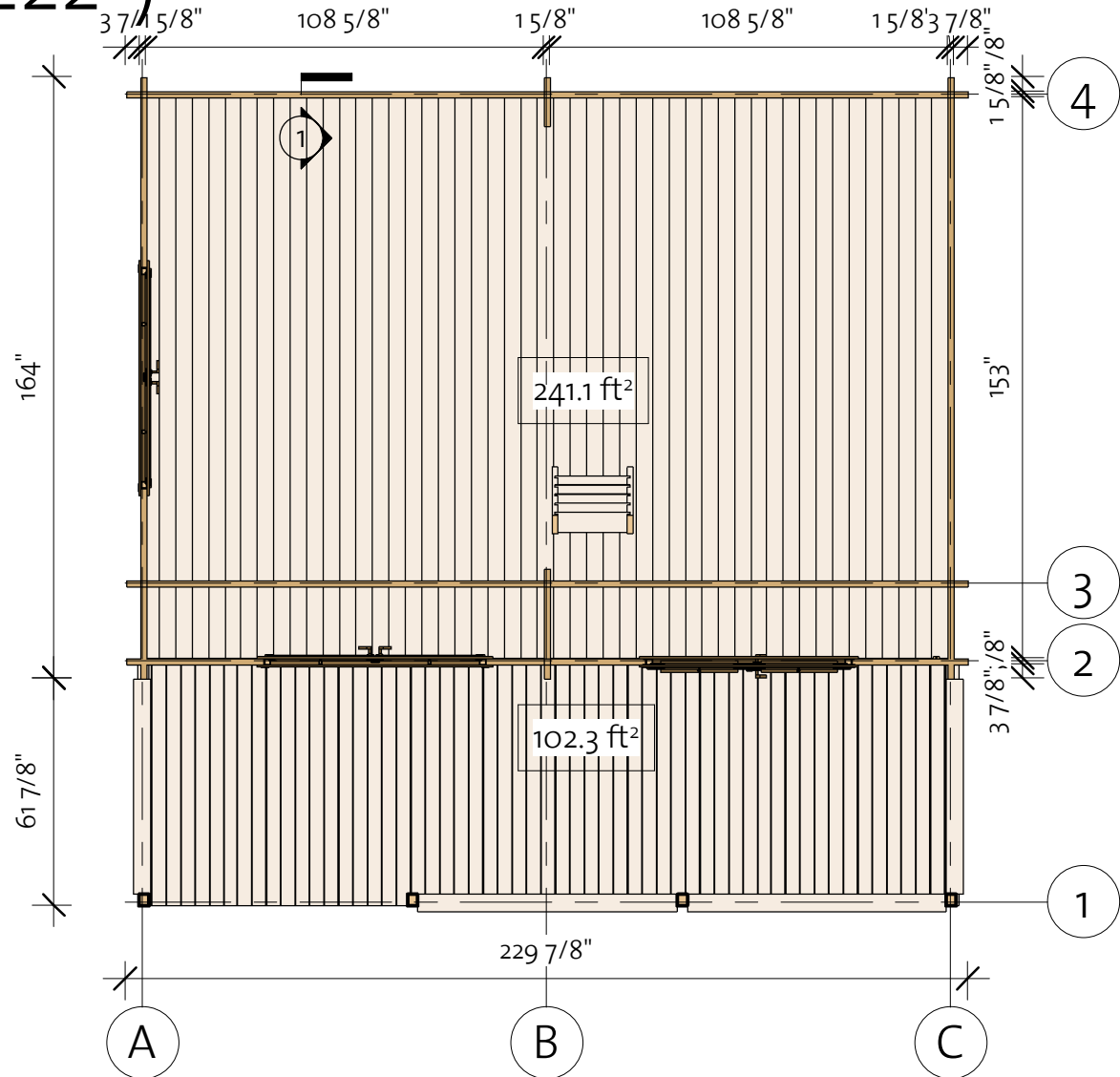

Rivercrest 40 (222"x222")

Wall 1

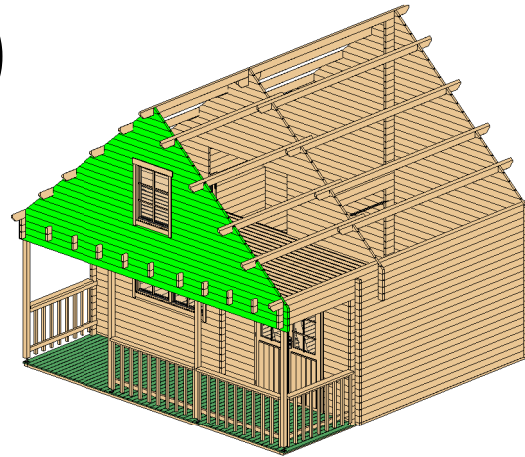

Log Profile Wall 1	
Profile	Profile

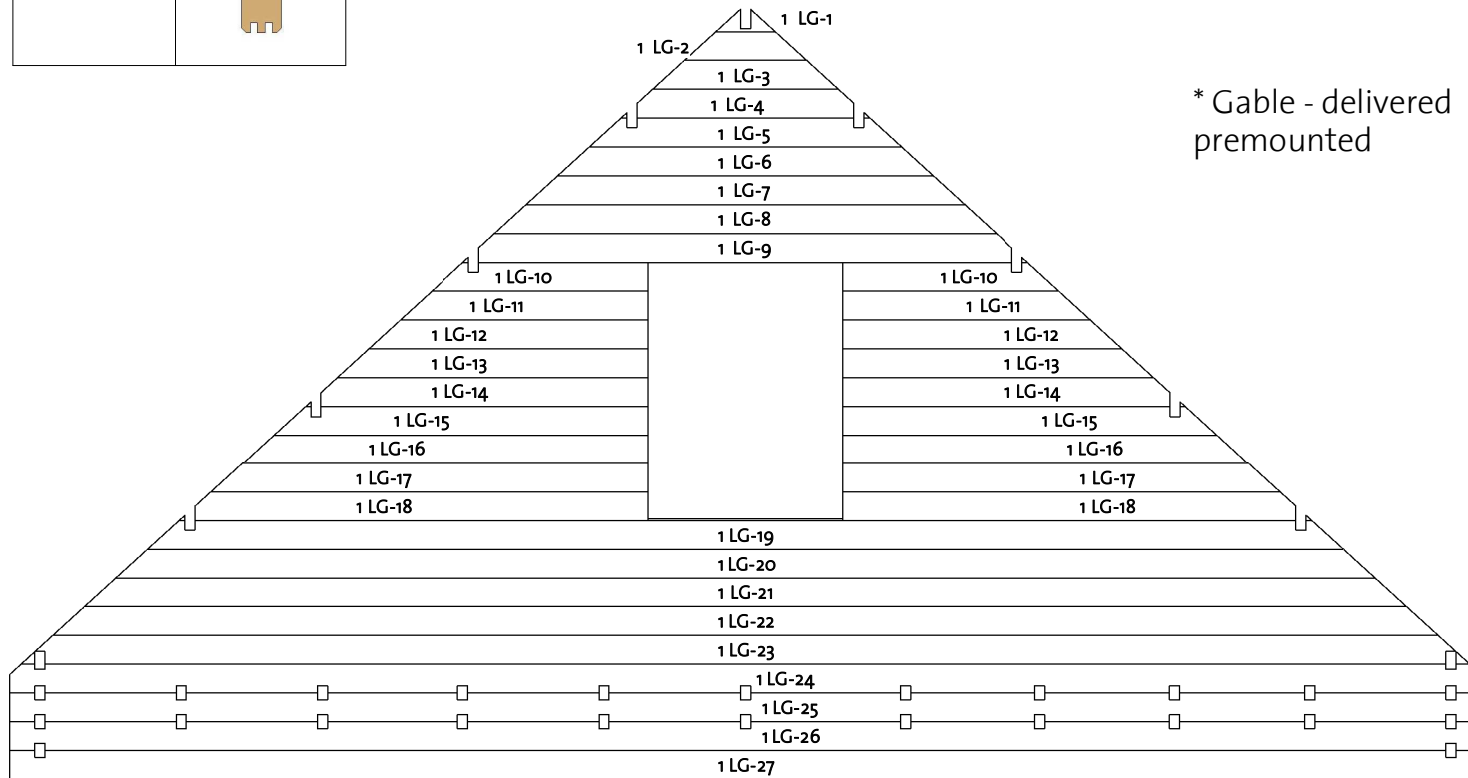
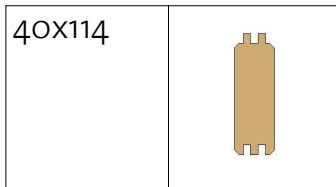

* Gable - delivered premounted

Wall 1			
Mark	Profile	Count	Cut Length

1LG-1 *	4OX114	1	9 1/4"
1LG-2 *	4OX114	1	19 1/8"
1LG-3 *	4OX114	1	29"
1LG-4 *	4OX114	1	38 7/8"
1LG-5 *	4OX114	1	48 5/8"
1LG-6 *	4OX114	1	58 1/2"
1LG-7 *	4OX114	1	68 3/8"
1LG-8 *	4OX114	1	78 1/4"
1LG-9 *	4OX114	1	88 1/8"
1LG-10 *	4OX114	2	33 7/8"
1LG-11 *	4OX114	2	38 3/4"
1LG-12 *	4OX114	2	43 3/4"
1LG-13 *	4OX114	2	48 5/8"
1LG-14 *	4OX114	2	53 5/8"
1LG-15 *	4OX114	2	58 1/2"
1LG-16 *	4OX114	2	63 1/2"
1LG-17 *	4OX114	2	68 3/8"
1LG-18 *	4OX114	2	73 3/8"
1LG-19 *	4OX114	1	186 7/8"
1LG-20 *	4OX114	1	196 3/4"
1LG-21 *	4OX114	1	206 5/8"
1LG-22 *	4OX114	1	216 3/8"
1LG-23 *	4OX114	1	226 1/4"
1LG-24 *	4OX114	1	229 7/8"
1LG-25	4OX114	1	229 7/8"
1LG-26	4OX114	1	229 7/8"
1LG-27	4OX114	1	229 7/8"

Rivercrest 40 (222"x222")

Wall 2

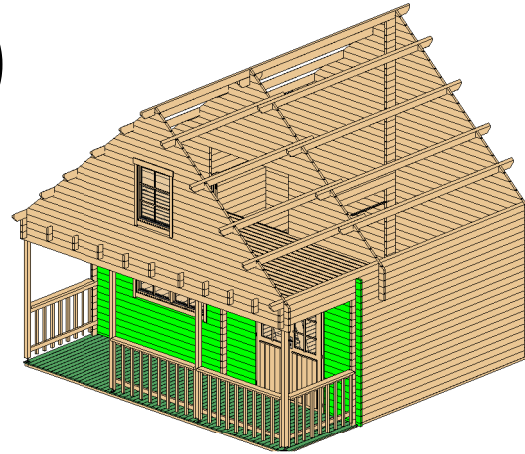

Wall 2			
Mark	Profile	Count	Cut Length

2BL-1	40X57	1	31 5/8"
2BL-2	40X57	1	141 5/8"
2LG-1	40X114	9	43 1/4"
2LG-2	40X114	9	37 5/8"
2LG-3	40X114	17	31 5/8"
2LG-4	40X114	1	229 7/8"
2LG-5	40X114	8	141 5/8"
2LG-6	40X57	1	229 7/8"
2LG-7	40X114	1	229 7/8"
2LG-8	40X114	1	229 7/8"
2LG-9	40X114	1	229 7/8"

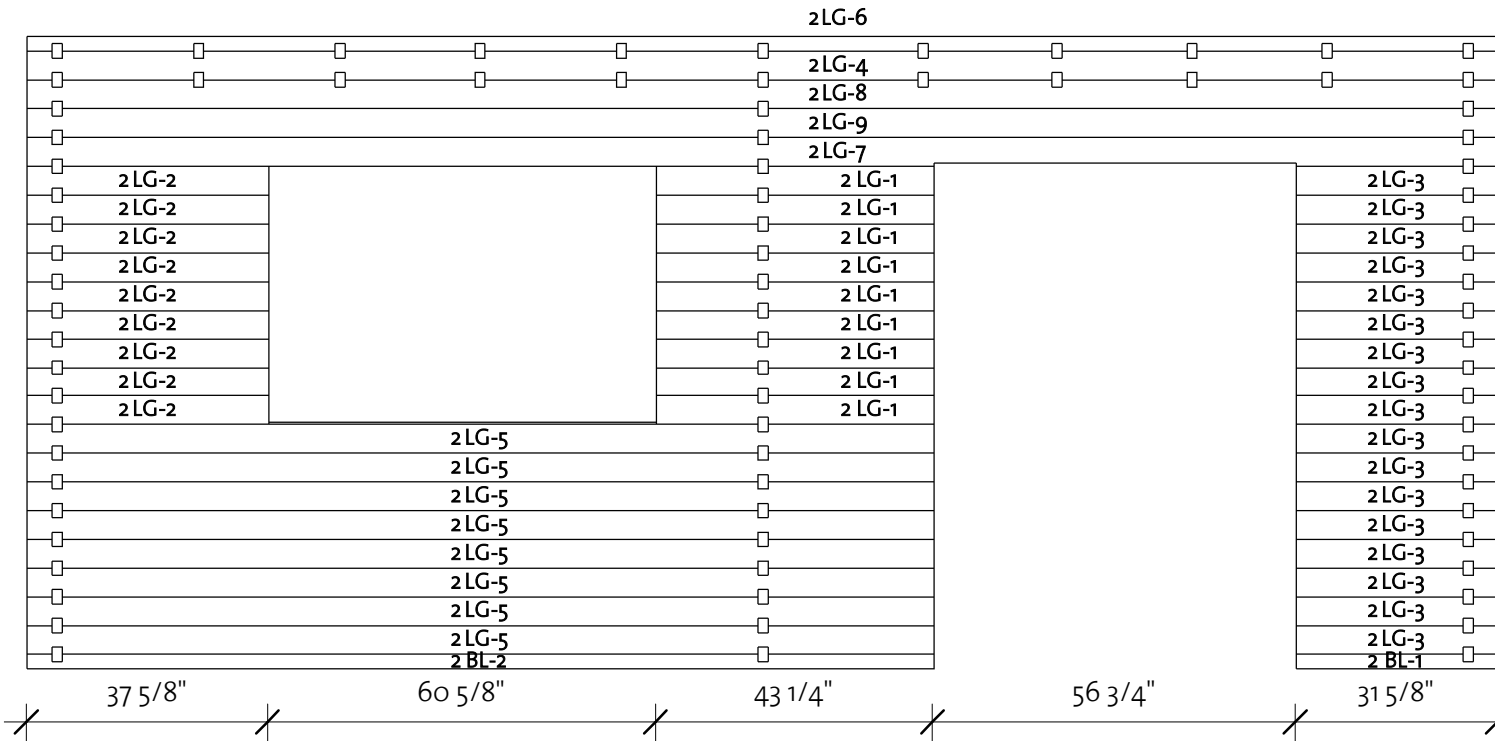

Log Profile Wall 2	
Profile	Profile

40X57	
40X114	

Rivercrest 40 (222"x222")

Wall 3

Log Profile Wall 3	
Profile	Profile

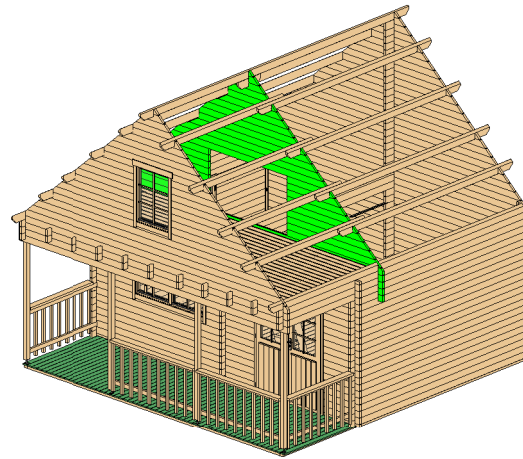
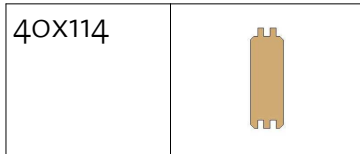

* Gable - delivered premounted

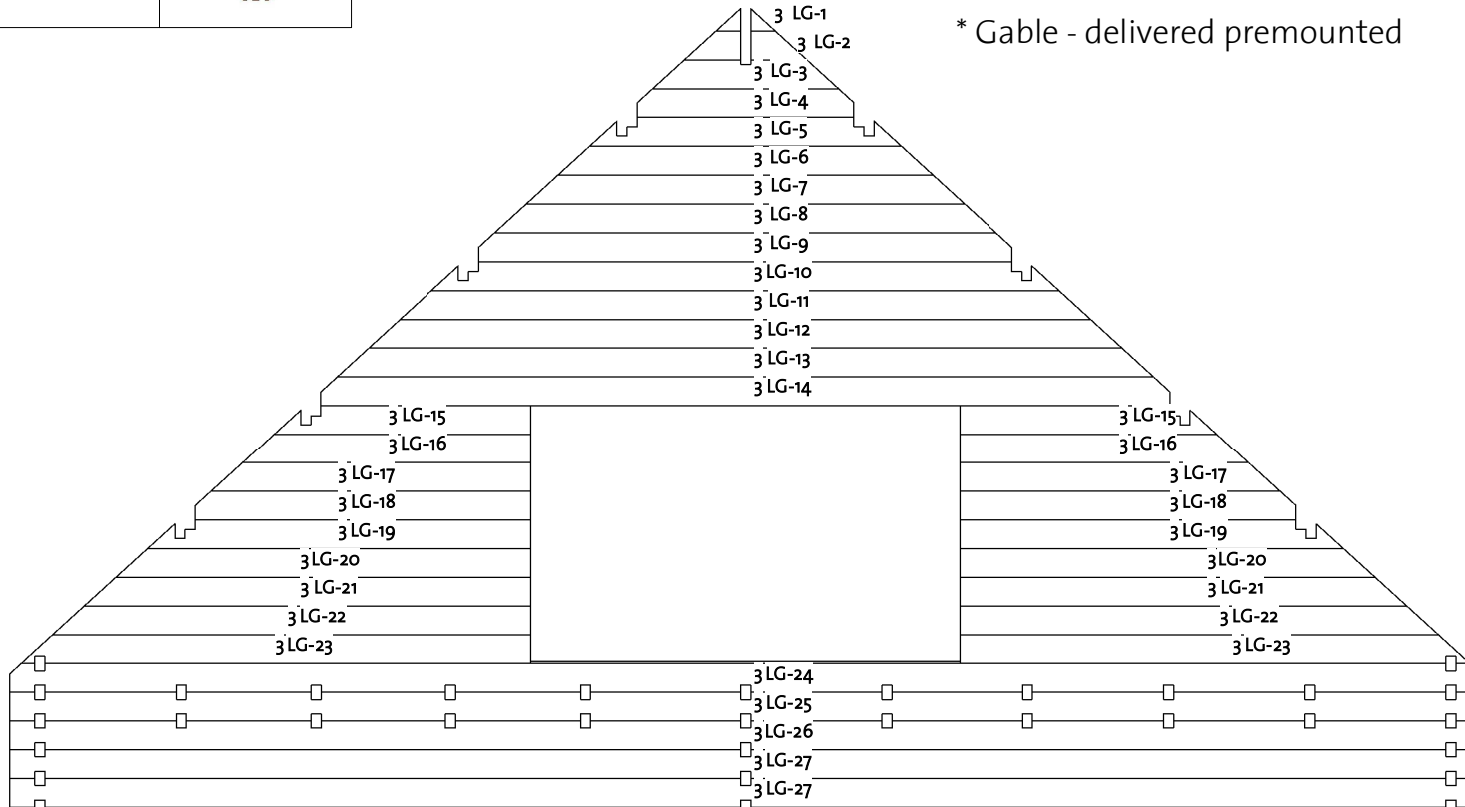

Wall 3			
Mark	Profile	Count	Cut Length

3LG-1 *	40X114	1	9 1/4"
3LG-2 *	40X114	1	19 1/8"
3LG-3 *	40X114	1	29"
3LG-4 *	40X114	1	33 3/4"
3LG-5 *	40X114	1	48 5/8"
3LG-6 *	40X114	1	58 1/2"
3LG-7 *	40X114	1	68 3/8"
3LG-8 *	40X114	1	78 1/4"
3LG-9 *	40X114	1	83 1/4"
3LG-10 *	40X114	1	98"
3LG-11 *	40X114	1	107 7/8"
3LG-12 *	40X114	1	117 3/4"
3LG-13 *	40X114	1	127 5/8"
3LG-14 *	40X114	1	132 3/4"
3LG-15 *	40X114	2	40 1/4"
3LG-16 *	40X114	2	45 1/8"
3LG-17 *	40X114	2	50 1/8"
3LG-18 *	40X114	2	52 1/2"
3LG-19 *	40X114	2	60"
3LG-20 *	40X114	2	64 7/8"
3LG-21 *	40X114	2	69 7/8"
3LG-22 *	40X114	2	74 3/4"
3LG-23 *	40X114	2	79 5/8"
3LG-24 *	40X114	1	229 7/8"
3LG-25	40X114	1	229 7/8"
3LG-26	40X114	1	229 7/8"
3LG-27	40X114	2	229 7/8"

Rivercrest 40 (222"x222")

Wall 4

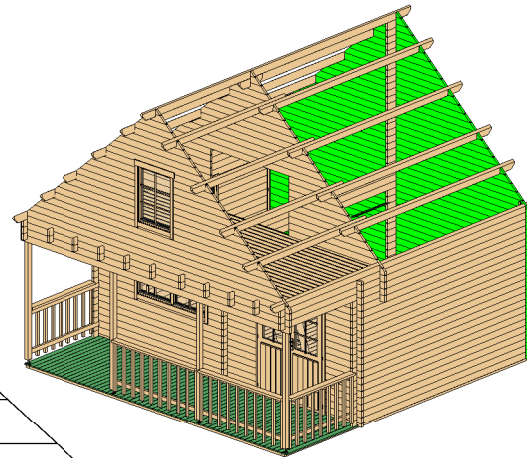

Log Profile Wall 4	
Profile	Profile

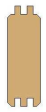
40X57	
40X114	

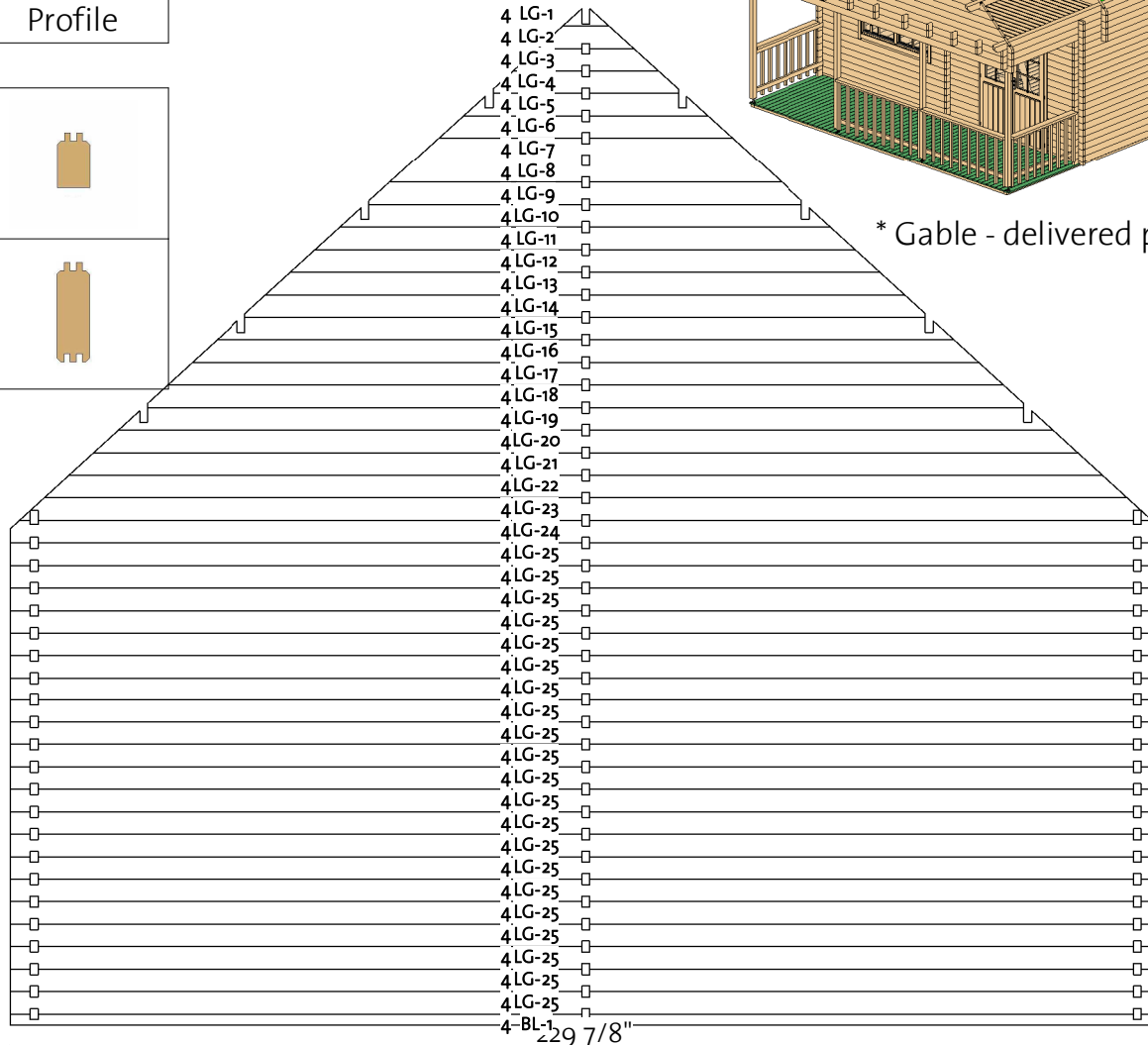

Wall 4			
Mark	Profile	Count	Cut Length

4BL-1	40X57	1	229 7/8"
4LG-1 *	40X114	1	9 1/4"
4LG-2 *	40X114	1	19 1/8"
4LG-3 *	40X114	1	29"
4LG-4 *	40X114	1	36 7/8"
4LG-5 *	40X114	1	48 5/8"
4LG-6 *	40X114	1	58 1/2"
4LG-7 *	40X114	1	68 3/8"
4LG-8 *	40X114	1	78 1/4"
4LG-9 *	40X114	1	86 3/8"
4LG-10 *	40X114	1	98"
4LG-11 *	40X114	1	107 7/8"
4LG-12 *	40X114	1	117 3/4"
4LG-13 *	40X114	1	127 5/8"
4LG-14 *	40X114	1	135 7/8"
4LG-15 *	40X114	1	147 3/8"
4LG-16 *	40X114	1	157 1/4"
4LG-17 *	40X114	1	167 1/8"
4LG-18 *	40X114	1	175 1/8"
4LG-19 *	40X114	1	186 7/8"
4LG-20 *	40X114	1	196 3/4"
4LG-21 *	40X114	1	206 5/8"
4LG-22 *	40X114	1	216 3/8"
4LG-23 *	40X114	1	226 1/4"
4LG-24 *	40X114	1	229 7/8"
4LG-25	40X114	21	229 7/8"

Rivercrest 40 (222"x222")

Wall A

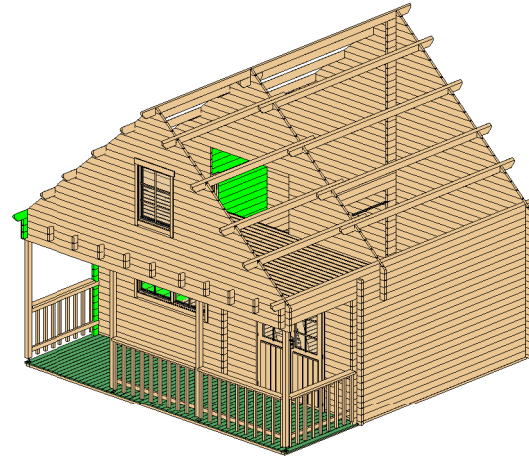

Wall A

Mark	Profile	Count	Cut Length
------	---------	-------	------------

ALG-1	40X114	2	229 7/8"
ALG-3	40X114	1	164"
ALG-4	40X114	18	51 3/4"
ALG-5	40X114	1	164"
ALG-6	40X114	8	164"
ALG-8	40X114	1	229 7/8"
ATL-1	40X143	1	146"
ATL-2	40X143	1	99 5/8"

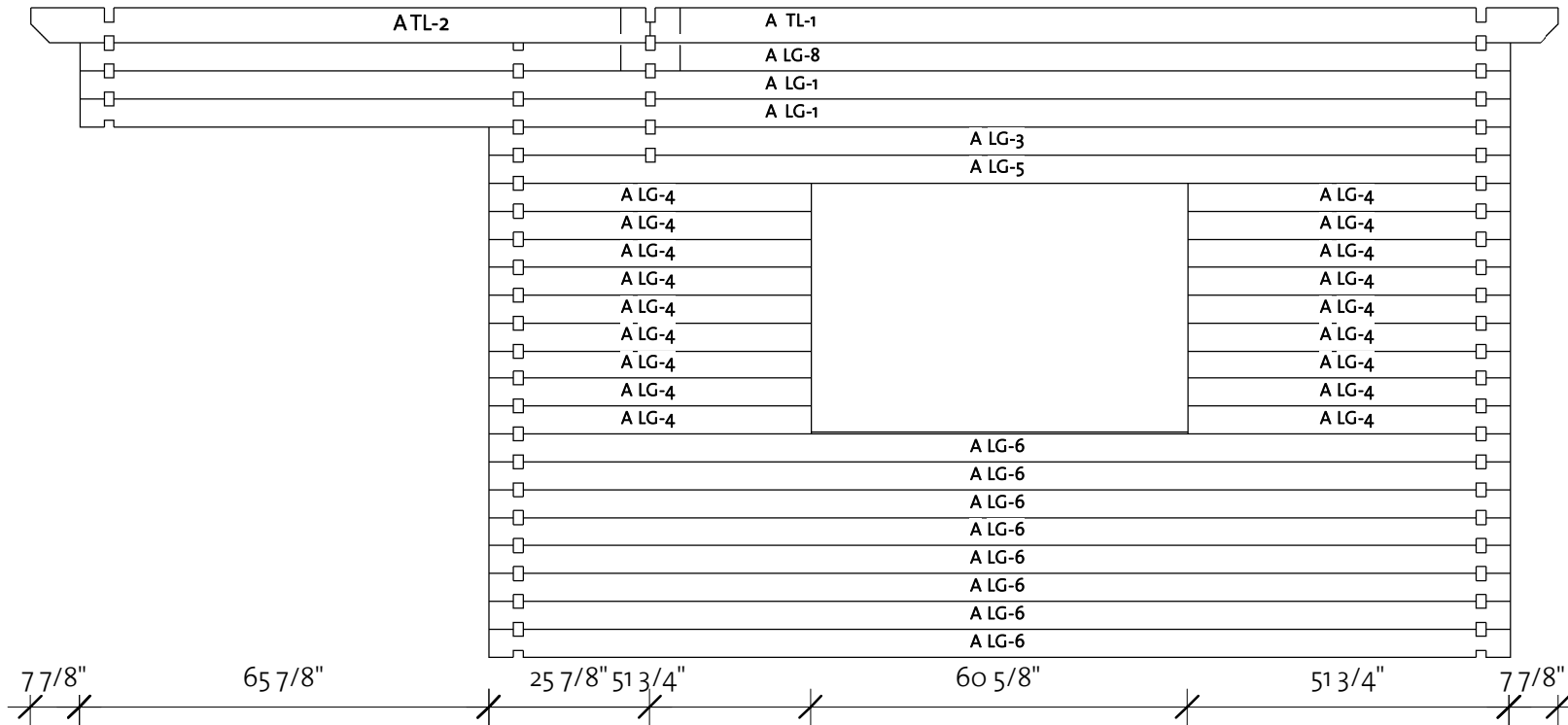

Log Profile Wall A

Profile	Profile
---------	---------

40X114

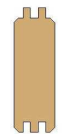

40X143

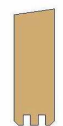

Rivercrest 40 (222" x 222")

Wall B

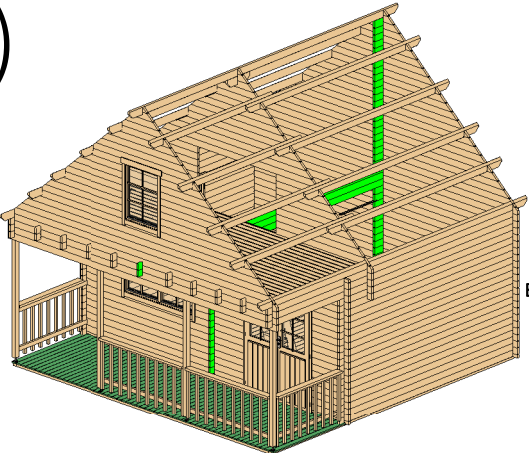

Wall B			
Mark	Profile	Count	Cut Length

BLG-1	4OX114	1	229 7/8"
BLG-2	4OX114	40	13 3/8"
BLG-3	4OX114	1	164"
BLG-4	4OX114	1	30 5/8"
BLG-5	4OX114	1	30 5/8"
BLG-6	4OX114	17	30 5/8"
BLG-7	4OX134	1	13 3/8"
BLG-8	4OX114	1	229 7/8"

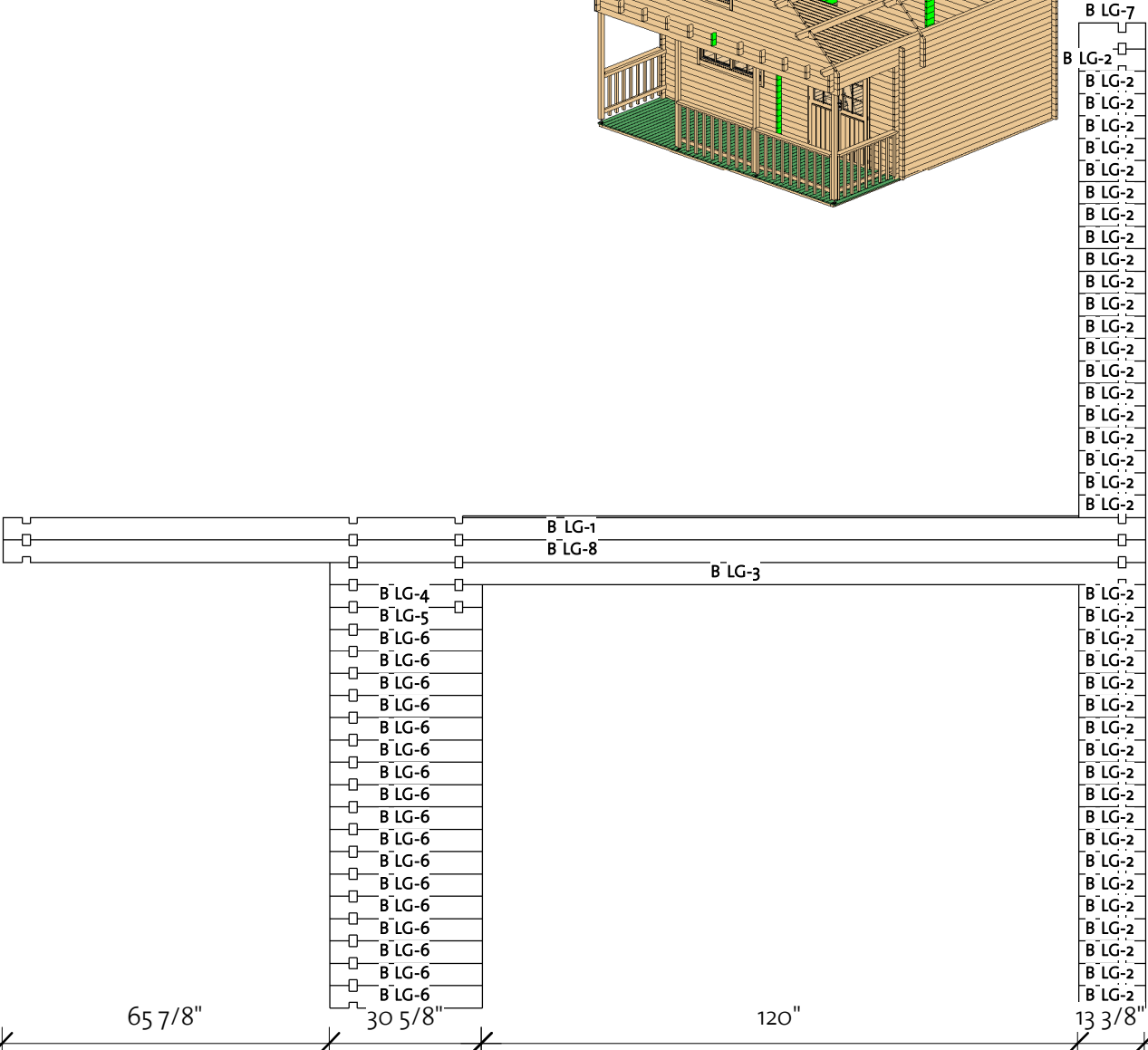

Log Profile Wall B

Profile	Profile
---------	---------

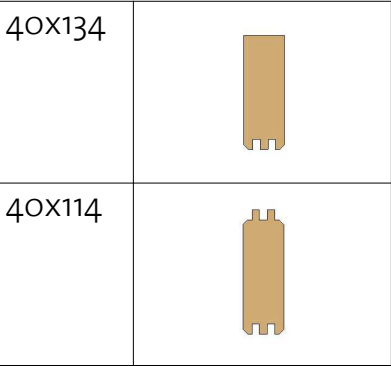

Rivercrest 40 (222"x222")

Wall C

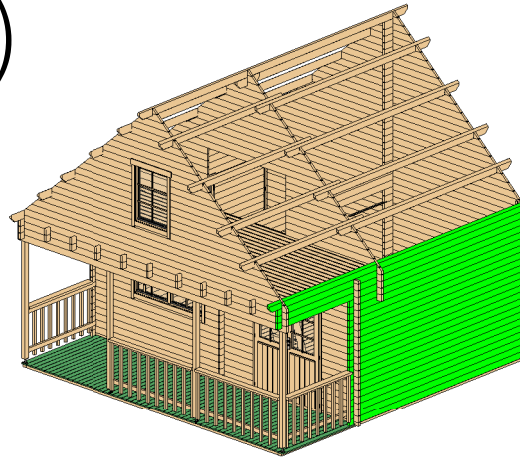

Wall C			
Mark	Profile	Count	Cut Length

CLG-1	40X114	2	229 7/8"
CLG-2	40X114	1	164"
CLG-3	40X114	1	164"
CLG-4	40X114	17	164"
CLG-5	40X114	1	229 7/8"
CTL-1	40X143	1	146"
CTL-2	40X143	1	99 5/8"

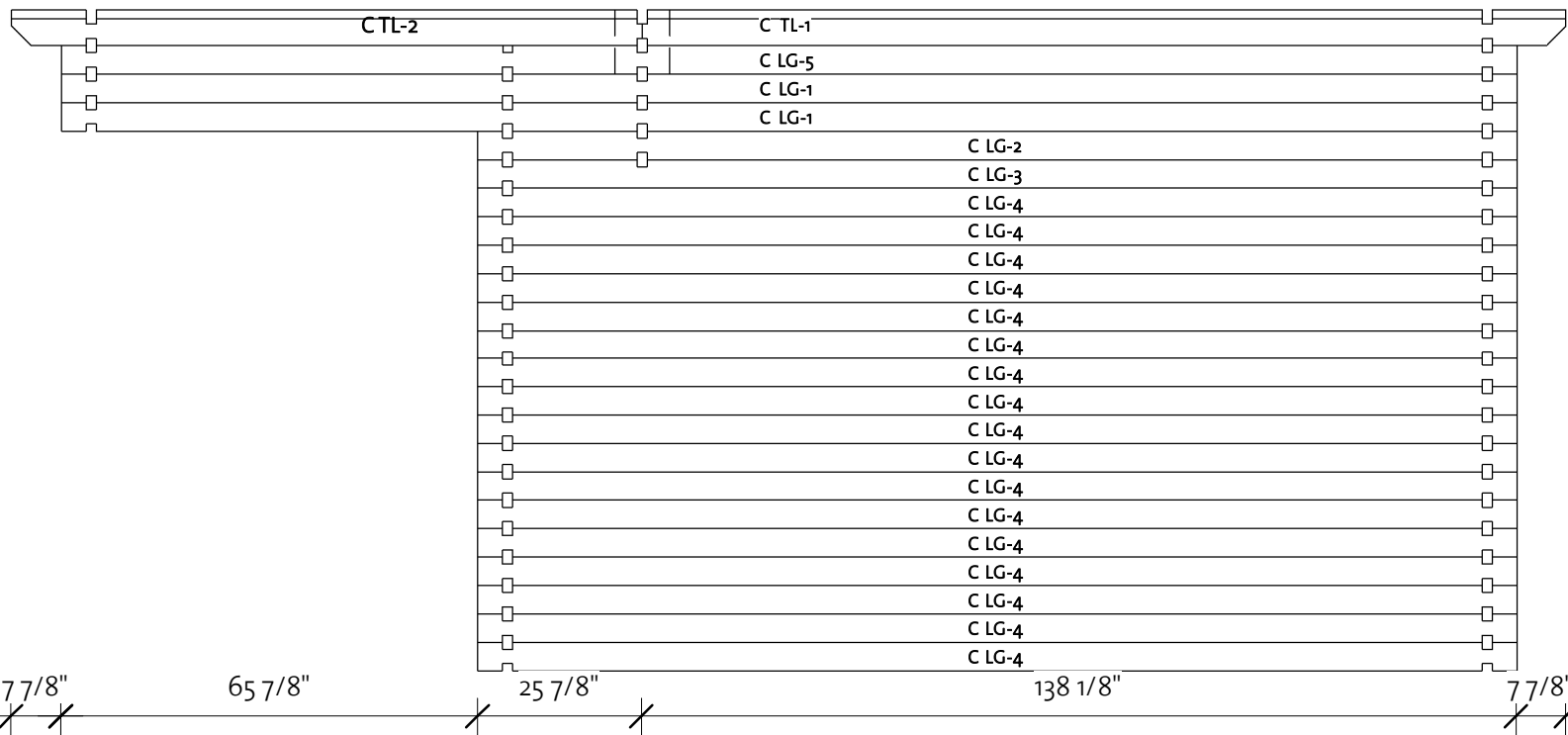

Log Profile Wall C

Profile	Profile
---------	---------

40X114

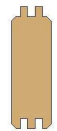



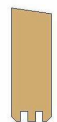

40X143

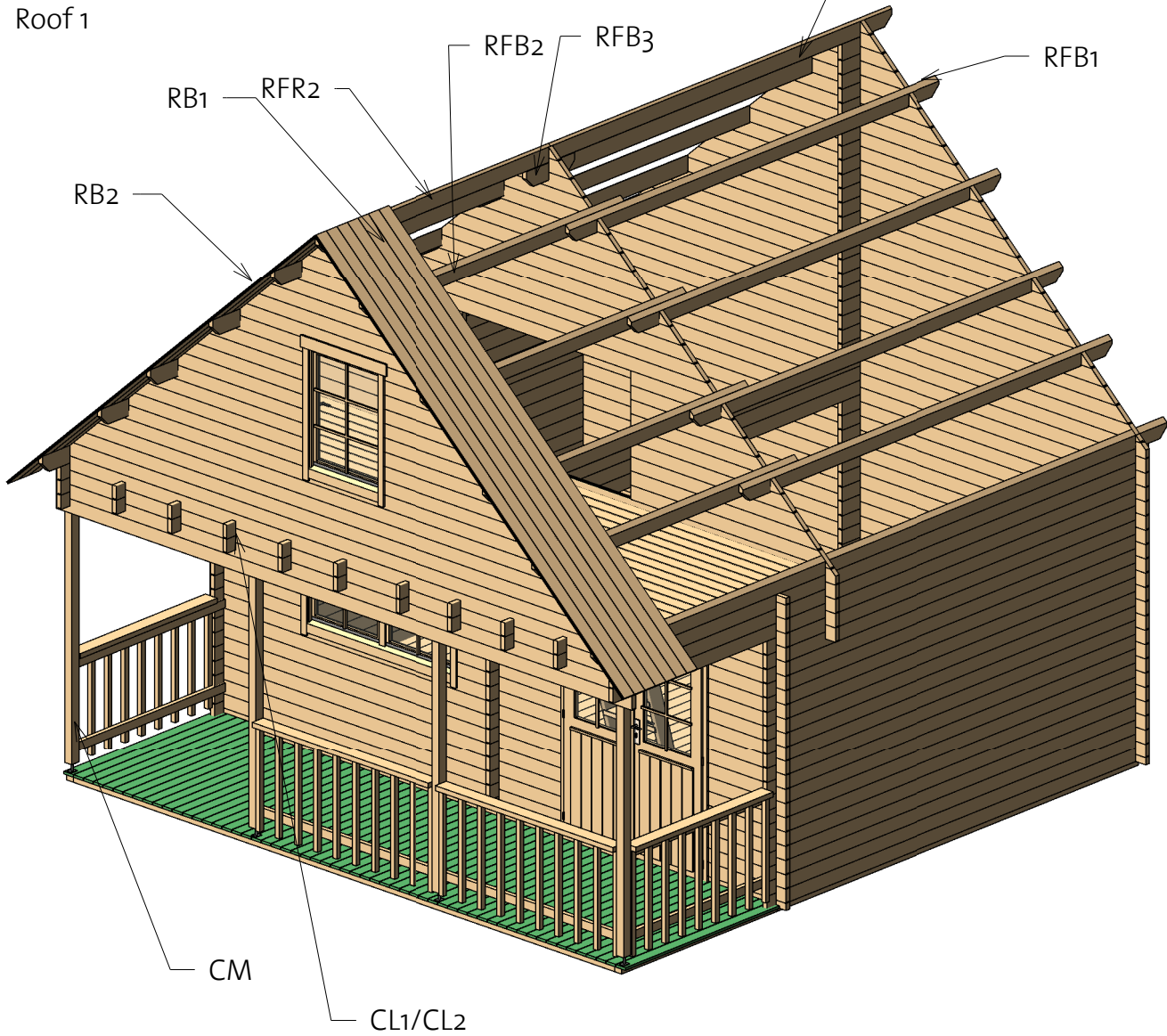

Rivercrest 40 (222"x222")



Roof				
Mark	Type	Profile	Count	Length

RB1	17x114		55	165 7/8"
RB2	17x114		55	166 1/2"
RFB1	Beam 40x143		8	158 5/8"
RFB2	Beam 40x143		8	112 1/4"
RFB3	Ridge 40x143		1	20 1/2"
RFR1	Ridge 40x143		1	146"
RFR2	Ridge 40x143		1	99 5/8"

Rivercrest 40 (222"x222")

Roof 2

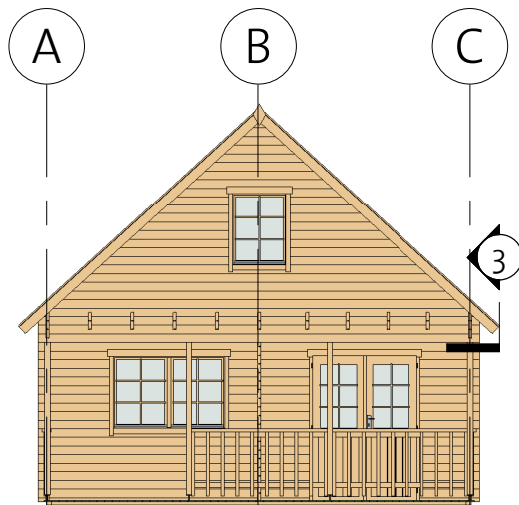
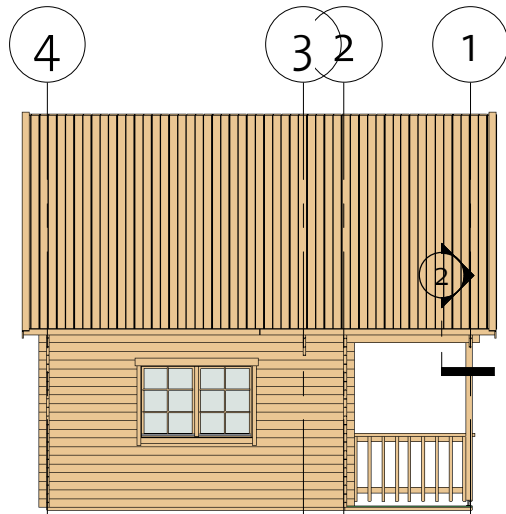

② Facia

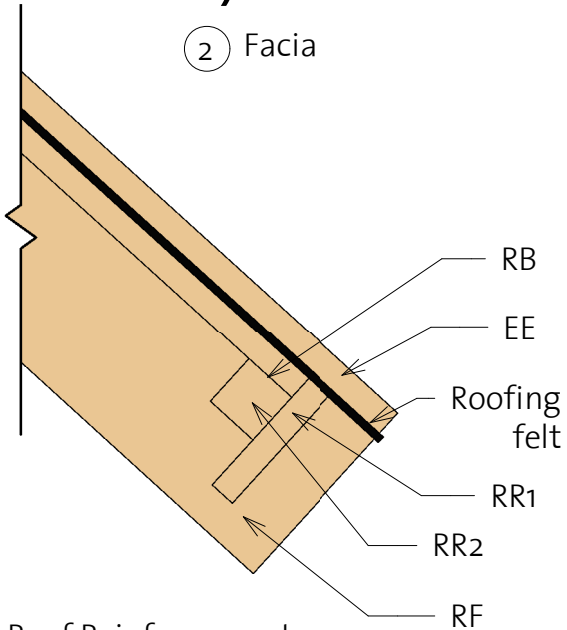

③ Roof Reinforcement

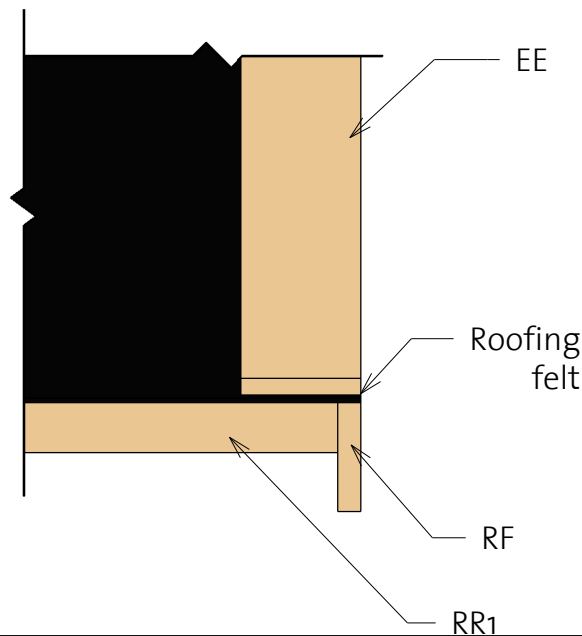

Fascia Schedule





Mark	Type	Profile	Count	Length
EE	Eave Edging 18x95		4	168 7/8"
RF	Roof Fascia 18x120		4	168 7/8"
RR1	Roof reinforce ment 18x95		4	122 7/8"
RR2	Roof reinforce ment 38x38		4	122 7/8"

Rivercrest 40 (222"x222")

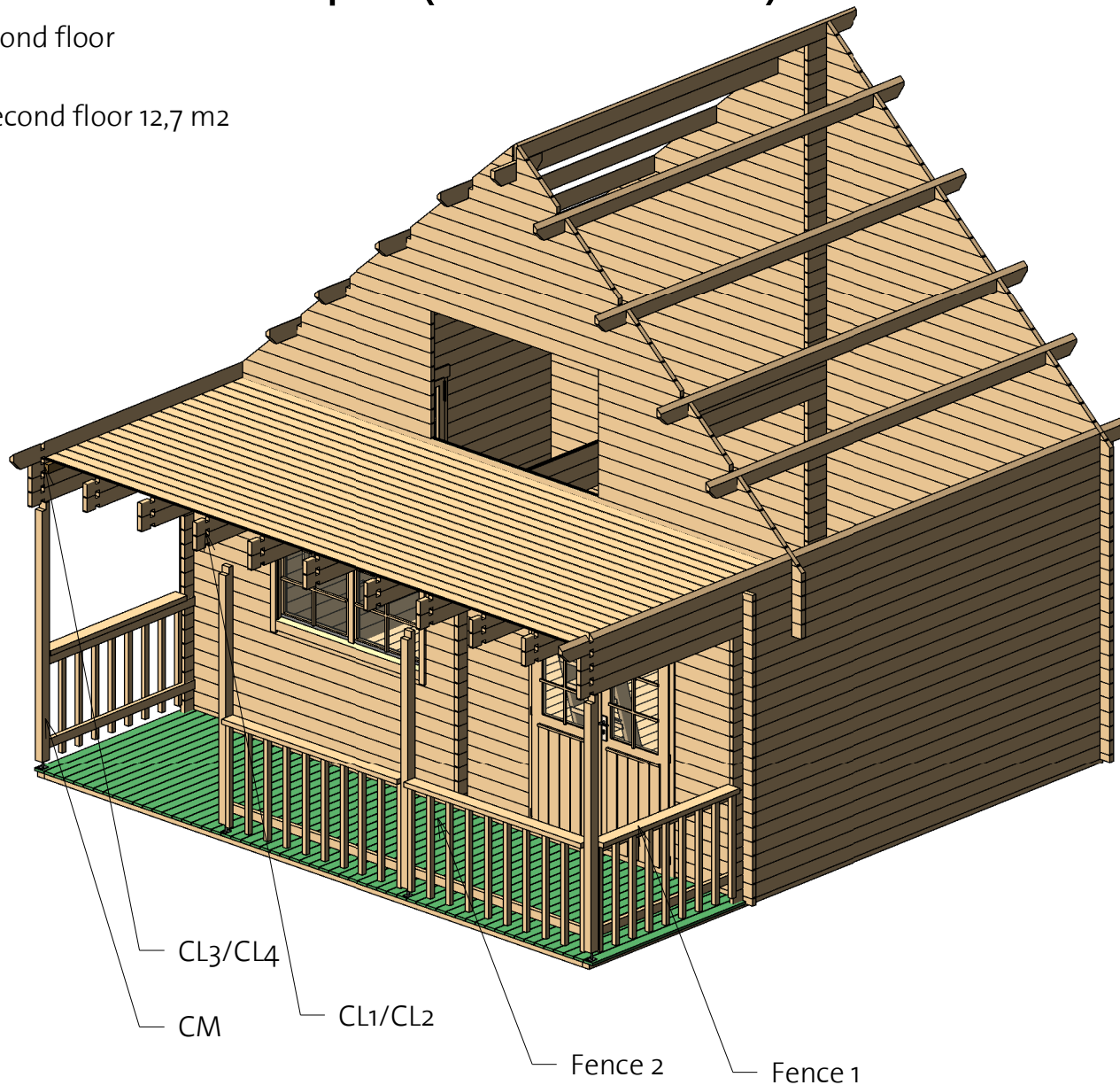
Second floor

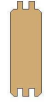
Second floor 12,7 m²



Second floor schedule				
Mark	Type	Profile	Count	Length
CL1	Log 40x114		8	96 1/2"
CL2	Log 40x114		8	96 1/2"
CL3	Beam 40x70		2	64 1/4"
CL4	Beam 40x70		2	19 5/8"



Columns			
Mark	Profile	Count	Length
CM	Post 80x70	4	81 1/2"

Fence Schedule		
Type	Length	Count
Fence1	62 3/4"	2
Fence2	70 3/4"	2

Rivercrest 40 (222"x222")

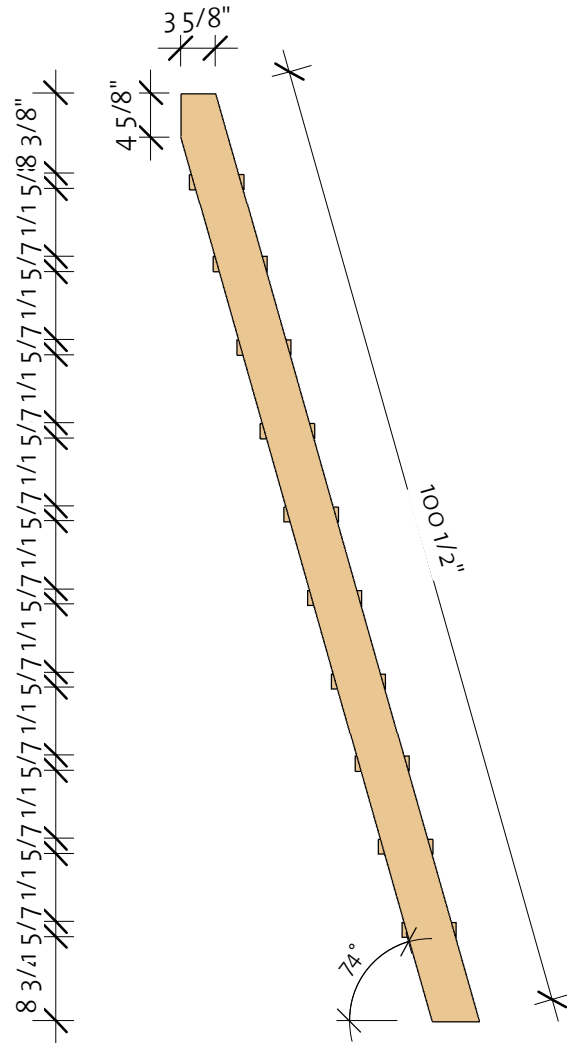
Stair



Stairs				
Mark	Profile	Profile	Count	Cut Length
ST1L	Stair 40X120		1	101 1/2"
ST1R	Stair 40X120		1	101 1/2"
ST2	Stair 40X143		10	20 1/2"

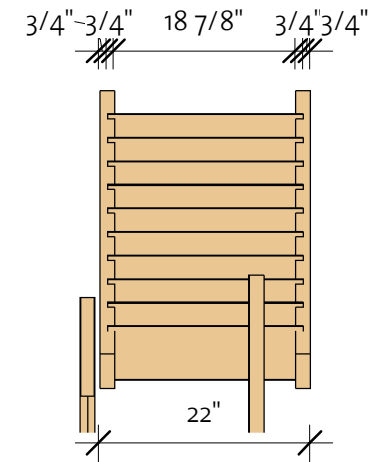

Rivercrest 40 (222"x222")

Extras

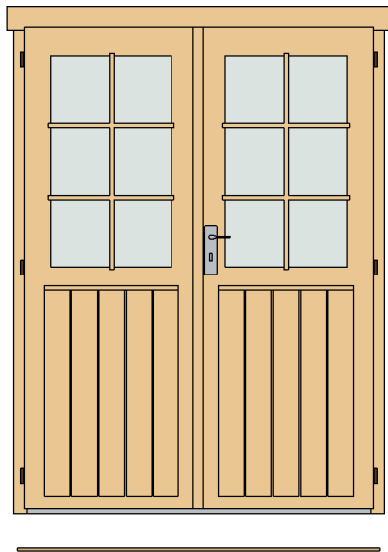

Door Schedule				
Model	Type	Width	Height	Count
CDD1R	Classic double door 1 right	56 1/8"	77"	1
DCB6	Door Crossbar 6	--	--	1/8"
DB	Door beam 1440 mm	40	12	1

Type	Count	Length
Windboard 18x40	2	102 3/8"
Windboard 18x40 2	2	86 5/8"

Type	Count
Romb	2



Fasteners/Extras		
Name	Type	Count

Hitblock	300-400 mm	
Adjustable post foot		4
Dowels	16,0x150	8
Bolts	M8x70	12
Nails	1,4 x 40	65
Screws	5,0 x 70	110
Screws	6,0 x 140	120
Screws	4,0 x 40	2100

Window Schedule				
Mark	Type	Width	Height	Count
CDW1	Classic double window 1	60 1/4"	39"	2
CW1L	Classic window 1 left	30 1/8"	39"	1
WCB6	Windows Crossbar 6	--	--	5

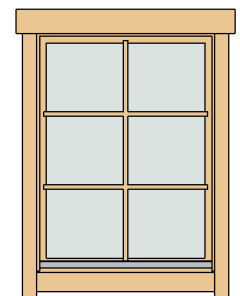
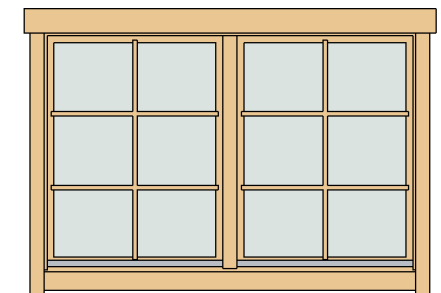





Rivercrest 40 (222"x222")

List of all items 1



Impregnated foundation beams

Mark	Type	Profile	Count	Length
IFB1	IFB 70x40		12	216 1/8"
IFB2	IFB 70x40		2	66 5/8"
IFB3	IFB 70x40		2	155 1/4"

Roof

Mark	Type	Profile	Count	Length
RB1	17x114		55	165 7/8"
RB2	17x114		55	166 1/2"
RFB1	Beam 40x143		8	158 5/8"
RFB2	Beam 40x143		8	112 1/4"
RFB3	Ridge 40x143		1	20 1/2"
RFR1	Ridge 40x143		1	146"
RFR2	Ridge 40x143		1	99 5/8"





Floor Schedule

Mark	Type	Profile	Count	Length
FB1	FB 17x114		49	152 3/4"
FB2	FB 17x114		19	218 3/4"
BB 1	BB 18x40		5	220 1/2"

Terrace Schedule

Mark	Type	Profile	Count	Length
TB	TB 21x95		57	65 7/8"

Fascia Schedule

Mark	Type	Profile	Count	Length
EE	Eave Edging 18x95		4	168 7/8"
RF	Roof Fascia 18x120		4	168 7/8"
RR1	Roof reinforce ment 18x95		4	122 7/8"
RR2	Roof reinforce ment 38x38		4	122 7/8"

Rivercrest 40 (222"x222")

List of all items 2

Wall 1			
Mark	Profile	Count	Cut Length

1LG-1 *	40X114	1	9 1/4"
1LG-2 *	40X114	1	19 1/8"
1LG-3 *	40X114	1	29"
1LG-4 *	40X114	1	38 7/8"
1LG-5 *	40X114	1	48 5/8"
1LG-6 *	40X114	1	58 1/2"
1LG-7 *	40X114	1	68 3/8"
1LG-8 *	40X114	1	78 1/4"
1LG-9 *	40X114	1	88 1/8"
1LG-10 *	40X114	2	33 7/8"
1LG-11 *	40X114	2	38 3/4"
1LG-12 *	40X114	2	43 3/4"
1LG-13 *	40X114	2	48 5/8"
1LG-14 *	40X114	2	53 5/8"
1LG-15 *	40X114	2	58 1/2"
1LG-16 *	40X114	2	63 1/2"
1LG-17 *	40X114	2	68 3/8"
1LG-18 *	40X114	2	73 3/8"
1LG-19 *	40X114	1	186 7/8"
1LG-20 *	40X114	1	196 3/4"
1LG-21 *	40X114	1	206 5/8"
1LG-22 *	40X114	1	216 3/8"
1LG-23 *	40X114	1	226 1/4"
1LG-24 *	40X114	1	229 7/8"
1LG-25	40X114	1	229 7/8"
1LG-26	40X114	1	229 7/8"
1LG-27	40X114	1	229 7/8"

Wall 2			
Mark	Profile	Count	Cut Length

2BL-1	40X57	1	31 5/8"
2BL-2	40X57	1	141 5/8"
2LG-1	40X114	9	43 1/4"
2LG-2	40X114	9	37 5/8"
2LG-3	40X114	17	31 5/8"
2LG-4	40X114	1	229 7/8"
2LG-5	40X114	8	141 5/8"
2LG-6	40X57	1	229 7/8"
2LG-7	40X114	1	229 7/8"
2LG-8	40X114	1	229 7/8"
2LG-9	40X114	1	229 7/8"

* Gable - delivered premounted

Wall A			
Mark	Profile	Count	Cut Length

ALG-1	40X114	2	229 7/8"
ALG-3	40X114	1	164"
ALG-4	40X114	18	51 3/4"
ALG-5	40X114	1	164"
ALG-6	40X114	8	164"
ALG-8	40X114	1	229 7/8"
ATL-1	40X143	1	146"
ATL-2	40X143	1	99 5/8"

Rivercrest 40 (222"x222")

List of all items 3

Wall 3			
Mark	Profile	Count	Cut Length

3LG-1 *	40X114	1	9 1/4"
3LG-2 *	40X114	1	19 1/8"
3LG-3 *	40X114	1	29"
3LG-4 *	40X114	1	33 3/4"
3LG-5 *	40X114	1	48 5/8"
3LG-6 *	40X114	1	58 1/2"
3LG-7 *	40X114	1	68 3/8"
3LG-8 *	40X114	1	78 1/4"
3LG-9 *	40X114	1	83 1/4"
3LG-10 *	40X114	1	98"
3LG-11 *	40X114	1	107 7/8"
3LG-12 *	40X114	1	117 3/4"
3LG-13 *	40X114	1	127 5/8"
3LG-14 *	40X114	1	132 3/4"
3LG-15 *	40X114	2	40 1/4"
3LG-16 *	40X114	2	45 1/8"
3LG-17 *	40X114	2	50 1/8"
3LG-18 *	40X114	2	52 1/2"
3LG-19 *	40X114	2	60"
3LG-20 *	40X114	2	64 7/8"
3LG-21 *	40X114	2	69 7/8"
3LG-22 *	40X114	2	74 3/4"
3LG-23 *	40X114	2	79 5/8"
3LG-24 *	40X114	1	229 7/8"
3LG-25	40X114	1	229 7/8"
3LG-26	40X114	1	229 7/8"
3LG-27	40X114	2	229 7/8"





Wall 4			
Mark	Profile	Count	Cut Length

4BL-1	40X57	1	229 7/8"
4LG-1 *	40X114	1	9 1/4"
4LG-2 *	40X114	1	19 1/8"
4LG-3 *	40X114	1	29"
4LG-4 *	40X114	1	36 7/8"
4LG-5 *	40X114	1	48 5/8"
4LG-6 *	40X114	1	58 1/2"
4LG-7 *	40X114	1	68 3/8"
4LG-8 *	40X114	1	78 1/4"
4LG-9 *	40X114	1	86 3/8"
4LG-10 *	40X114	1	98"
4LG-11 *	40X114	1	107 7/8"
4LG-12 *	40X114	1	117 3/4"
4LG-13 *	40X114	1	127 5/8"
4LG-14 *	40X114	1	135 7/8"
4LG-15 *	40X114	1	147 3/8"
4LG-16 *	40X114	1	157 1/4"
4LG-17 *	40X114	1	167 1/8"
4LG-18 *	40X114	1	175 1/8"
4LG-19 *	40X114	1	186 7/8"
4LG-20 *	40X114	1	196 3/4"
4LG-21 *	40X114	1	206 5/8"
4LG-22 *	40X114	1	216 3/8"
4LG-23 *	40X114	1	226 1/4"
4LG-24 *	40X114	1	229 7/8"
4LG-25	40X114	21	229 7/8"

Rivercrest 40 (222"x222")

List of all items 4

Log profiles	
Profile	Profile

40X57	
40X57	
40X114	
40X114	
40X134	





Fence Schedule		
Type	Length	Count

Fence1	62 3/4"	2
Fence2	70 3/4"	2



Columns			
Mark	Profile	Count	Length

CM	Post 80x70	4	81 1/2"
----	------------	---	---------

Second floor schedule				
Mark	Type	Profile	Count	Length

CL1	Log 40X114		8	96 1/2"
CL2	Log 40X114		8	96 1/2"
CL3	Beam 40X70		2	64 1/4"
CL4	Beam 40X70		2	19 5/8"

Stairs				
Mark	Profile	Profile	Count	Cut Length

ST1L	Stair 40X120		1	101 1/2"
ST1R	Stair 40X120		1	101 1/2"
ST2	Stair 40X143		10	20 1/2"