

# Toronto 160 28 (488x305)

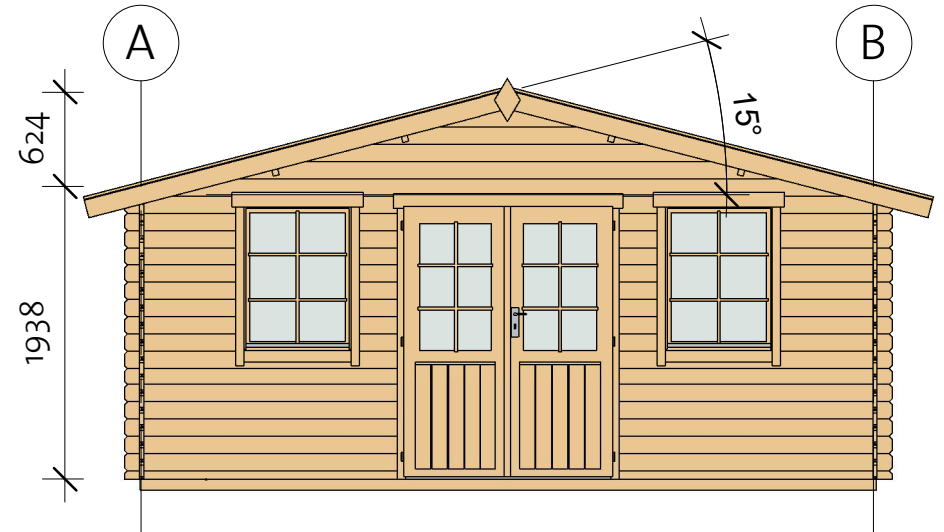

# Toronto 160 28 (488x305)

Foundation

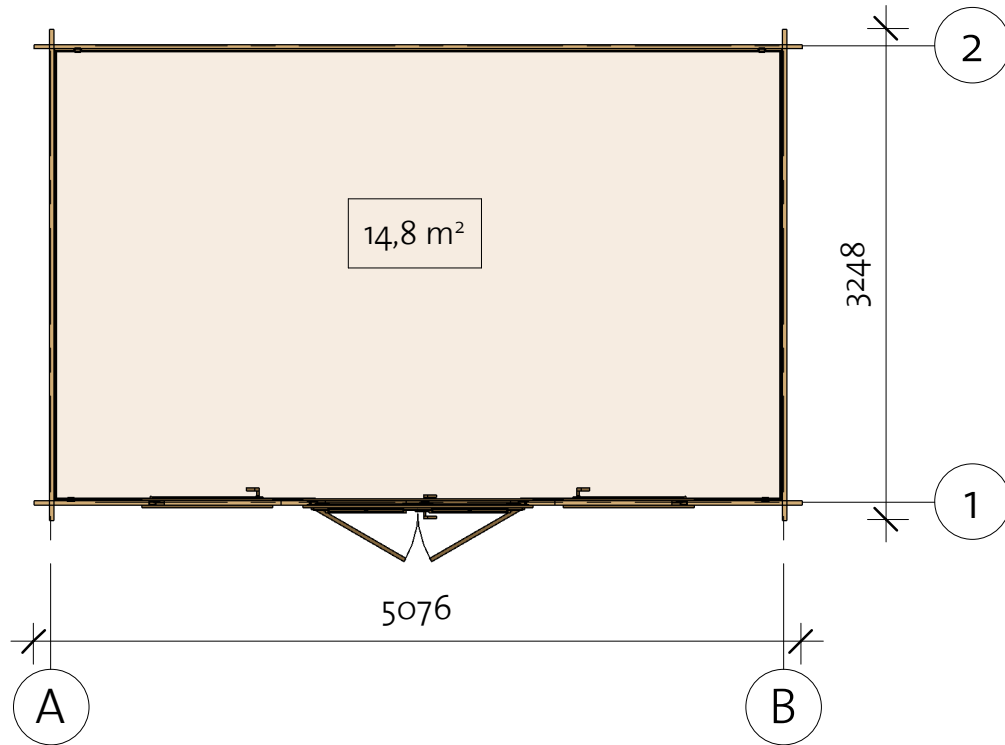
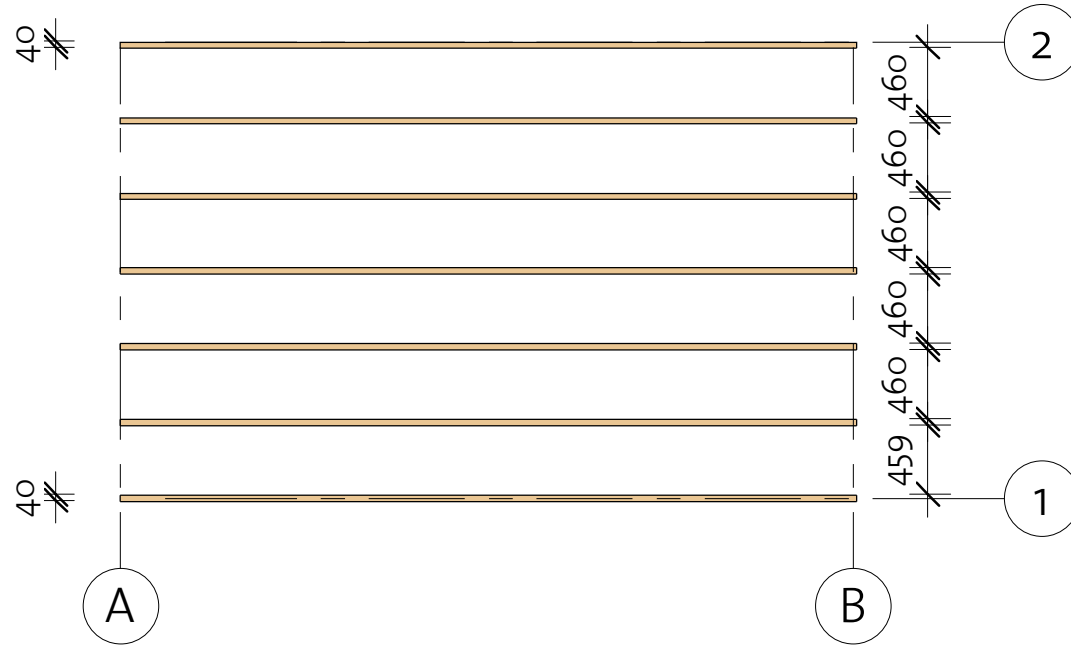

Impregnated foundation beams				
Mark	Type	Profile	Count	Length

IFB	IFB 40x70		7	4866
-----	--------------	---	---	------

# Toronto 160 28 (488x305)

Floor Plan

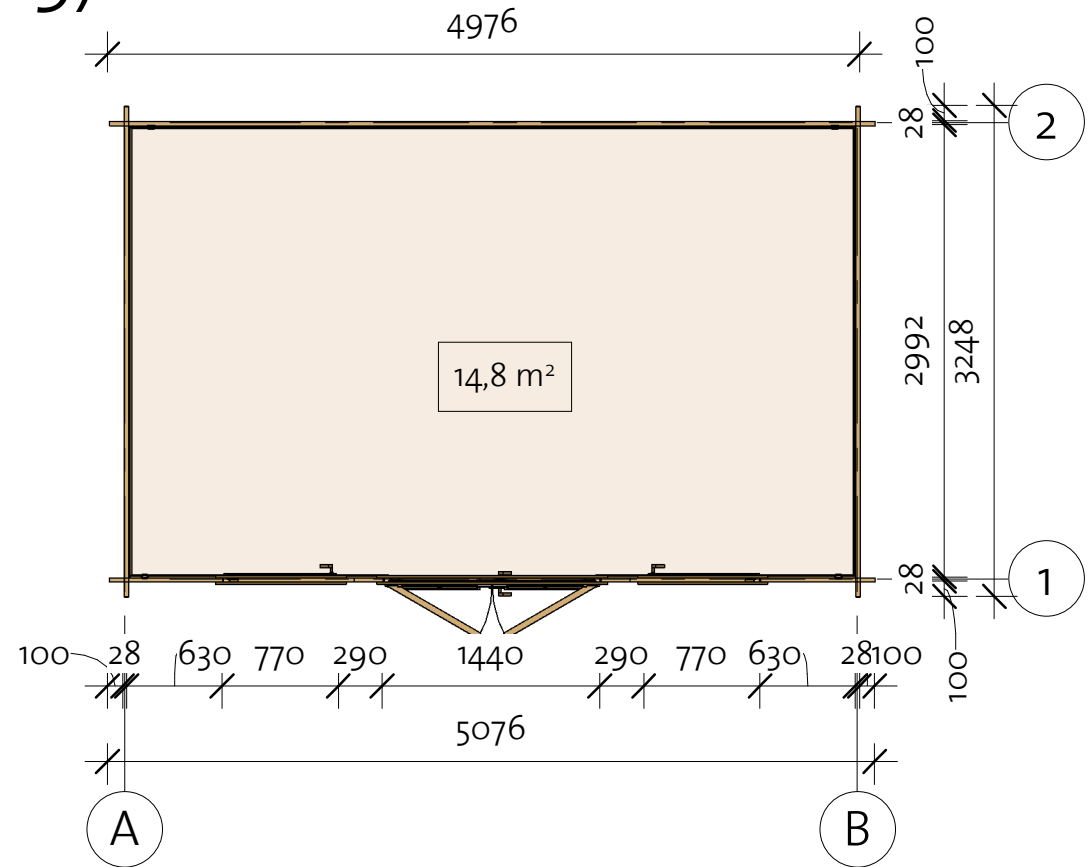
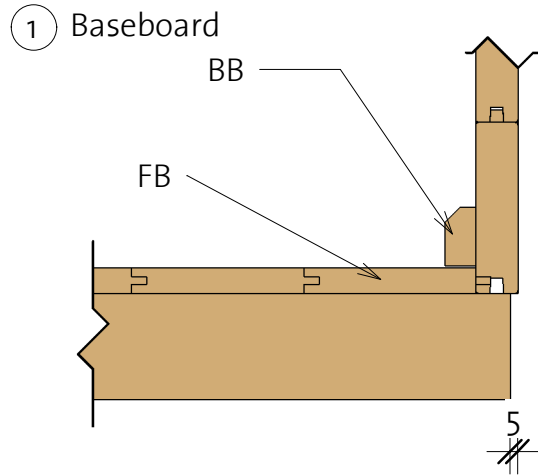

Floor Schedule

Mark	Type	Profile	Count	Length
------	------	---------	-------	--------

FB	FB 17x114		44	2986
BB1	BB 20x40		2	4900
BB2	BB 20x40		2	3100

92309163\_230925

# Toronto 160 28 (488x305)

Wall 1

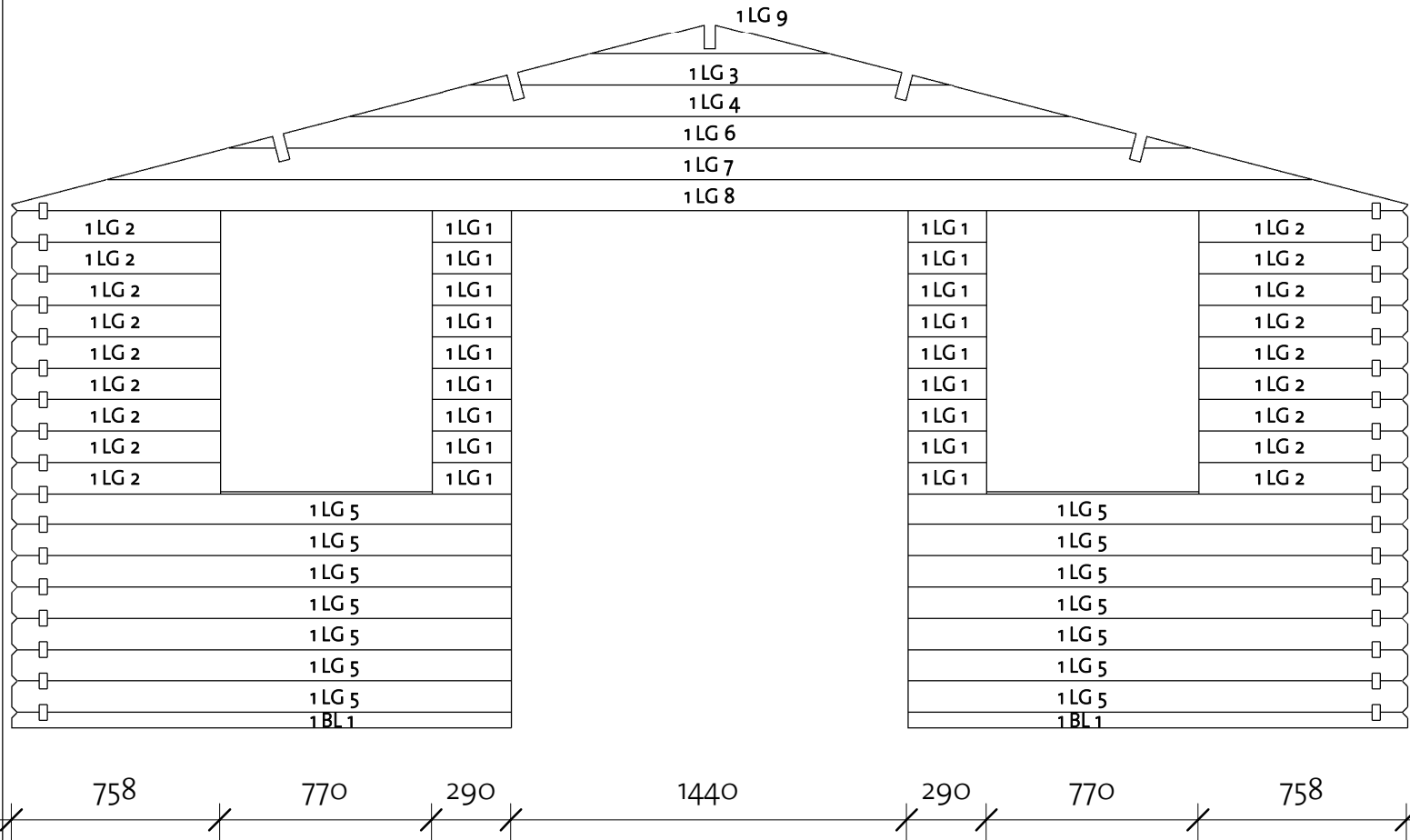
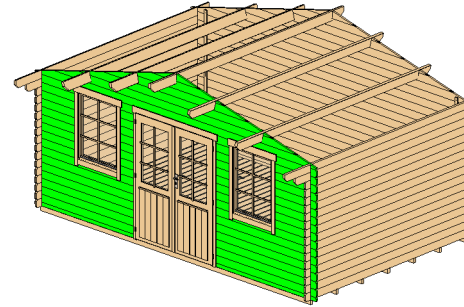

Wall 1			
Mark	Profile	Count	Cut Length

1BL 1	28x57	2	1818
1LG 1	28x114	18	290
1LG 2	28x114	18	758
1LG 3 *	28x114	1	1743
1LG 4 *	28x114	1	2622
1LG 5	28x114	14	1818
1LG 6 *	28x114	1	3501
1LG 7 *	28x114	1	4380
1LG 8 *	28x114	1	5076
1LG 9 *	28x114	1	864

\*Gable-delivered premounted

Log Profile Wall 1	
Profile	Profile

28x57	
28x114	

# Toronto 160 28 (488x305)

Wall 2

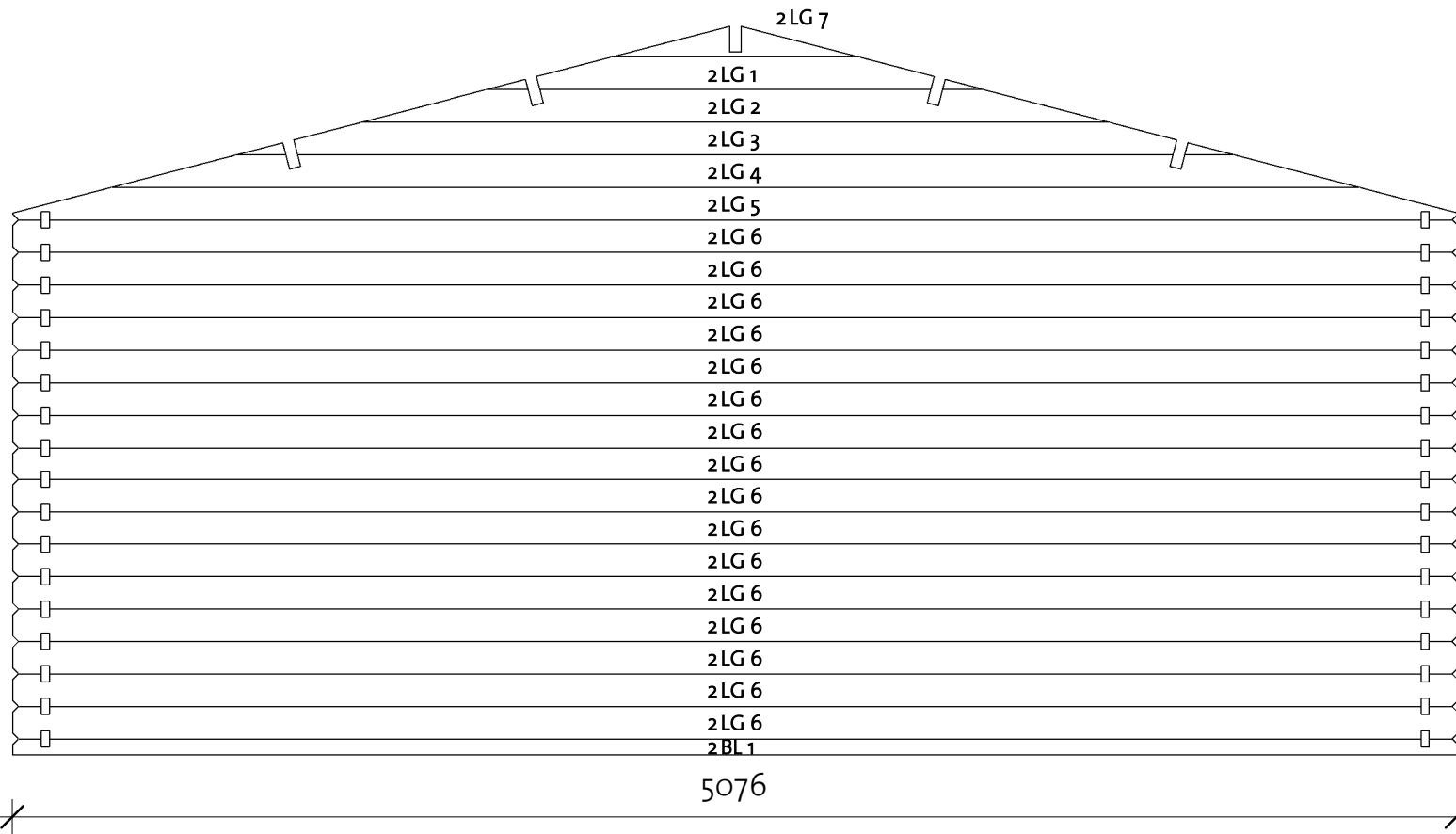
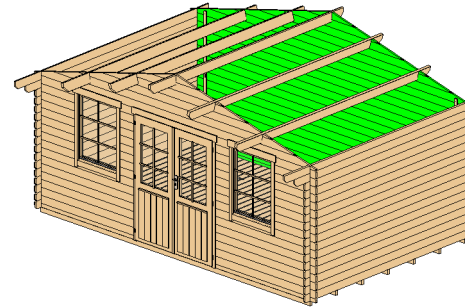



Wall 2			
Mark	Profile	Count	Cut Length

2BL 1	28x57	1	5076
2LG 1 *	28x114	1	1743
2LG 2 *	28x114	1	2622
2LG 3 *	28x114	1	3501
2LG 4 *	28x114	1	4380
2LG 5 *	28x114	1	5076
2LG 6	28x114	16	5076
2LG 7 *	28x114	1	864

\*Gable-delivered premounted

Log Profile Wall 2	
Profile	Profile

28x57	
28x114	

# Toronto 160 28 (488x305)

Wall A

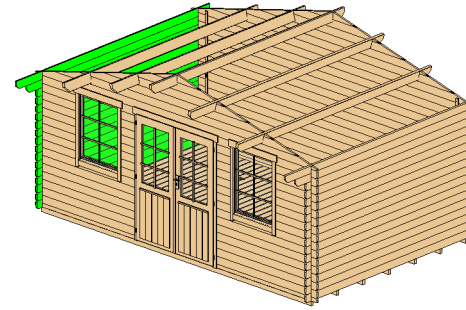

Wall A			
Mark	Profile	Count	Cut Length

ALG 1	28x114	15	3248
ALG 2	28x114	1	3448
ATL 1	28x114	1	3748

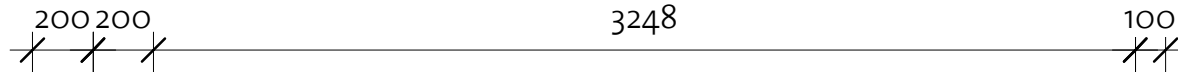
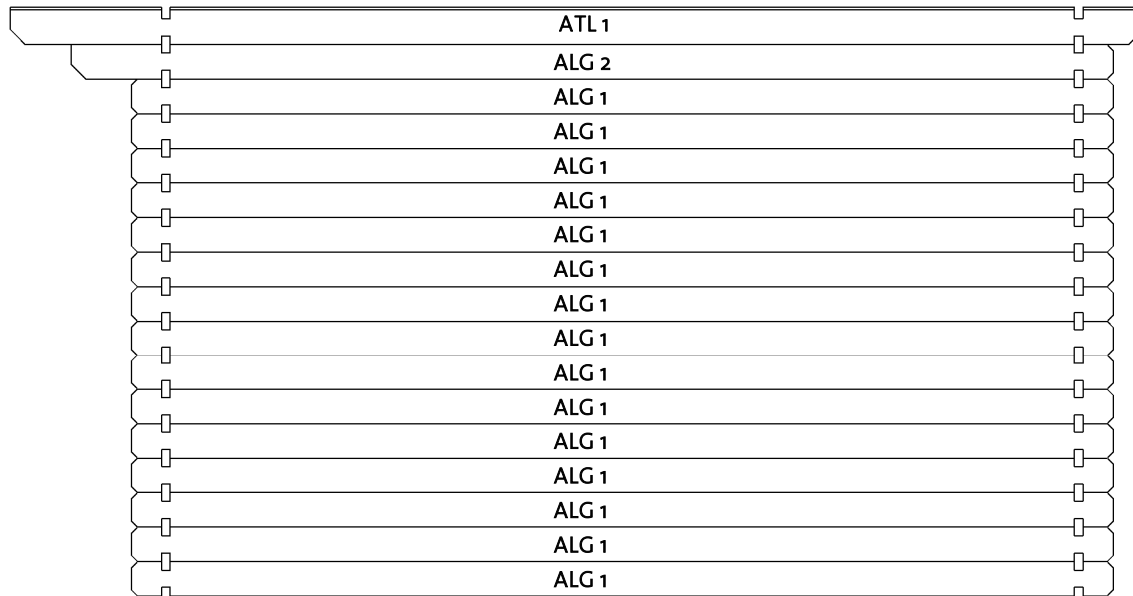

Log Profile Wall A	
Profile	Profile

28x114	
28x114	

# Toronto 160 28 (488x305)

Wall B

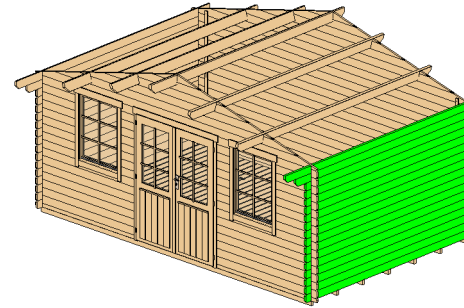

Wall B			
Mark	Profile	Count	Cut Length

BLG 1	28x114	15	3248
BLG 2	28x114	1	3448
BTL-1	28x114	1	3748

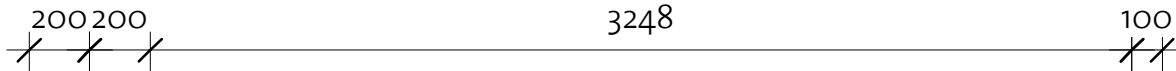
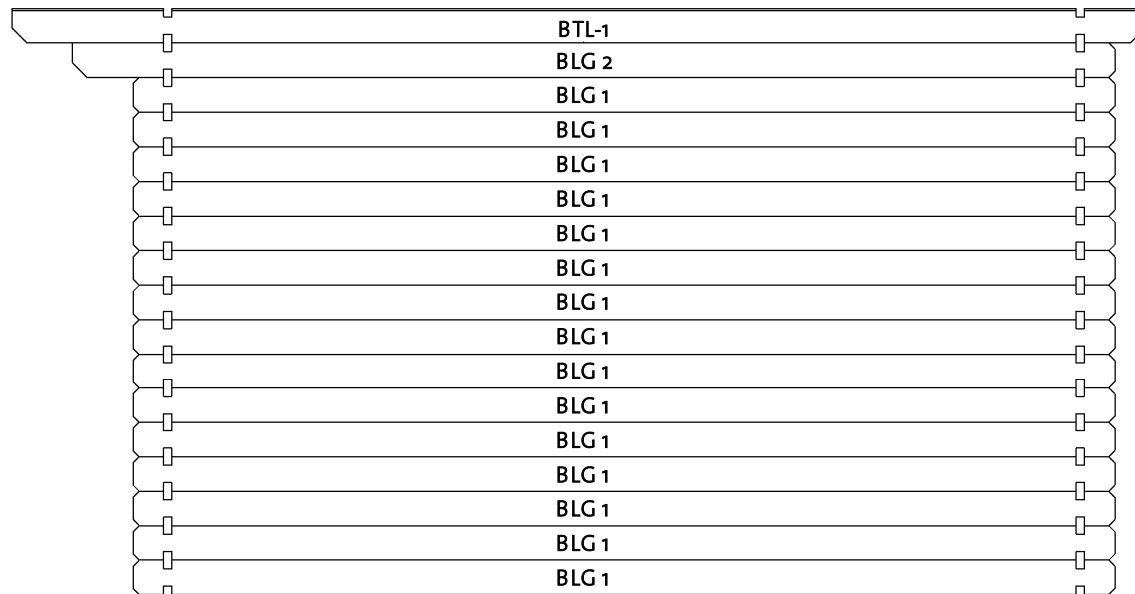





Log Profile Wall B	
Profile	Profile

28x114	
28x114	

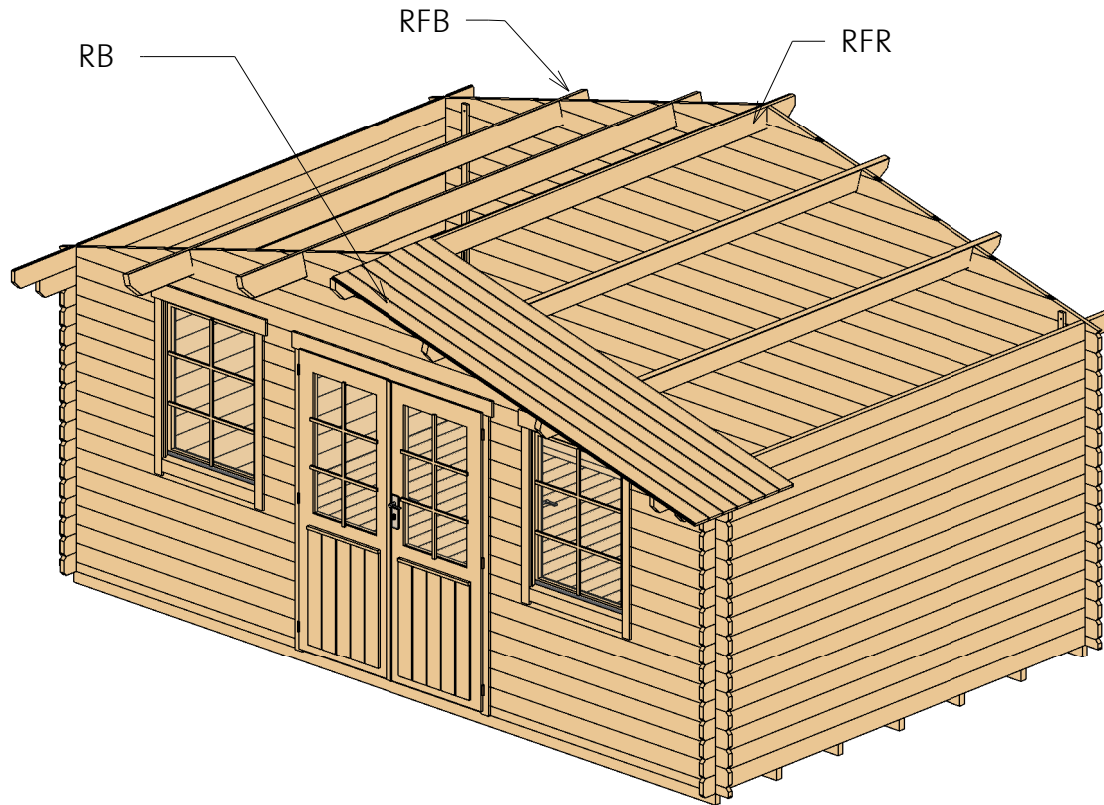
# Toronto 160 28 (488x305)

Roof 1



Roof				
Mark	Type	Profile	Count	Length
RFR	Ridge 40x143		1	3748
RFB	Beam 40x143		4	3748
RB	17x114		68	2846



# Toronto 160 28 (488x305)

Roof 2

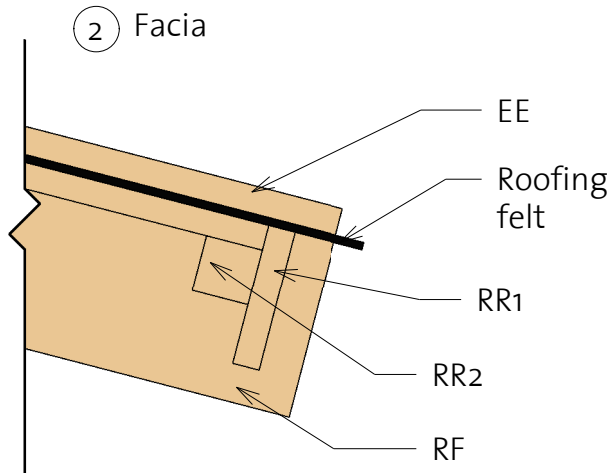
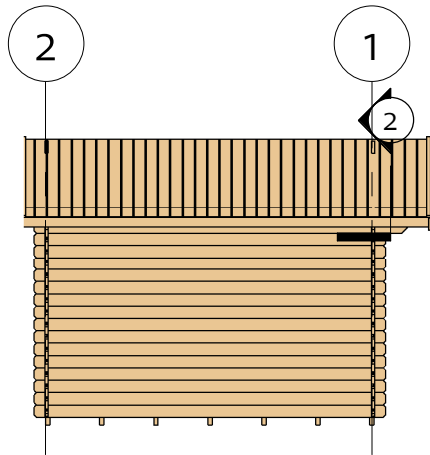

3 Roof Reinforcement

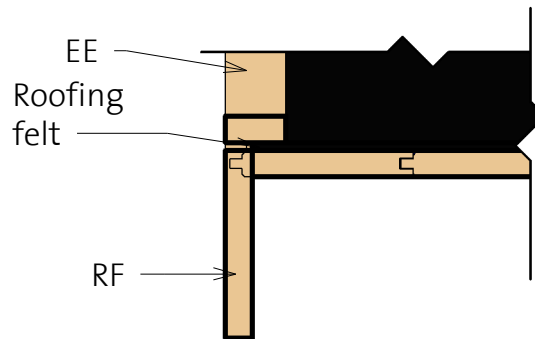
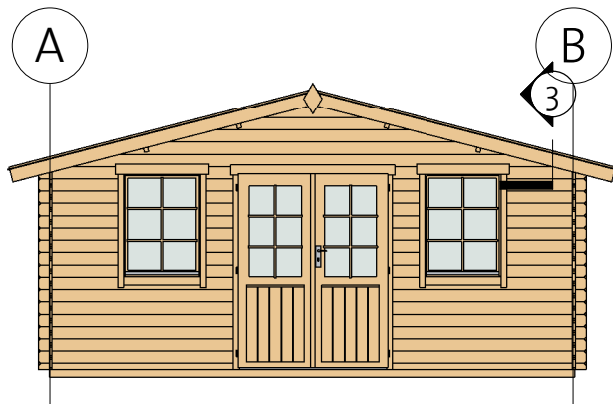

Fascia Schedule				
Mark	Type	Profile	Count	Length

EE	Eave Edging 18x40		4	2896
RF	Roof Fascia 18x120		4	2896
RR1	Roof reinforcement 18x95		2	3748
RR2	Roof reinforcement 38x38		2	3748

# Toronto 160 28 (488x305)

Extras

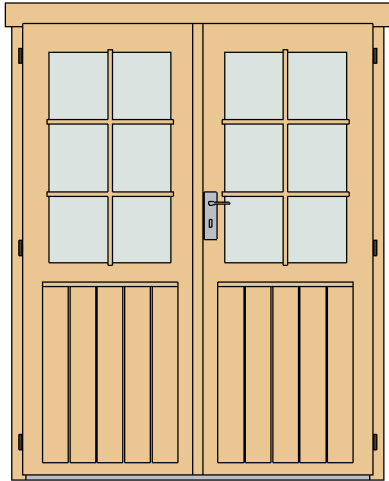

Door Schedule				
Model	Type	Width	Height	Count
BDD5R	Basic double door 5 right	1425	1835	1
DCB6	Door crossbar 6	--	--	2

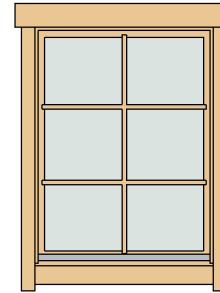

Window Schedule				
Model	Type	Width	Height	Count
BW1R	Basic window 1 right	765	990	1
BW1L	Basic window 1 left	765	990	1
WCB6	Window crossbar 6	--	--	2

Fasteners/Extras		
Name	Type	Count

Hitblock	300-400 mm	
Bolts	M8 x 60	12
Screws	5,0 x 70	15
nails	1,4 x 40	34
Screws	6,0 x 140	40
Screws	4,0 x 40	700

Type	Count	Lenght
Windboard 18x40	4	2200

Family	Count
Romb	2

# Toronto 160 28 (488x305)

## List of all items 1

### Impregnated foundation beams

Mark	Type	Profile	Count	Length
------	------	---------	-------	--------

IFB	IFB 40x70		7	4866
-----	--------------	---	---	------

### Floor Schedule

Mark	Type	Profile	Count	Length
------	------	---------	-------	--------

FB	FB 17x114		44	2986
----	-----------	---	----	------

BB1	BB 20x40		2	4900
-----	-------------	---	---	------

BB2	BB 20x40		2	3100
-----	-------------	--	---	------

### Roof

Mark	Type	Profile	Count	Length
------	------	---------	-------	--------

RFR	Ridge 40x143		1	3748
-----	-----------------	---	---	------

RFB	Beam 40x143		4	3748
-----	----------------	---	---	------

RB	17x114		68	2846
----	--------	---	----	------

### Fascia Schedule

Mark	Type	Profile	Count	Length
------	------	---------	-------	--------

EE	Eave Edging 18x40		4	2896
----	----------------------	---	---	------

RF	Roof Fascia 18x120		4	2896
----	-----------------------	---	---	------

RR1	Roof reinforcement 18x95		2	3748
-----	--------------------------------	---	---	------

RR2	Roof reinforcement 38x38		2	3748
-----	--------------------------------	---	---	------

# Toronto 160 28 (488x305)

## List of all items 2

Wall 1			
Mark	Profile	Count	Cut Length

1BL 1	28x57	2	1818
1LG 1	28x114	18	290
1LG 2	28x114	18	758
1LG 3 *	28x114	1	1743
1LG 4 *	28x114	1	2622
1LG 5	28x114	14	1818
1LG 6 *	28x114	1	3501
1LG 7 *	28x114	1	4380
1LG 8 *	28x114	1	5076
1LG 9 *	28x114	1	864

Wall 2			
Mark	Profile	Count	Cut Length

2BL 1	28x57	1	5076
2LG 1 *	28x114	1	1743
2LG 2 *	28x114	1	2622
2LG 3 *	28x114	1	3501
2LG 4 *	28x114	1	4380
2LG 5 *	28x114	1	5076
2LG 6	28x114	16	5076
2LG 7 *	28x114	1	864

\*Gable-delivered premounted



Wall A			
Mark	Profile	Count	Cut Length

ALG 1	28x114	15	3248
ALG 2	28x114	1	3448
ATL 1	28x114	1	3748

Wall B			
Mark	Profile	Count	Cut Length

BLG 1	28x114	15	3248
BLG 2	28x114	1	3448
BTL-1	28x114	1	3748

Log Profiles	
Profile	Profile

28x57	
28x114	

Log Profiles	
Profile	Profile

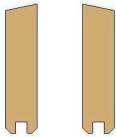
28x114	
--------	---