

Victoria B 1 9/16" (110 1/4"x110 1/4")

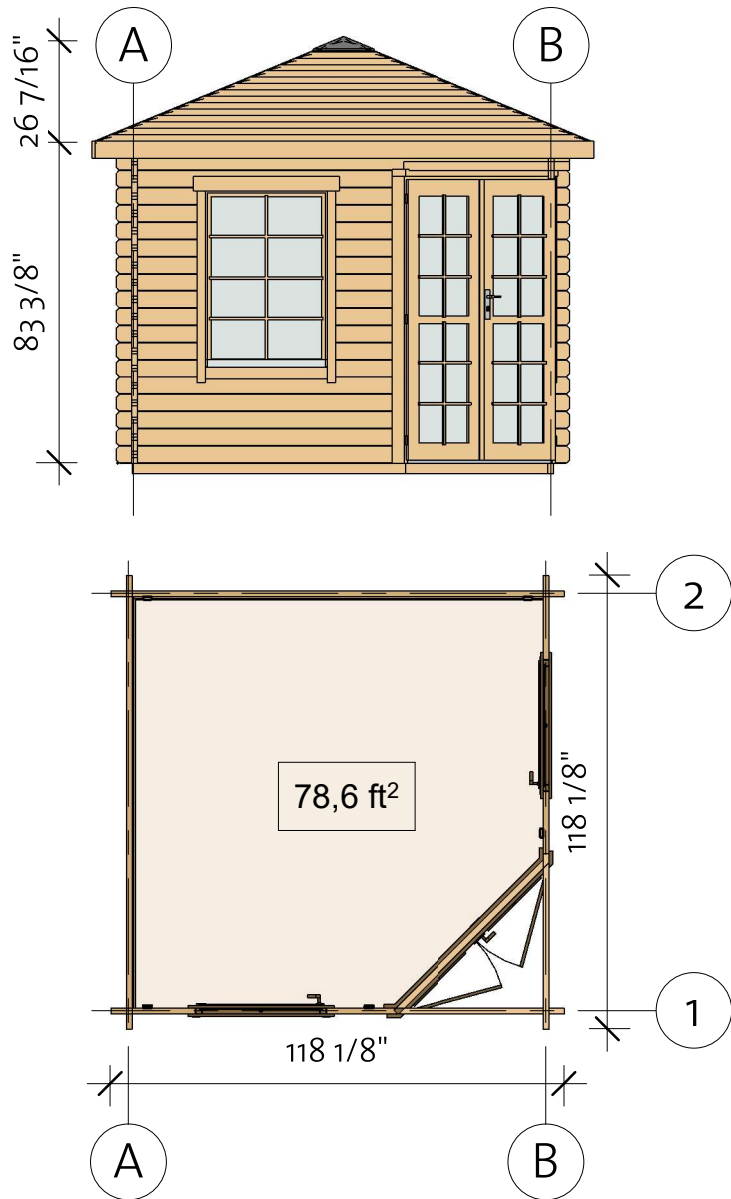

Victoria B 1 9/16" (110 1/4"x110 1/4")

Foundation

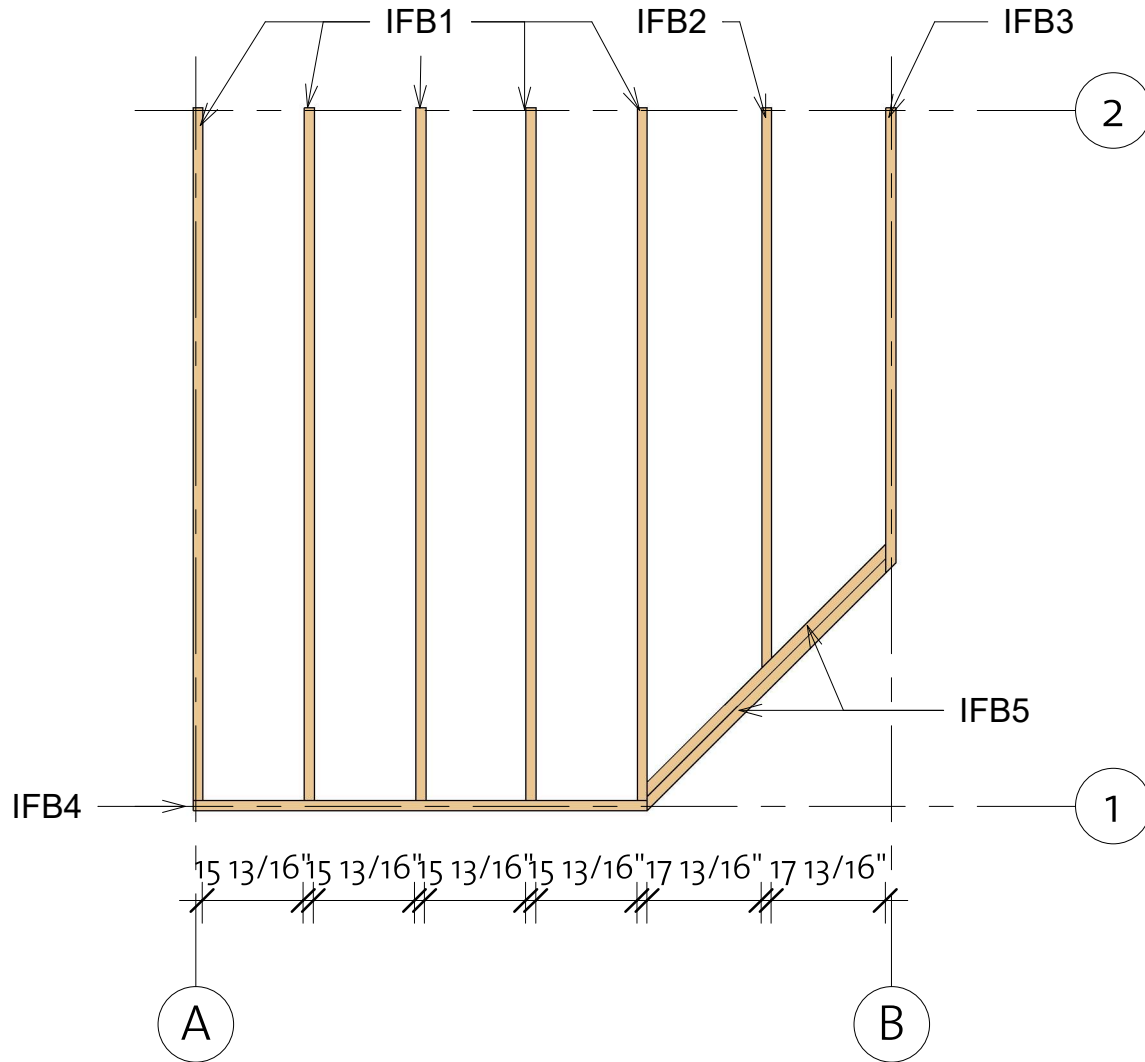

Impregnated foundation beams				
Mark	Type	Profile	Count	Length

IFB1	IFB 40x70		5	108 1/4"
IFB2	IFB 40x70		1	87 9/16"
IFB3	IFB 40x70		1	72 5/8"
IFB4	IFB 40x70		1	71 1/16"
IFB5	IFB 40x70		2	54 3/16"

Victoria B 1 9/16" (110 1/4"x110 1/4")

Floor Plan

① Baseboard

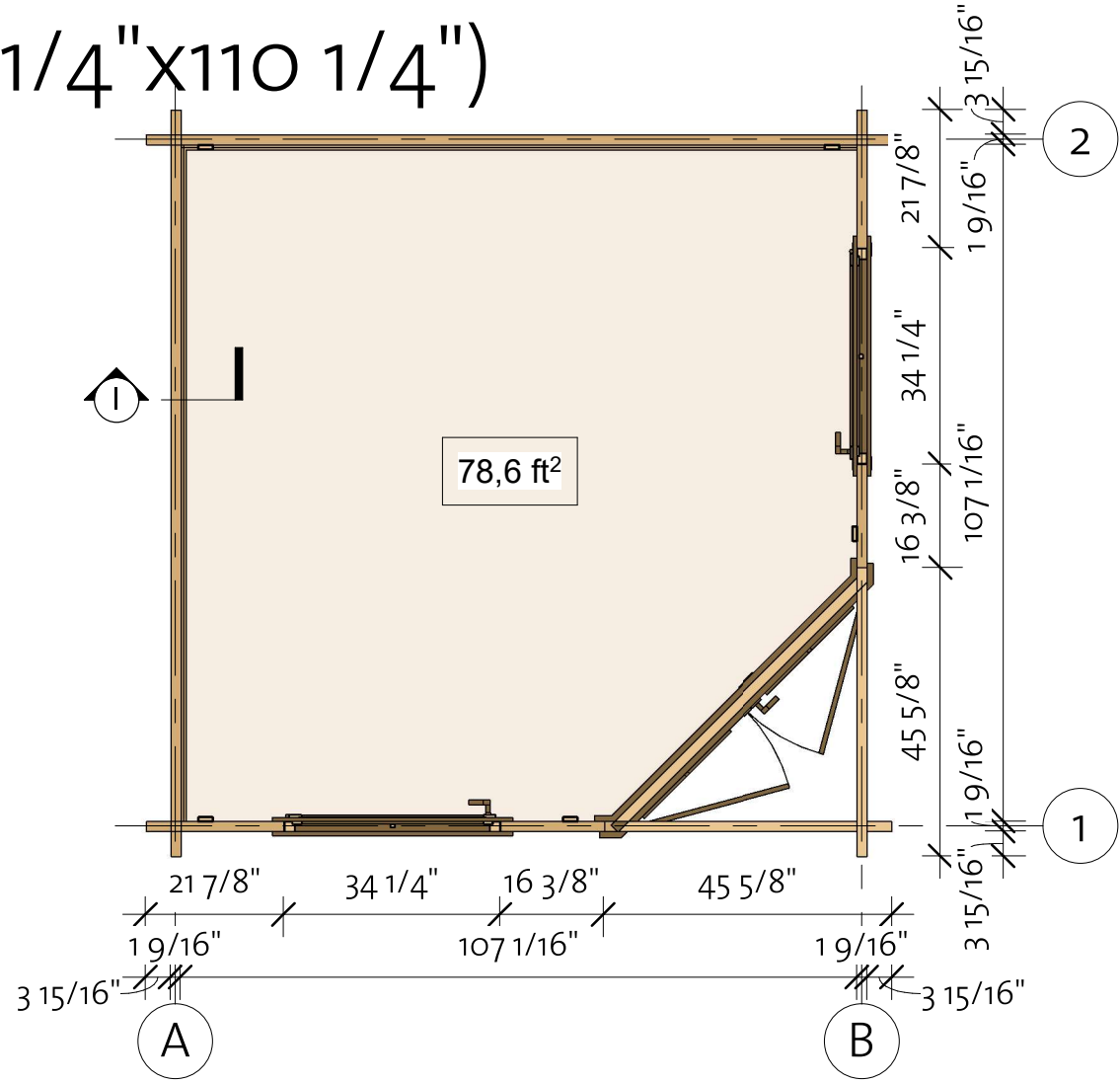
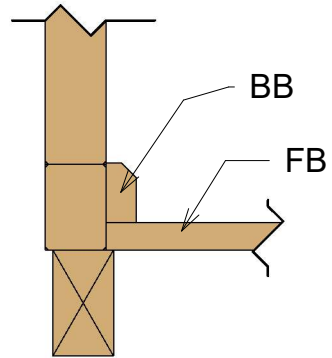

Floor Schedule

Mark	Type	Profile	Count	Length
------	------	---------	-------	--------

FB 1	FB 18x110		1	72 9/16"
FB 2	FB 18x110		1	76 7/8"
FB 3	FB 18x110		1	81 1/4"
FB 4	FB 18x110		1	85 9/16"
FB 5	FB 18x110		1	89 7/8"
FB 6	FB 18x110		1	94 3/16"
FB 7	FB 18x110		1	98 9/16"
FB 8	FB 18x110		1	102 7/8"
FB 9	FB 18x110		17	106 15/16"

BB	BB 20x40		4	110 1/4"
----	----------	---------------------------------------------------------------------------------------	---	----------

Victoria B 1 9/16" (110 1/4"x110 1/4")

Wall 1

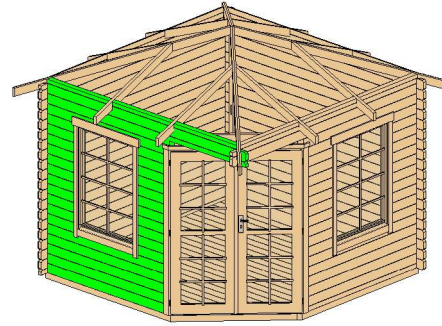

Wall 1			
Mark	Profile	Count	Cut Length

1LG 1	40x114	10	16 3/8"
1LG 2	40x114	10	21 7/8"
1LG 3	40x114	1	118 1/8"
1LG 4	40x114	1	118 1/8"
1LG 5	40x114	5	72 1/2"
1LG 6	40x114	1	72 1/2"
1LG 7	40x114	1	72 1/2"
1TL 1	40x63	1	33 11/16"
1TL 2	40x63	1	35 5/8"
1TL 3	40x63	1	35 5/8"

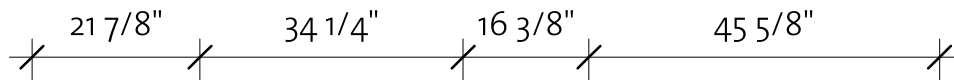
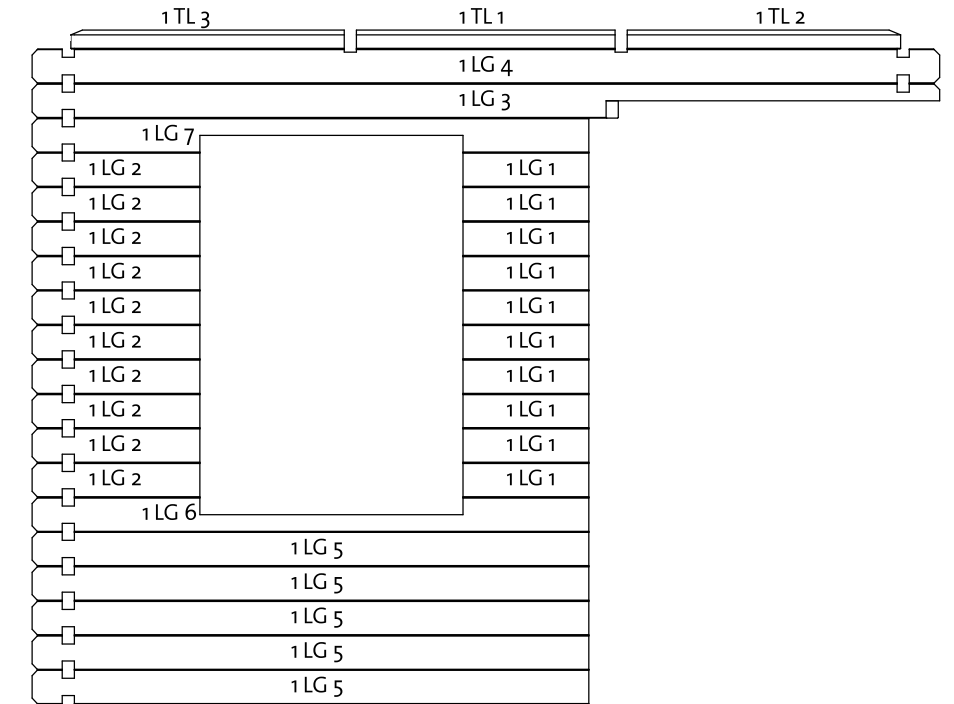

Log Profile Wall 1	
Profile	Profile



Log Profile Wall 1	
Profile	Profile



Victoria B 1 9/16" (110 1/4"x110 1/4")

Wall 2

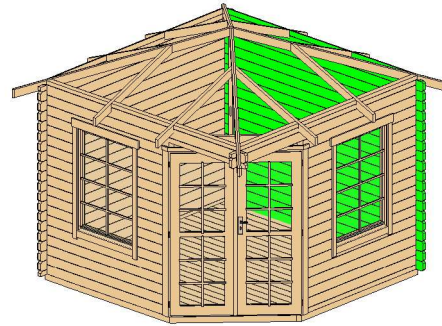

Wall 2			
Mark	Profile	Count	Cut Length

2LG 1	40x114	18	118 1/8"
2LG 2	40x114	1	118 1/8"
2TL 1	40x63	1	33 11/16"
2TL 2	40x63	1	35 5/8"
2TL 3	40x63	1	35 5/8"

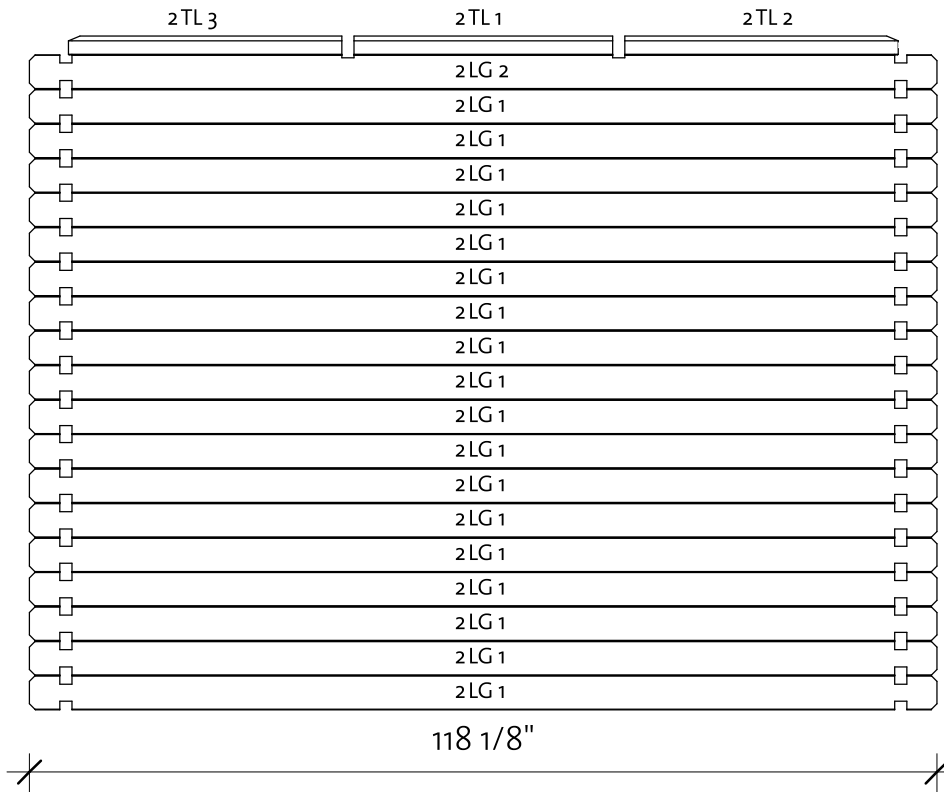

Log Profile Wall 2	
Profile	Profile

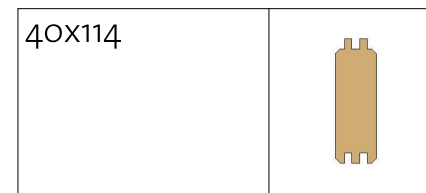

Log Profile Wall 2	
Profile	Profile

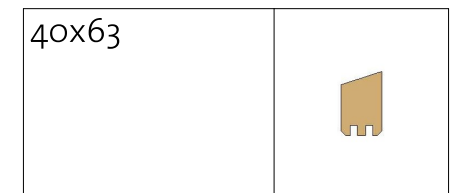

Victoria B 1 9/16" (110 1/4"x110 1/4")

Wall A

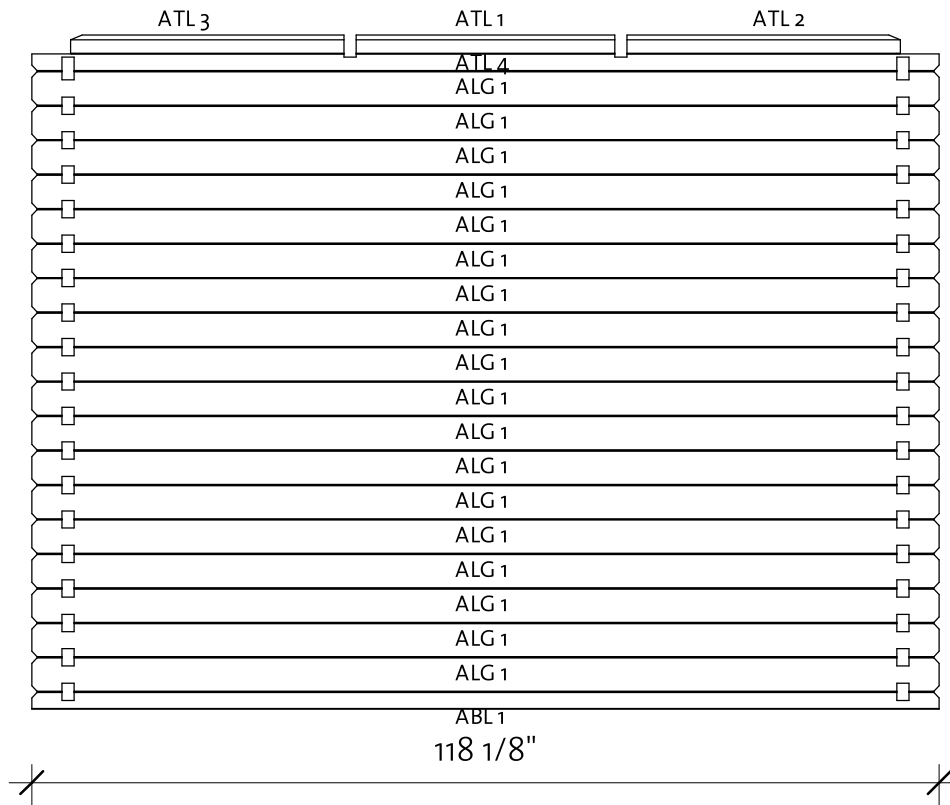
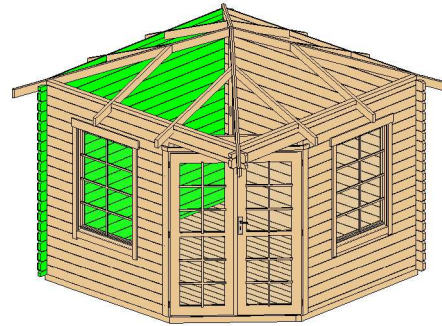

Wall A			
Mark	Profile	Count	Cut Length

ATL 1	40x63	1	33 11/16"
ATL 2	40x63	1	35 5/8"
ATL 3	40x63	1	35 5/8"
ABL 1	40x57	1	118 1/8"
ALG 1	40x114	18	118 1/8"
ATL 4	40x57 TL	1	118 1/8"

Log Profile Wall A	
Profile	Profile

40x57	
40x57 TL	
40x114	

Victoria B 1 9/16" (110 1/4"x110 1/4")

Wall B

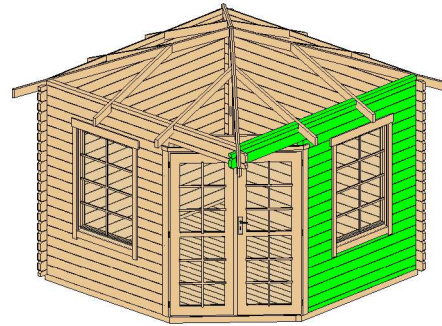

Wall B			
Mark	Profile	Count	Cut Length

BTL 1	40x63	1	33 11/16"
BTL 2	40x63	1	35 5/8"
BTL 3	40x63	1	35 5/8"
BBL 1	40x57	1	72 1/2"
BLG 1	40x114	11	16 3/8"
BLG 2	40x114	11	21 7/8"
BLG 3	40x114	5	72 1/2"
BLG 4	40x114	1	76 5/16"
BLG 5	40x114	1	118 1/8"
BTL 4	40x57 TL	1	118 1/8"

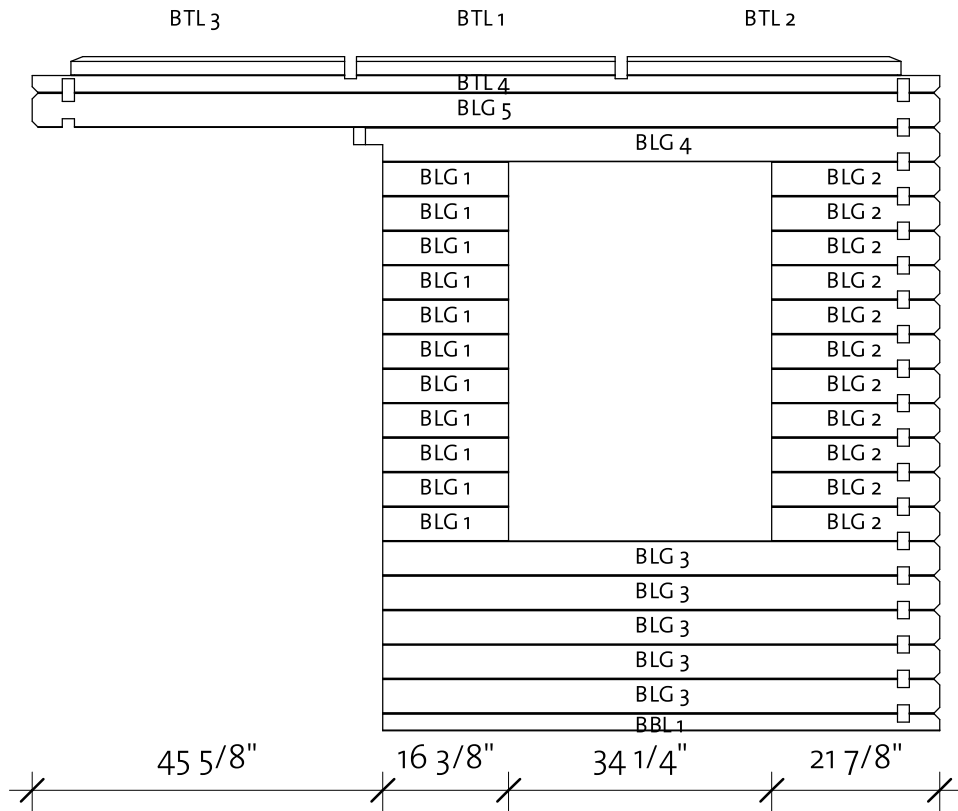

Log Profile Wall B	
Profile	Profile

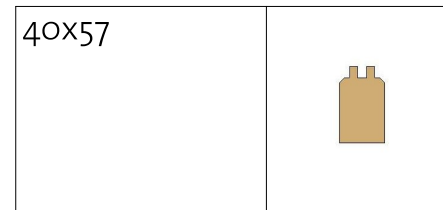

Log Profile Wall B	
Profile	Profile

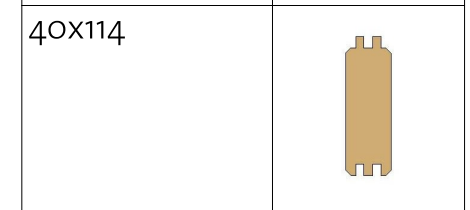
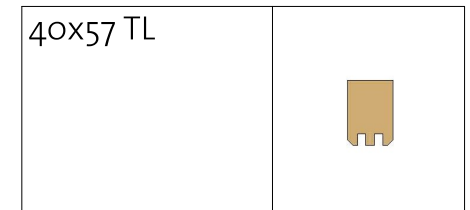

Victoria B 1 9/16" (110 1/4"x110 1/4")

Roof 1

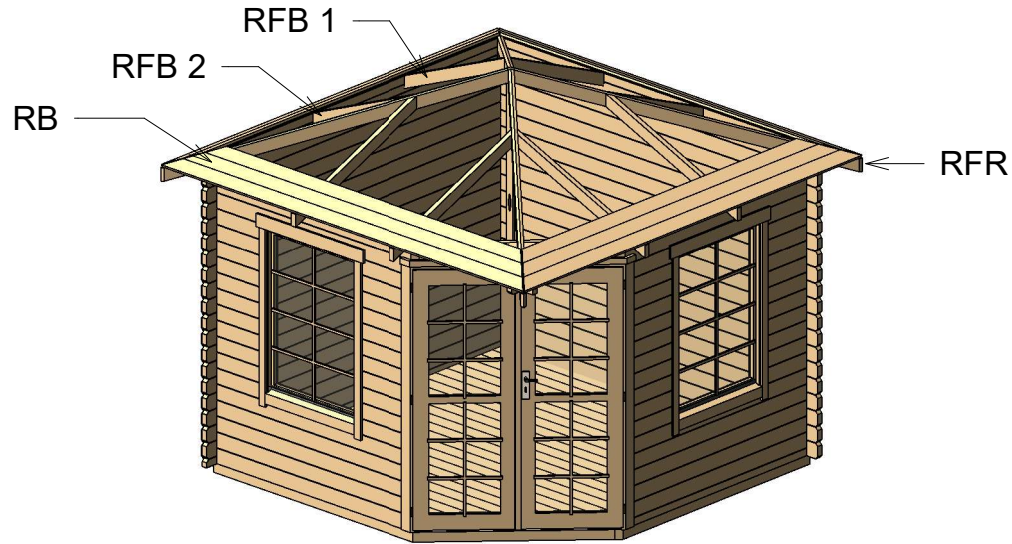

Roof				
Mark	Type	Profile	Count	Length

RFR	40x94		4	95 1/2"
RFB1 left	40x85		4	51 15/16"
RFB2 right	40x85		4	51 15/16"

Roofboards				
Mark	Type	Profile	Count	Length

RB1	RoofBoard 18x110		4	8 11/16"
RB2	RoofBoard 18x110		4	16 11/16"
RB3	RoofBoard 18x110		4	24 11/16"
RB4	RoofBoard 18x110		4	32 11/16"
RB5	RoofBoard 18x110		4	40 11/16"
RB6	RoofBoard 18x110		4	48 11/16"
RB7	RoofBoard 18x110		4	56 11/16"

Roofboards				
Mark	Type	Profile	Count	Length

RB8	RoofBoard 18x110		4	64 11/16"
RB9	RoofBoard 18x110		4	72 11/16"
RB10	RoofBoard 18x110		4	80 11/16"
RB11	RoofBoard 18x110		4	88 11/16"
RB12	RoofBoard 18x110		4	96 11/16"
RB13	RoofBoard 18x110		4	104 11/16"
RB14	RoofBoard 18x110		4	112 11/16"
RB15	RoofBoard 18x110		4	120 11/16"
RB16	RoofBoard 18x110		4	128 11/16"

Victoria B 1 9/16" (110 1/4"x110 1/4")

Roof 2

Fascia Schedule				
Mark	Type	Profile	Count	Length

RF	Roof Fascia 18x115		4	130"
----	-----------------------	-------------------------------------------------------------------------------------	---	------

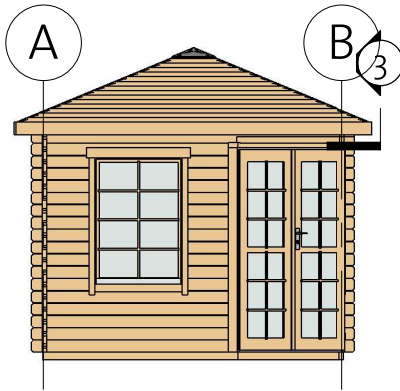

③ Fascia

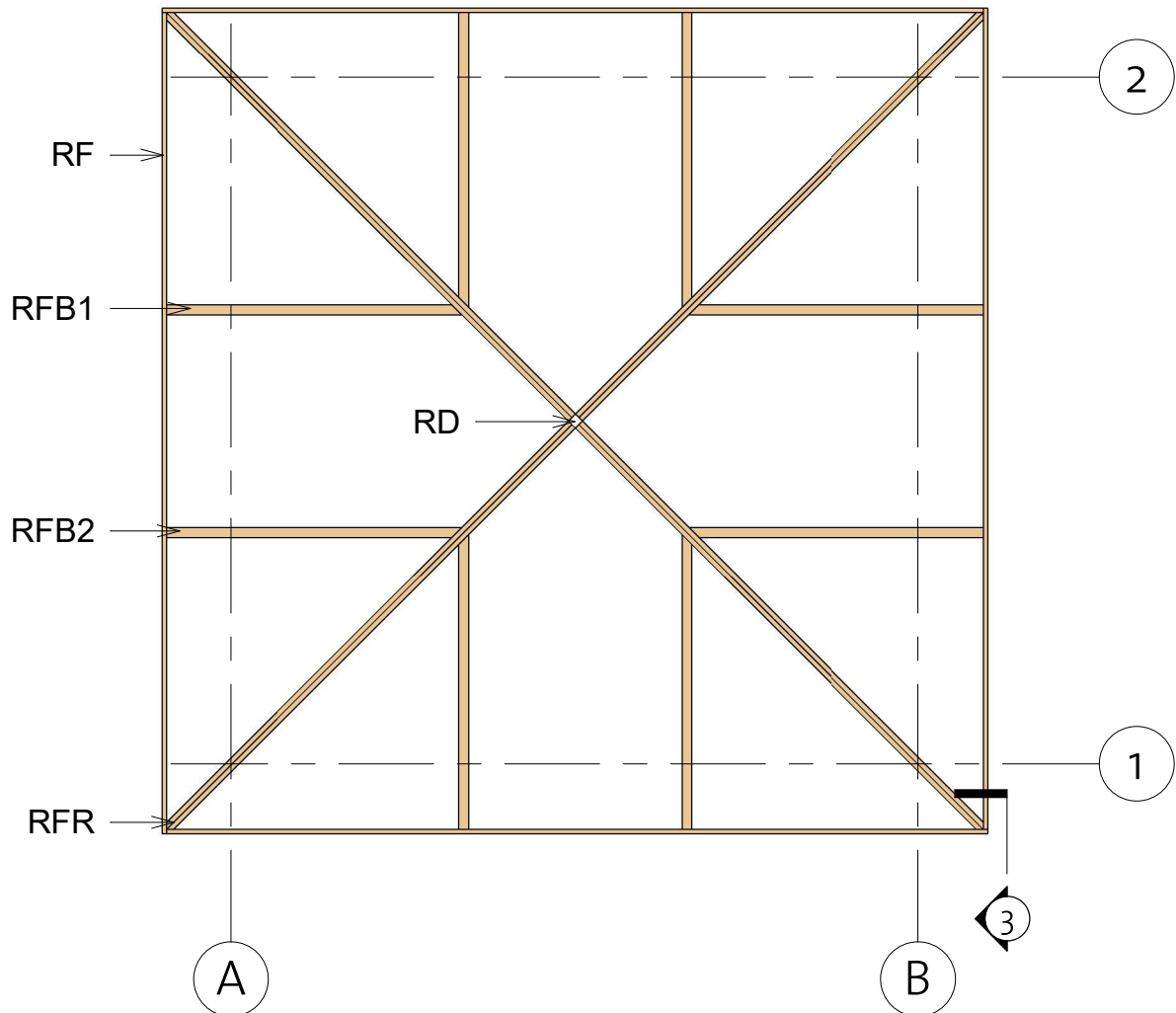
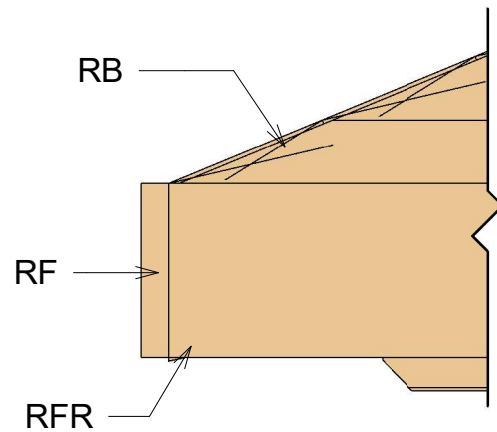

Victoria B 1 9/16" (110 1/4"x110 1/4")

Extras

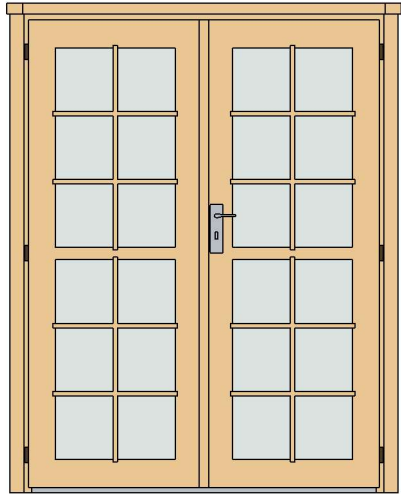

Door Schedule				
Model	Type	Width	Height	Count
CDD4R	Classic double door 4, two glass right	56 1/8"	74 13/16"	1
DCB6	Door crossbar 6	--	--	4

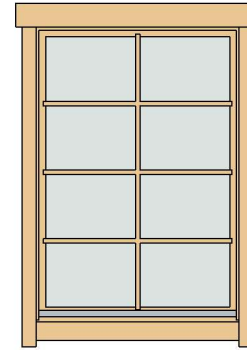

Window Schedule				
Model	Type	Width	Height	Count
CW2L	Classic window 2 left	34 1/16"	47 5/8"	1
CW2R	Classic window 2 right	34 1/16"	47 5/8"	1
WCB8	Window crossbar 8	--	--	2

Fasteners & Extras		
Name	Type	Count
Bolts	M5/16" x 2 3/4"	15
Hitblock	11 13/16"-15 3/4"	
Nails	1/16" x 1 9/16"	30
Screws	3/16" x 1 9/16"	130
Screws	3/16" x 2"	470
Screws	3/16" x 2 3/4"	50
Screws	1/4" x 5 1/2"	50



Type	Count	Lenght
Windboard 18x40	5	86 5/8"
Roof Detdail		
Mark	Type	Count
RD	Roof detail	1

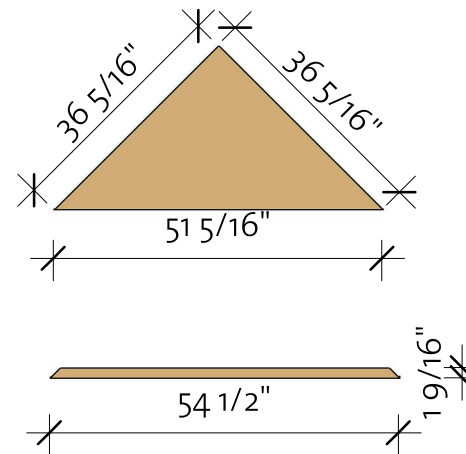

① Roof top

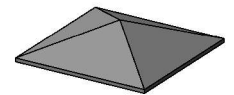

Type	Mark	Count
Ceiling detail 40x120	CD	1
Ceiling triangle	CT	1

Victoria B 1 9/16" (110 1/4"x110 1/4")

List of all items 1

Impregnated foundation beams

Mark	Type	Profile	Count	Length
------	------	---------	-------	--------

IFB1	IFB 40x70		5	108 1/4"
IFB2	IFB 40x70		1	87 9/16"
IFB3	IFB 40x70		1	72 5/8"
IFB4	IFB 40x70		1	71 1/16"
IFB5	IFB 40x70		2	54 3/16"

Floor Schedule

Mark	Type	Profile	Count	Length
------	------	---------	-------	--------

FB 1	FB 18x110		1	72 9/16"
FB 2	FB 18x110		1	76 7/8"
FB 3	FB 18x110		1	81 1/4"
FB 4	FB 18x110		1	85 9/16"
FB 5	FB 18x110		1	89 7/8"
FB 6	FB 18x110		1	94 3/16"
FB 7	FB 18x110		1	98 9/16"
FB 8	FB 18x110		1	102 7/8"
FB 9	FB 18x110		17	106 15/16"

BB	BB 20x40		4	110 1/4"
----	-------------	---------------------------------------------------------------------------------------	---	----------

Victoria B 1 9/16" (110 1/4"x110 1/4")

List of all items 2

Wall 1			
Mark	Profile	Count	Cut Length

1LG 1	40x114	10	16 3/8"
1LG 2	40x114	10	21 7/8"
1LG 3	40x114	1	118 1/8"
1LG 4	40x114	1	118 1/8"
1LG 5	40x114	5	72 1/2"
1LG 6	40x114	1	72 1/2"
1LG 7	40x114	1	72 1/2"
1TL 1	40x63	1	33 11/16"
1TL 2	40x63	1	35 5/8"
1TL 3	40x63	1	35 5/8"

Wall A			
Mark	Profile	Count	Cut Length

ATL 1	40x63	1	33 11/16"
ATL 2	40x63	1	35 5/8"
ATL 3	40x63	1	35 5/8"
ABL 1	40x57	1	118 1/8"
ALG 1	40x114	18	118 1/8"
ATL 4	40x57 TL	1	118 1/8"



Wall 2			
Mark	Profile	Count	Cut Length

2LG 1	40x114	18	118 1/8"
2LG 2	40x114	1	118 1/8"
2TL 1	40x63	1	33 11/16"
2TL 2	40x63	1	35 5/8"
2TL 3	40x63	1	35 5/8"



Wall B			
Mark	Profile	Count	Cut Length

BTL 1	40x63	1	33 11/16"
BTL 2	40x63	1	35 5/8"
BTL 3	40x63	1	35 5/8"
BBL 1	40x57	1	72 1/2"
BLG 1	40x114	11	16 3/8"
BLG 2	40x114	11	21 7/8"
BLG 3	40x114	5	72 1/2"
BLG 4	40x114	1	76 5/16"
BLG 5	40x114	1	118 1/8"
BTL 4	40x57 TL	1	118 1/8"

Log Profiles	
Profile	Profile

40x114	
40x57	

Log Profiles	
Profile	Profile



40x63	
40x57 TL	

Log Profiles	
Profile	Profile

40x114	
--------	---------------------------------------------------------------------------------------

Victoria B 1 9/16" (110 1/4"x110 1/4")

List of all items 3

Roof					Roofboards				
Mark	Type	Profile	Count	Length	Mark	Type	Profile	Count	Length
RFR	40x94		4	95 1/2"	RB1	RoofBoard 18x110		4	8 11/16"
RFB1 left	40x85		4	51 15/16"	RB2	RoofBoard 18x110		4	16 11/16"
RFB2 right	40x85		4	51 15/16"	RB3	RoofBoard 18x110		4	24 11/16"
					RB4	RoofBoard 18x110		4	32 11/16"
					RB5	RoofBoard 18x110		4	40 11/16"
					RB6	RoofBoard 18x110		4	48 11/16"
					RB7	RoofBoard 18x110		4	56 11/16"
					RB8	RoofBoard 18x110		4	64 11/16"
					RB9	RoofBoard 18x110		4	72 11/16"
					RB10	RoofBoard 18x110		4	80 11/16"
					RB11	RoofBoard 18x110		4	88 11/16"
					RB12	RoofBoard 18x110		4	96 11/16"
					RB13	RoofBoard 18x110		4	104 11/16"
					RB14	RoofBoard 18x110		4	112 11/16"
					RB15	RoofBoard 18x110		4	120 11/16"
					RB16	RoofBoard 18x110		4	128 11/16"

Fascia Schedule				
Mark	Type	Profile	Count	Length
RF	Roof Fascia 18x115		4	130"