

# Victoria B 40 (280x280)

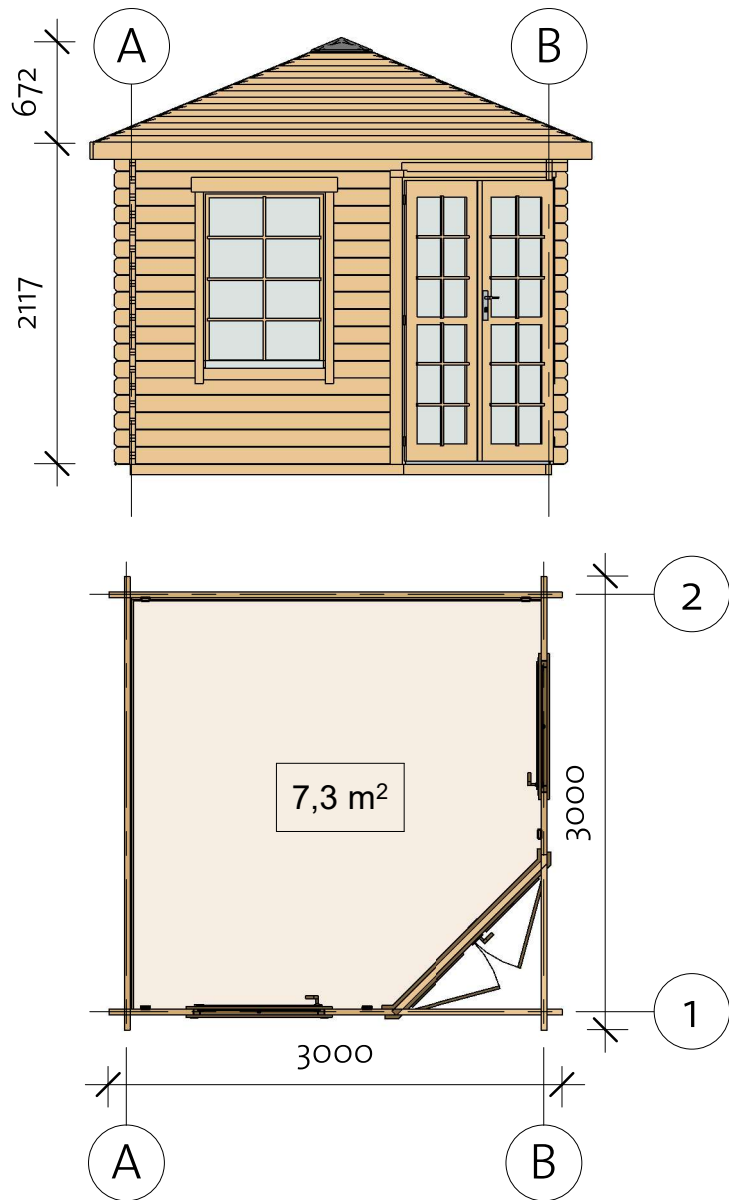

# Victoria B 40 (280x280)

Foundation

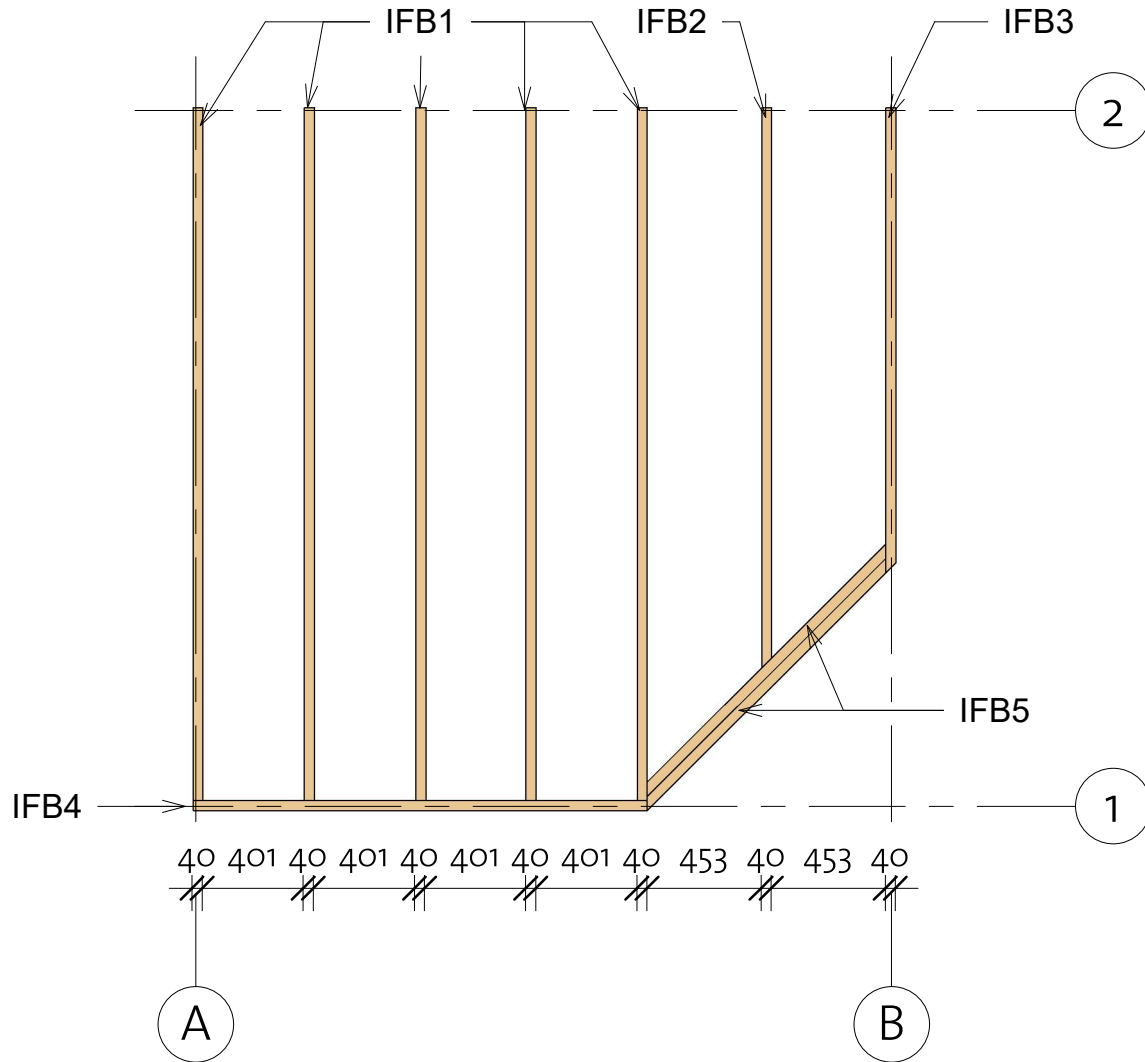

Impregnated foundation beams				
Mark	Type	Profile	Count	Length
IFB1	IFB 40x70		5	2750
IFB2	IFB 40x70		1	2224
IFB3	IFB 40x70		1	1845
IFB4	IFB 40x70		1	1805
IFB5	IFB 40x70		2	1376

# Victoria B 40 (280x280)

Floor Plan

① Baseboard

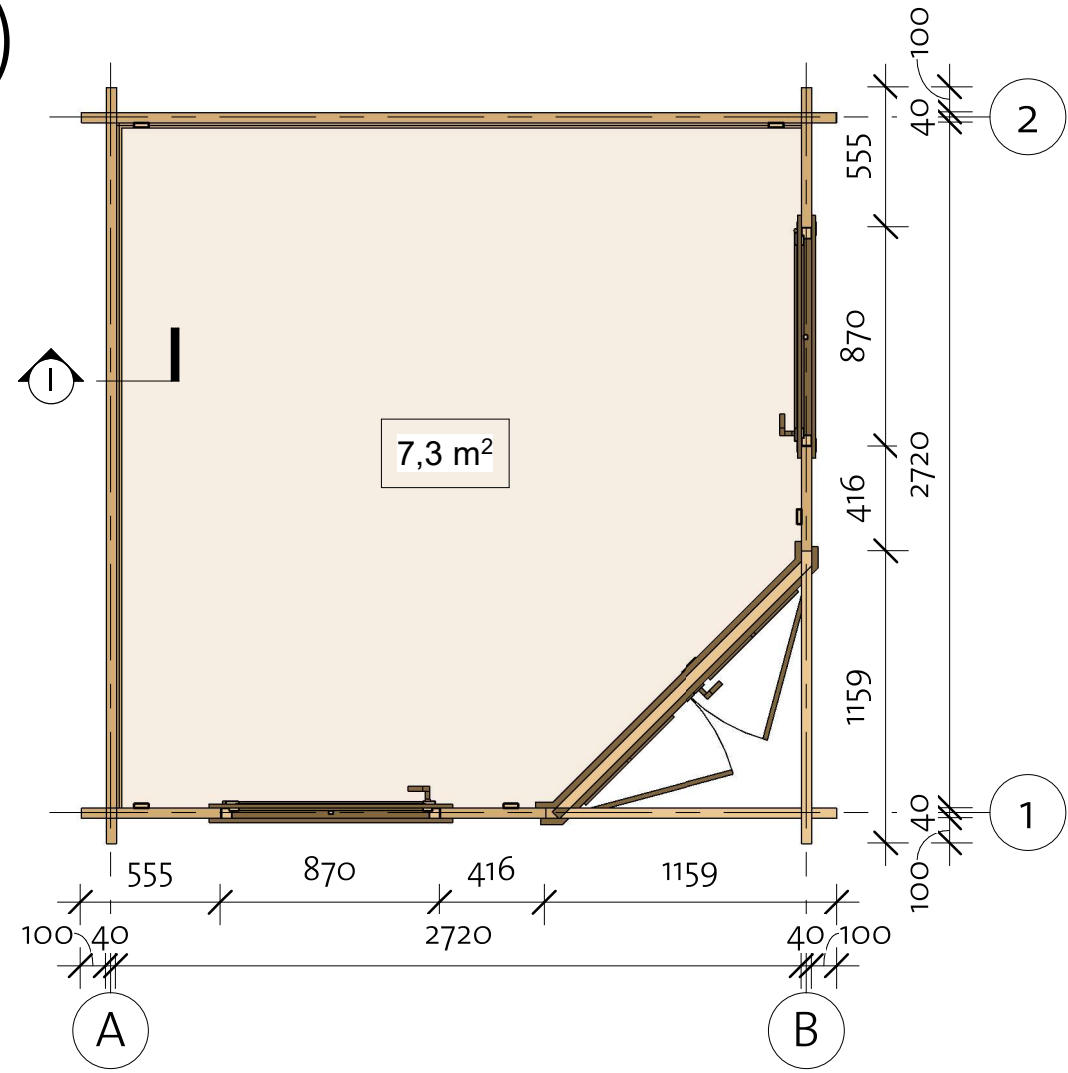
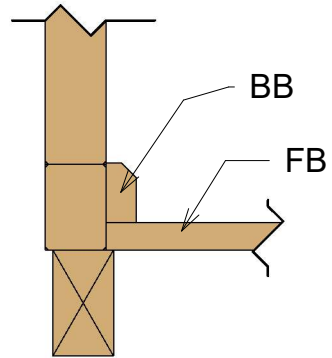

Floor Schedule				
Mark	Type	Profile	Count	Length

FB 1	FB 18x110		1	1843
FB 2	FB 18x110		1	1953
FB 3	FB 18x110		1	2063
FB 4	FB 18x110		1	2173
FB 5	FB 18x110		1	2283
FB 6	FB 18x110		1	2393
FB 7	FB 18x110		1	2503
FB 8	FB 18x110		1	2613
FB 9	FB 18x110		17	2717

BB	BB 20x40		4	2800
----	----------	---	---	------

# Victoria B 40 (280x280)

Wall 1

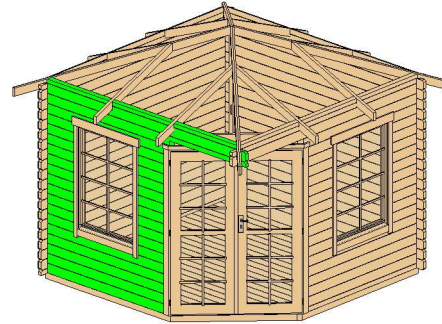

Wall 1			
Mark	Profile	Count	Cut Length

1LG 1	40x114	10	416
1LG 2	40x114	10	555
1LG 3	40x114	1	3000
1LG 4	40x114	1	3000
1LG 5	40x114	5	1841
1LG 6	40x114	1	1841
1LG 7	40x114	1	1841
1TL 1	40x63	1	855
1TL 2	40x63	1	904
1TL 3	40x63	1	904

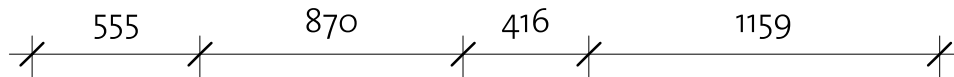
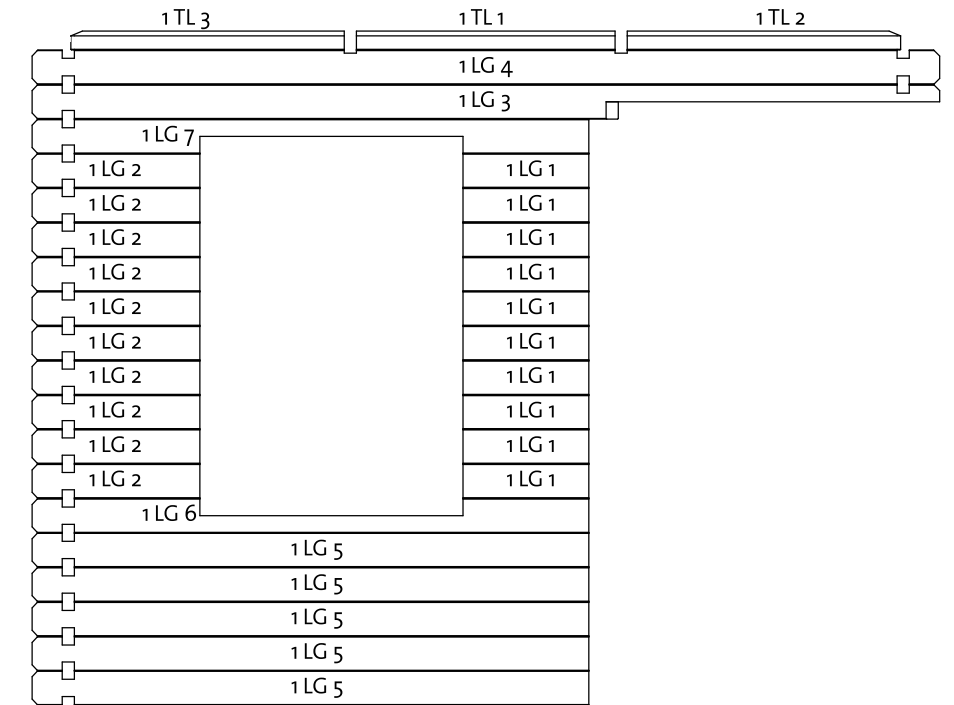

Log Profile Wall 1	
Profile	Profile

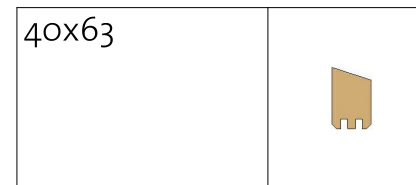

Log Profile Wall 1	
Profile	Profile

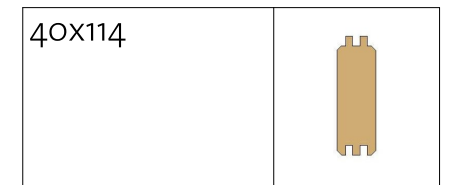

# Victoria B 40 (280x280)

Wall 2

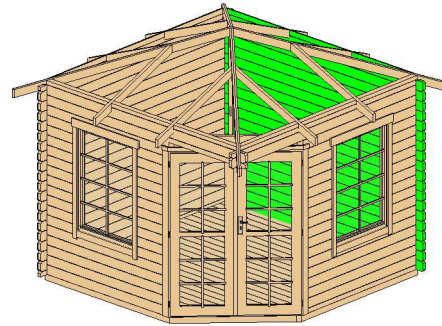

Wall 2			
Mark	Profile	Count	Cut Length

2LG 1	40x114	18	3000
2LG 2	40x114	1	3000
2TL 1	40x63	1	855
2TL 2	40x63	1	904
2TL 3	40x63	1	904

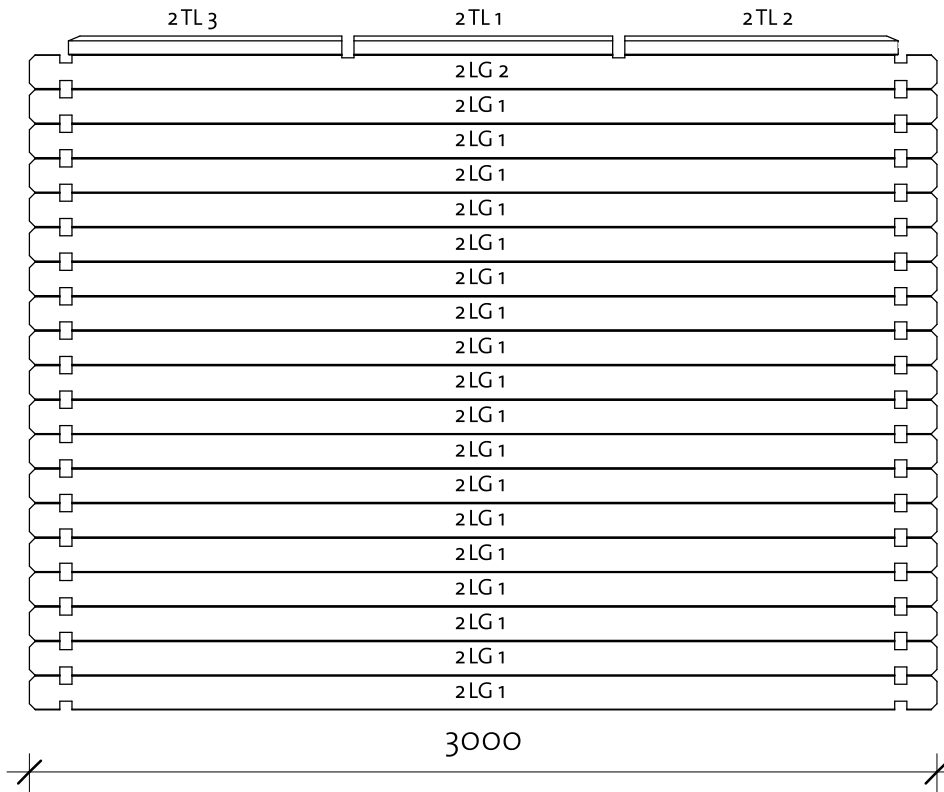

Log Profile Wall 2	
Profile	Profile

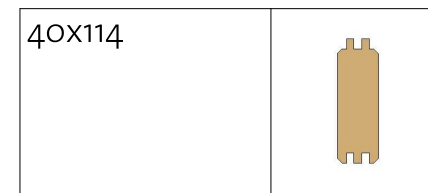

Log Profile Wall 2	
Profile	Profile

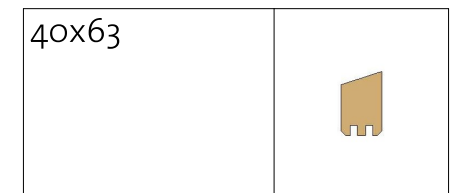

# Victoria B 40 (280x280)

Wall A

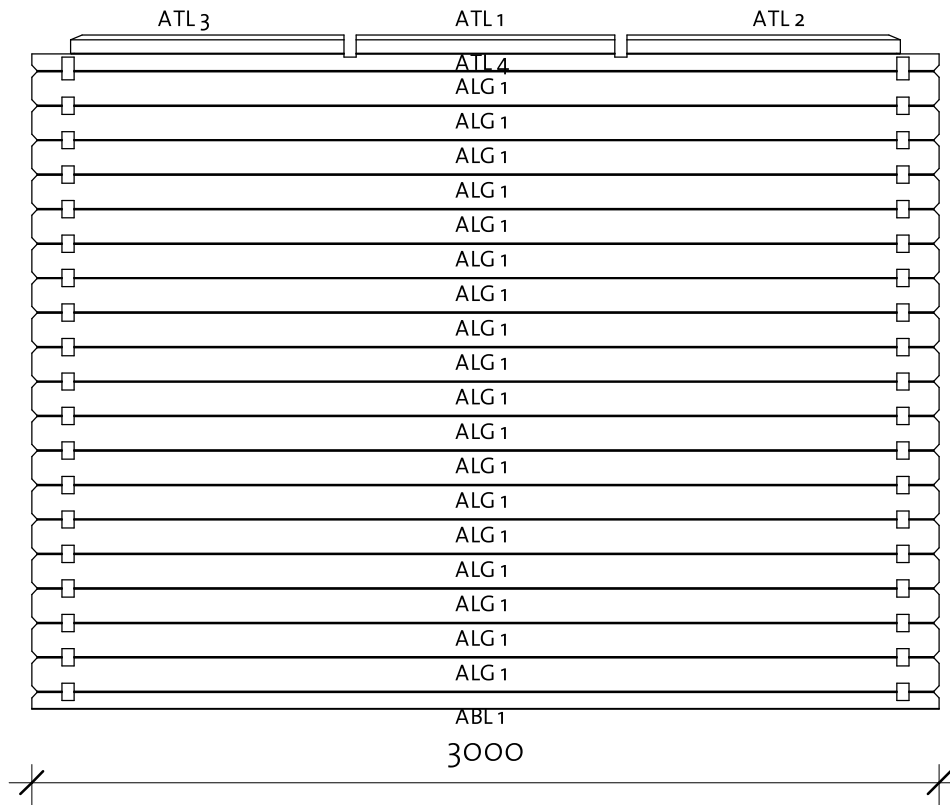
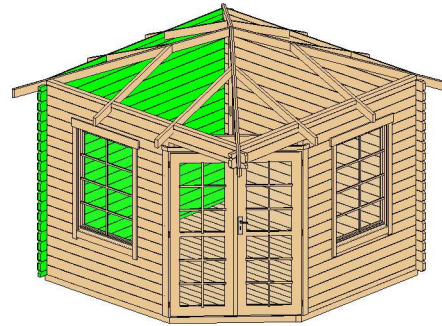

Wall A			
Mark	Profile	Count	Cut Length

ATL 1	40x63	1	855
ATL 2	40x63	1	904
ATL 3	40x63	1	904
ABL 1	40x57	1	3000
ALG 1	40x114	18	3000
ATL 4	40x57 TL	1	3000

Log Profile Wall A	
Profile	Profile

40x57	
40x57 TL	
40x114	

# Victoria B 40 (280x280)

Wall B

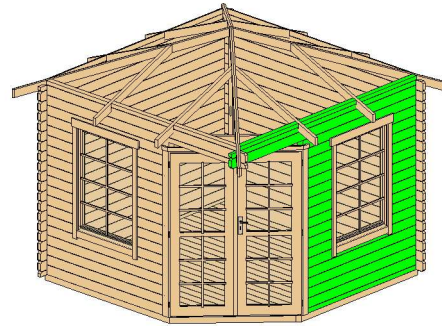

Wall B			
Mark	Profile	Count	Cut Length

BTL 1	40x63	1	855
BTL 2	40x63	1	904
BTL 3	40x63	1	904
BBL 1	40x57	1	1841
BLG 1	40x114	11	416
BLG 2	40x114	11	555
BLG 3	40x114	5	1841
BLG 4	40x114	1	1938
BLG 5	40x114	1	3000
BTL 4	40x57 TL	1	3000

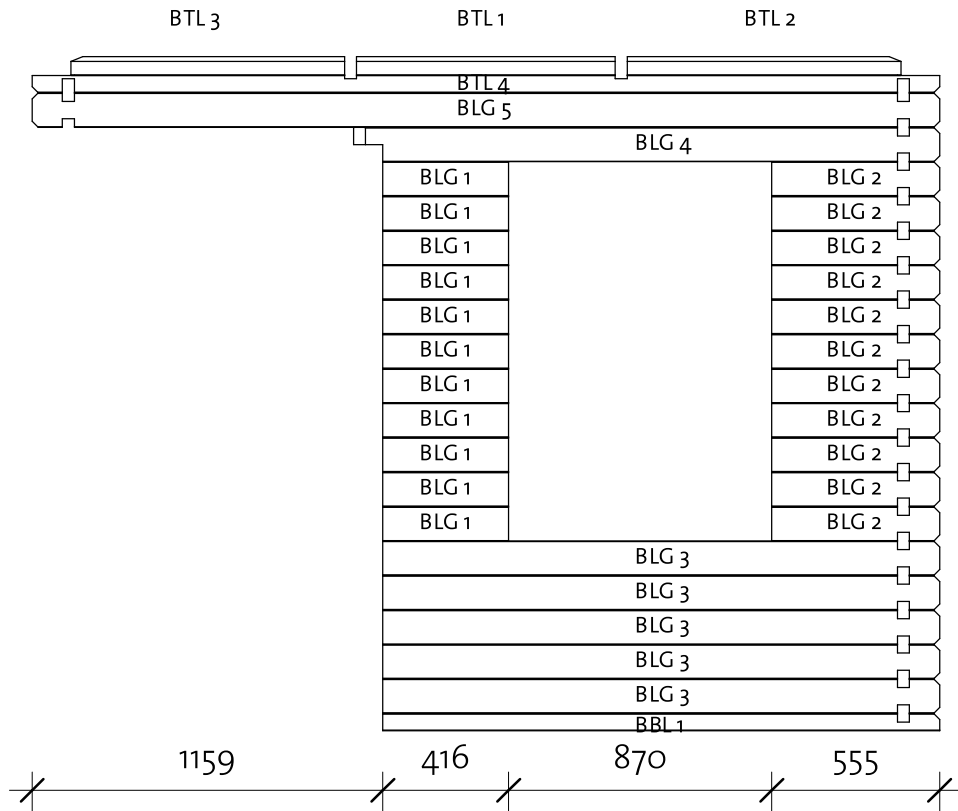

Log Profile Wall B	
Profile	Profile

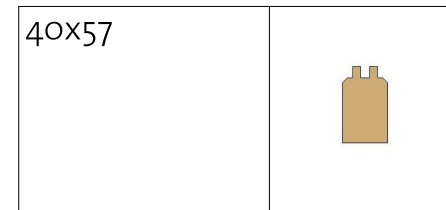

Log Profile Wall B	
Profile	Profile

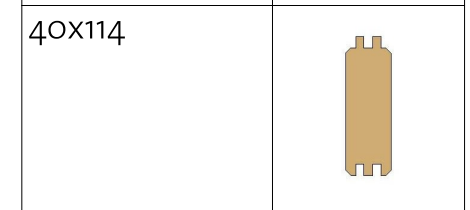
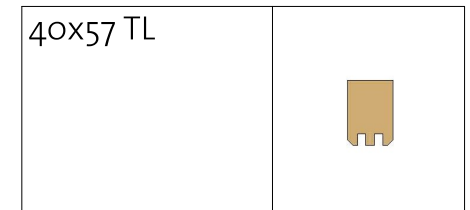

# Victoria B 40 (280x280)

Roof 1

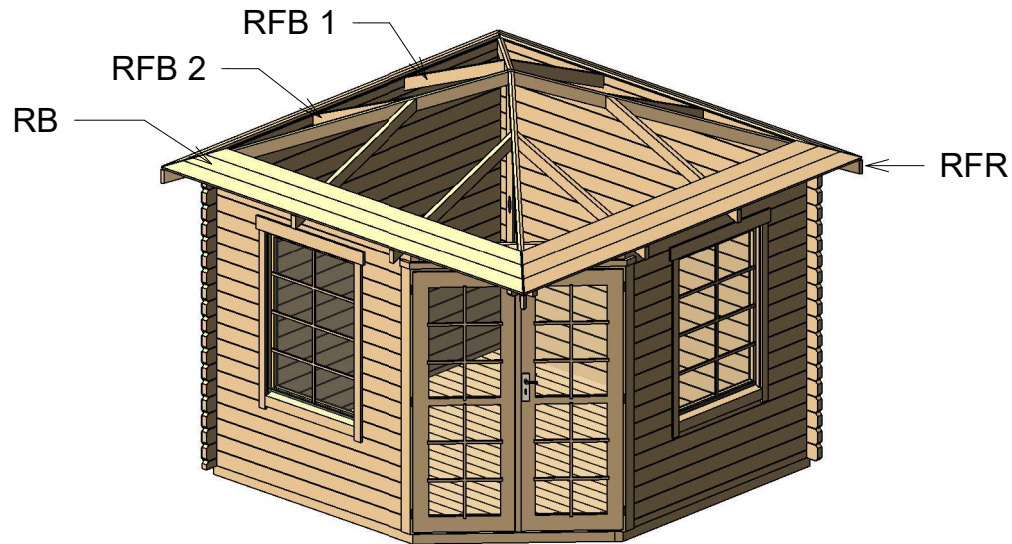

Roof				
Mark	Type	Profile	Count	Length

RFR	40x94		4	2426
RFB1 left	40x85		4	1319
RFB2 right	40x85		4	1319

Roofboards				
Mark	Type	Profile	Count	Length

RB1	RoofBoard 18x110		4	221
RB2	RoofBoard 18x110		4	424
RB3	RoofBoard 18x110		4	627
RB4	RoofBoard 18x110		4	830
RB5	RoofBoard 18x110		4	1034
RB6	RoofBoard 18x110		4	1237
RB7	RoofBoard 18x110		4	1440

Roofboards				
Mark	Type	Profile	Count	Length

RB8	RoofBoard 18x110		4	1643
RB9	RoofBoard 18x110		4	1847
RB10	RoofBoard 18x110		4	2050
RB11	RoofBoard 18x110		4	2253
RB12	RoofBoard 18x110		4	2456
RB13	RoofBoard 18x110		4	2660
RB14	RoofBoard 18x110		4	2863
RB15	RoofBoard 18x110		4	3066
RB16	RoofBoard 18x110		4	3269



# Victoria B 40 (280x280)

Roof 2

Fascia Schedule				
Mark	Type	Profile	Count	Length
RF	Roof Fascia 18x115		4	3302

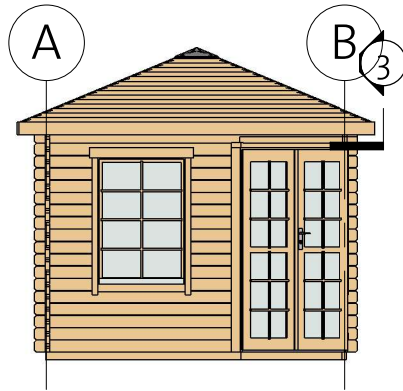

③ Fascia

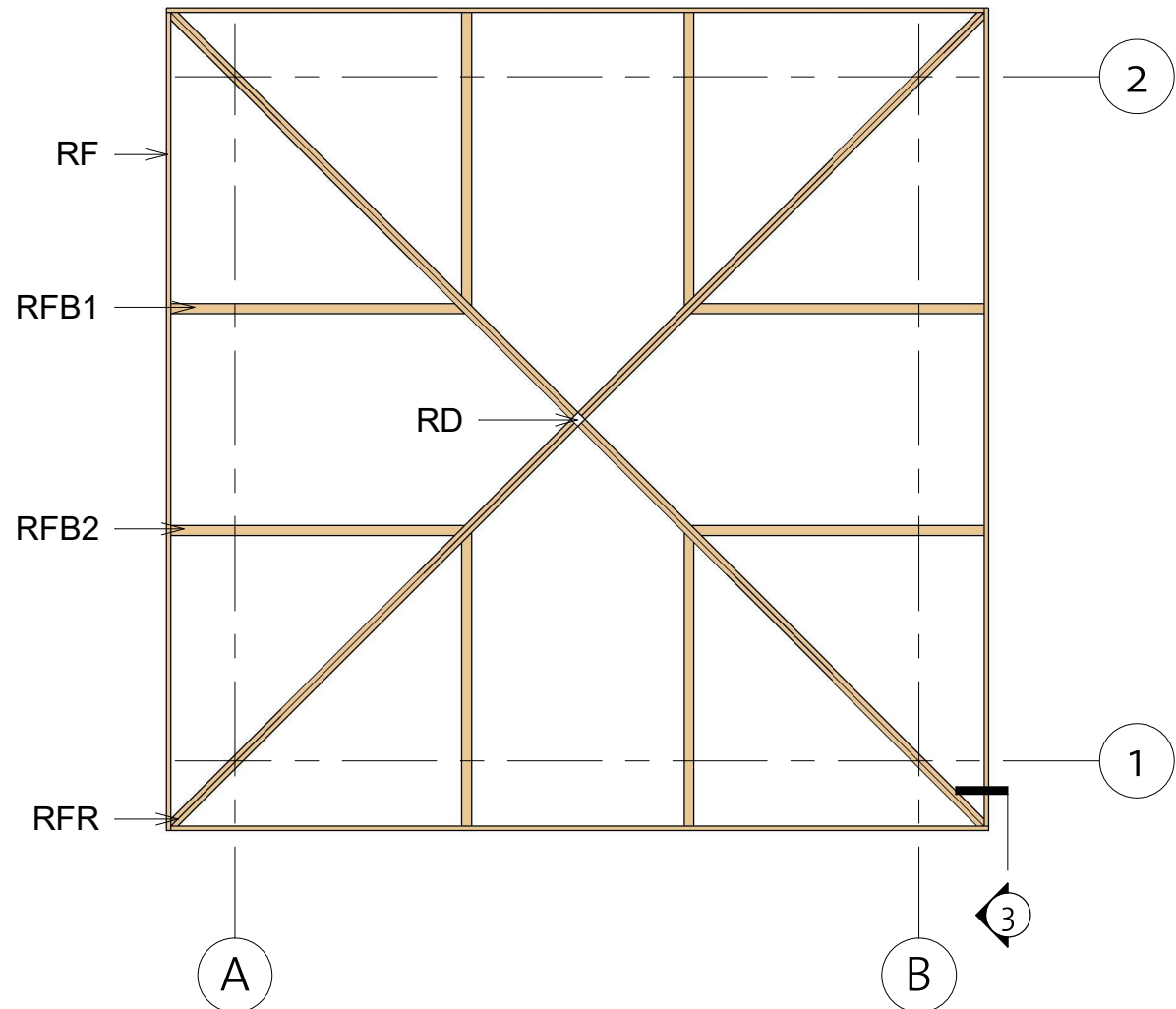
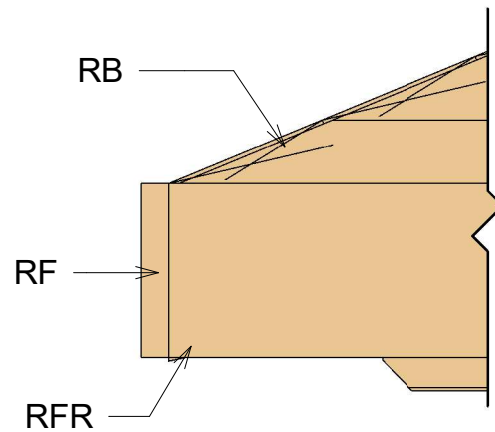

# Victoria B 40 (280x280)

Extras

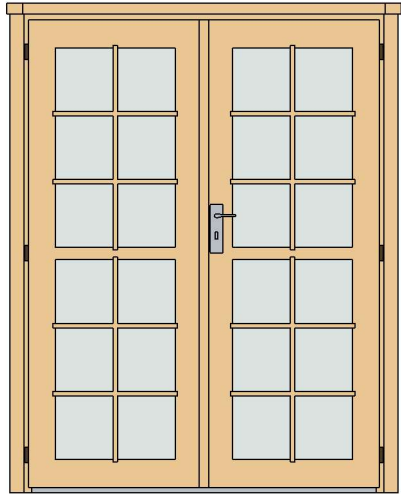

Door Schedule				
Model	Type	Width	Height	Count
CDD4R	Classic double door 4, two glass right	1425	1900	1
DCB6	Door crossbar 6	--	--	4

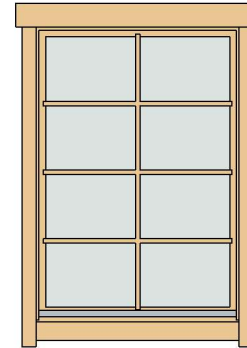

Window Schedule				
Model	Type	Width	Height	Count
CW2L	Classic window 2 left	865	1210	1
CW2R	Classic window 2 right	865	1210	1
WCB8	Window crossbar 8	--	--	2

Fasteners & Extras		
Name	Type	Count

Bolts	M8 x 70	15
Hitblock	300-400 mm	
Nails	1,4 x 40	30
Screws	4,0 x 40	130
Screws	4,0 x 50	470
Screws	5,0 x 70	50
Screws	6,0 x 140	50

190422



Type	Count	Lenght
------	-------	--------

Windboard 18x40	5	2200
-----------------	---	------

Roof Detdail		
Mark	Type	Count

RD	Roof detail	1
----	-------------	---

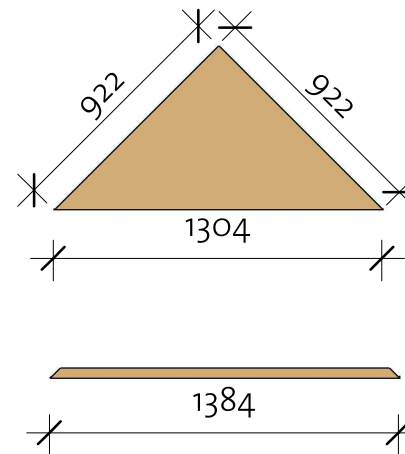

① Roof top

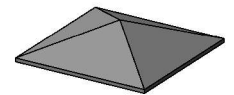

Type	Mark	Count
------	------	-------

Ceiling detail 40x120	CD	1
Ceiling triangle	CT	1

# Victoria B 40 (280x280)

## List of all items 1

### Impregnated foundation beams

Mark	Type	Profile	Count	Length
------	------	---------	-------	--------

IFB1	IFB 40x70		5	2750
IFB2	IFB 40x70		1	2224
IFB3	IFB 40x70		1	1845
IFB4	IFB 40x70		1	1805
IFB5	IFB 40x70		2	1376

### Floor Schedule

Mark	Type	Profile	Count	Length
------	------	---------	-------	--------

FB 1	FB 18x110		1	1843
FB 2	FB 18x110		1	1953
FB 3	FB 18x110		1	2063
FB 4	FB 18x110		1	2173
FB 5	FB 18x110		1	2283
FB 6	FB 18x110		1	2393
FB 7	FB 18x110		1	2503
FB 8	FB 18x110		1	2613
FB 9	FB 18x110		17	2717

BB	BB 20x40		4	2800
----	-------------	---	---	------

# Victoria B 40 (280x280)

## List of all items 2

Wall 1			
Mark	Profile	Count	Cut Length

1LG 1	40x114	10	416
1LG 2	40x114	10	555
1LG 3	40x114	1	3000
1LG 4	40x114	1	3000
1LG 5	40x114	5	1841
1LG 6	40x114	1	1841
1LG 7	40x114	1	1841
1TL 1	40x63	1	855
1TL 2	40x63	1	904
1TL 3	40x63	1	904

Wall A			
Mark	Profile	Count	Cut Length

ATL 1	40x63	1	855
ATL 2	40x63	1	904
ATL 3	40x63	1	904
ABL 1	40x57	1	3000
ALG 1	40x114	18	3000
ATL 4	40x57 TL	1	3000



Wall 2			
Mark	Profile	Count	Cut Length

2LG 1	40x114	18	3000
2LG 2	40x114	1	3000
2TL 1	40x63	1	855
2TL 2	40x63	1	904
2TL 3	40x63	1	904



Wall B			
Mark	Profile	Count	Cut Length

BTL 1	40x63	1	855
BTL 2	40x63	1	904
BTL 3	40x63	1	904
BBL 1	40x57	1	1841
BLG 1	40x114	11	416
BLG 2	40x114	11	555
BLG 3	40x114	5	1841
BLG 4	40x114	1	1938
BLG 5	40x114	1	3000
BTL 4	40x57 TL	1	3000

Log Profiles	
Profile	Profile

40x114	
40x57	

Log Profiles	
Profile	Profile

40x63	
40x57 TL	

Log Profiles	
Profile	Profile

40x114	
--------	---

# Victoria B 40 (280x280)

## List of all items 3

Roof				
Mark	Type	Profile	Count	Length
RFR	40x94		4	2426
RFB1 left	40x85		4	1319
RFB2 right	40x85		4	1319

Roofboards				
Mark	Type	Profile	Count	Length
RB1	RoofBoard 18x110		4	221
RB2	RoofBoard 18x110		4	424
RB3	RoofBoard 18x110		4	627
RB4	RoofBoard 18x110		4	830
RB5	RoofBoard 18x110		4	1034
RB6	RoofBoard 18x110		4	1237
RB7	RoofBoard 18x110		4	1440

Roofboards				
Mark	Type	Profile	Count	Length
RB8	RoofBoard 18x110		4	1643
RB9	RoofBoard 18x110		4	1847
RB10	RoofBoard 18x110		4	2050
RB11	RoofBoard 18x110		4	2253
RB12	RoofBoard 18x110		4	2456
RB13	RoofBoard 18x110		4	2660
RB14	RoofBoard 18x110		4	2863
RB15	RoofBoard 18x110		4	3066
RB16	RoofBoard 18x110		4	3269

Fascia Schedule				
Mark	Type	Profile	Count	Length
RF	Roof Fascia 18x115		4	3302