

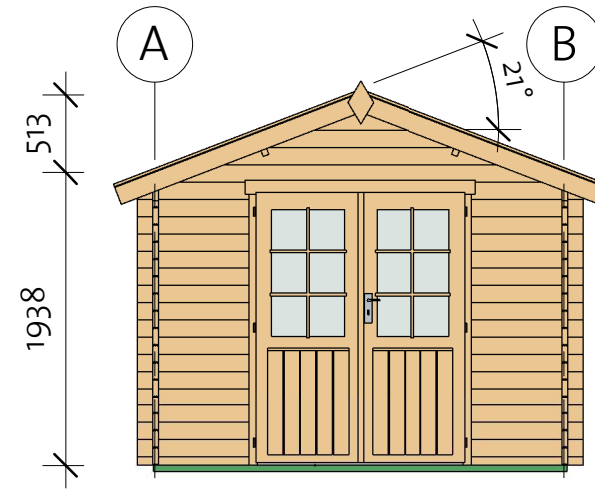

Zion 40 (275x380)

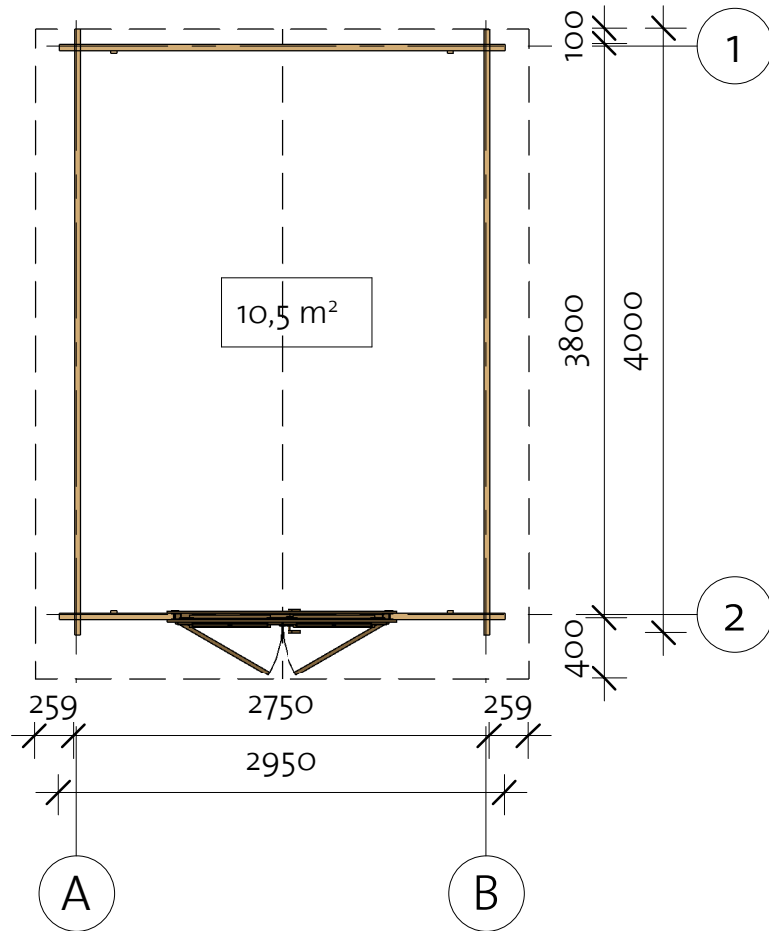

Zion 40 (275x380)

Foundation

Impregnated foundation beams				
Mark	Type	Profile	Count	Length
IFB	IFB 70x40		8	2740

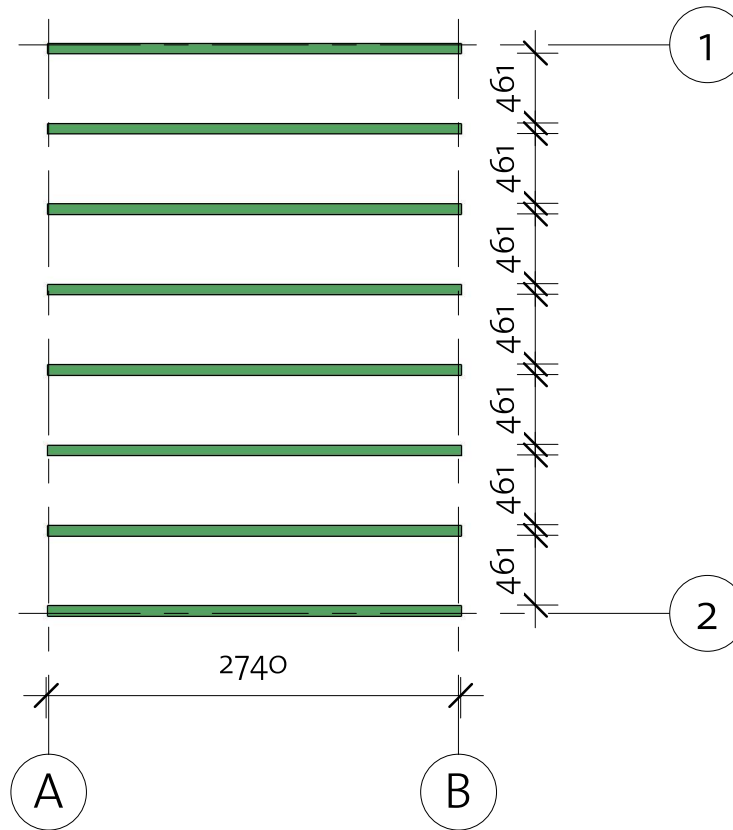



Zion 40 (275x380)

Floor Plan

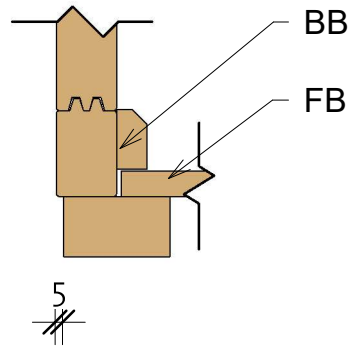
① Baseboard



Floor Schedule				
Mark	Type	Profile	Count	Length
FB	FB 17x114		24	3714
BB1	BB 20x40		2	2750
BB2	BB 20x40		2	3800

92007301_200730

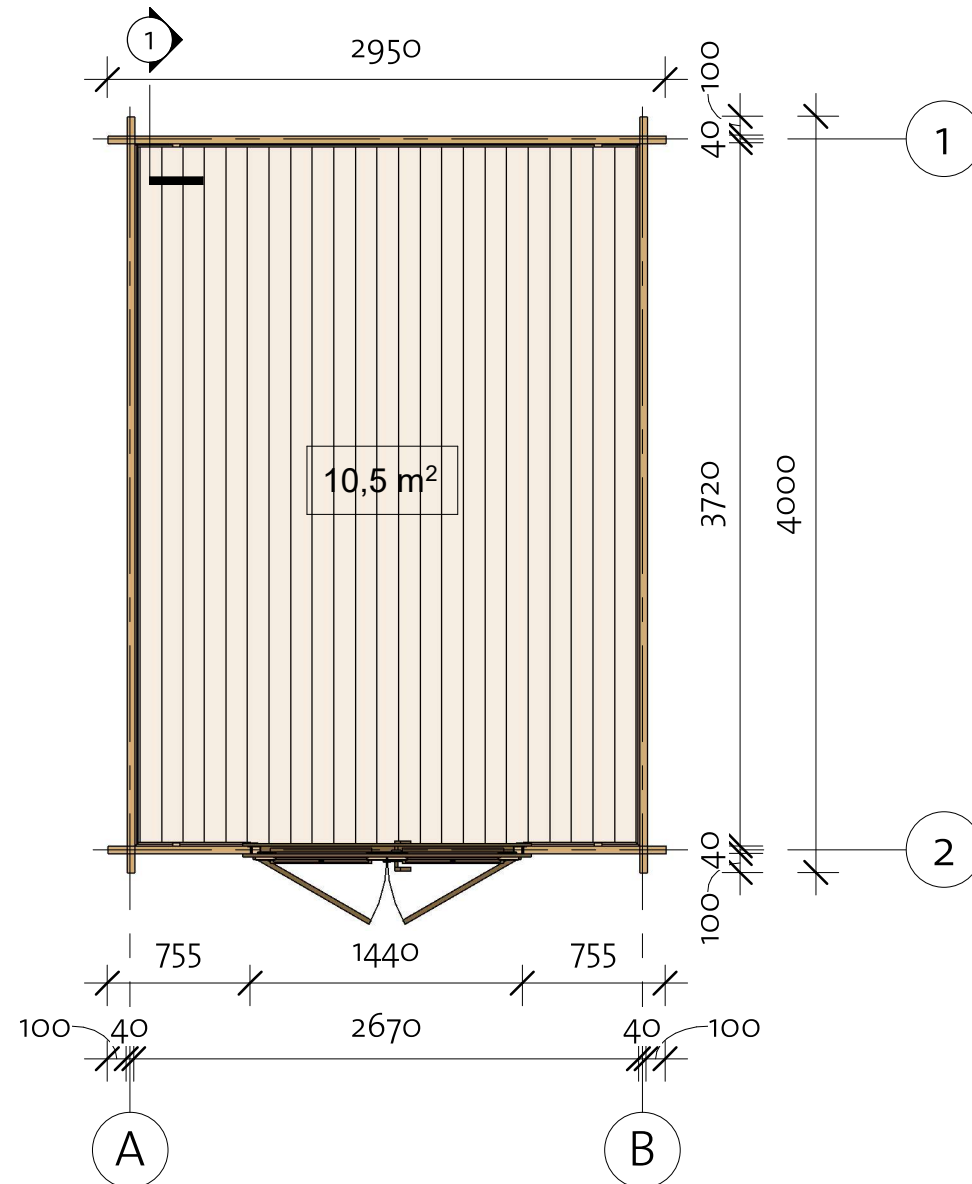

Zion 40 (275x380)

Wall 1

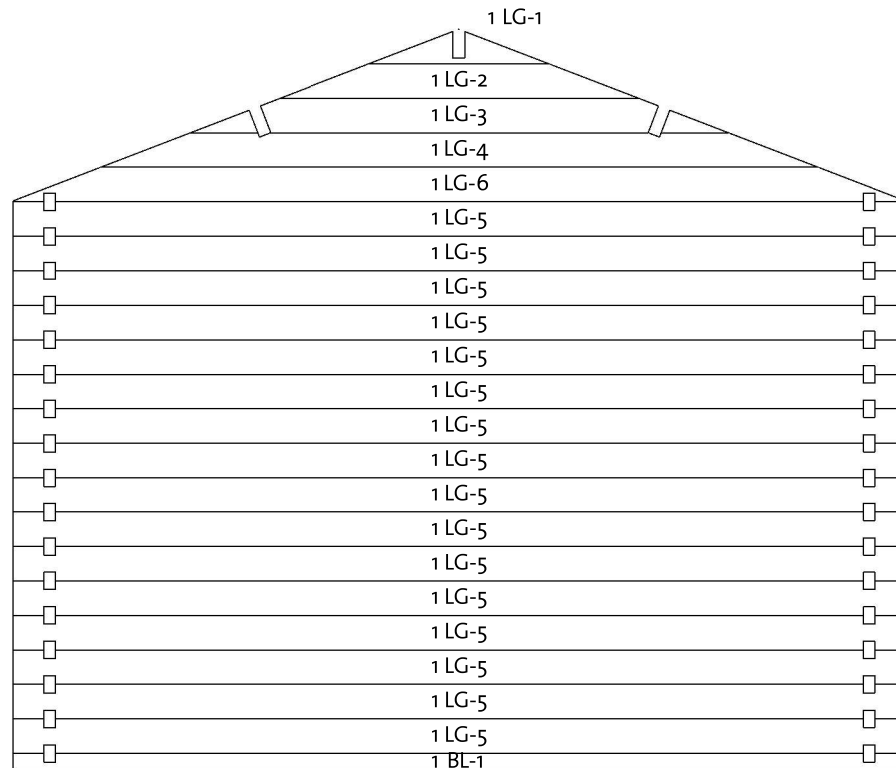
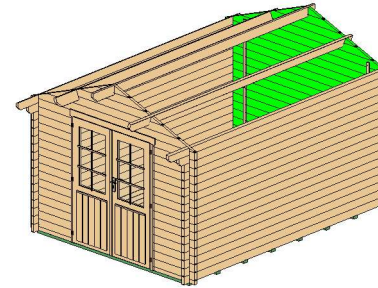

Wall 1			
Mark	Profile	Count	Cut Length

1BL-1	40x57	1	2950
1LG-1 *	40x114	1	594
1LG-2 *	40x114	1	1187
1LG-3 *	40x114	1	1780
1LG-4 *	40x114	1	2373
1LG-5	40x114	16	2950
1LG-6 *	40x114	1	2950

* Gable - delivered premounted

Log Profile Wall 1	
Profile	Profile

40x57	
40x114	

Zion 40 (275x380)

Wall 2

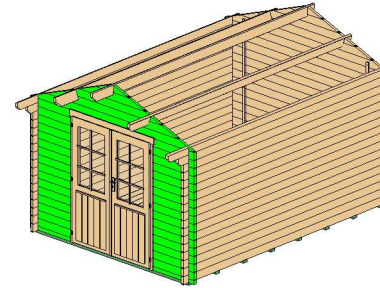

Wall 2			
Mark	Profile	Count	Cut Length

2BL-1	40x57	2	755
2LG-1 *	40x114	1	594
2LG-2	40x114	32	755
2LG-3 *	40x114	1	1187
2LG-4 *	40x114	1	1780
2LG-5 *	40x114	1	2373
2LG-6 *	40x114	1	2950

* Gable - delivered premounted

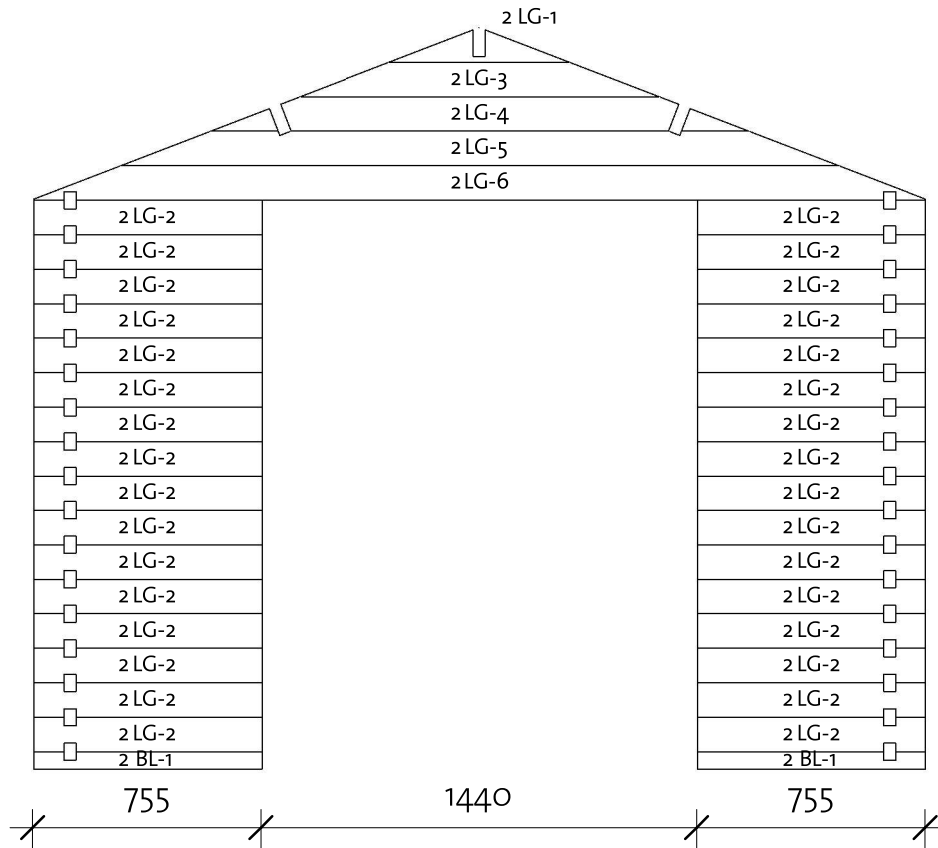

Log Profile Wall 2	
Profile	Profile

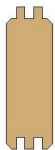
40x57	
40x114	

Zion 40 (275x380)

Wall A

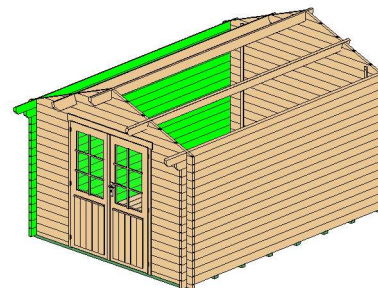

Wall A			
Mark	Profile	Count	Cut Length

ALG-1	40X114	15	4000
ALG-2	40X114	1	4100
ATL-1	40X114	1	4300

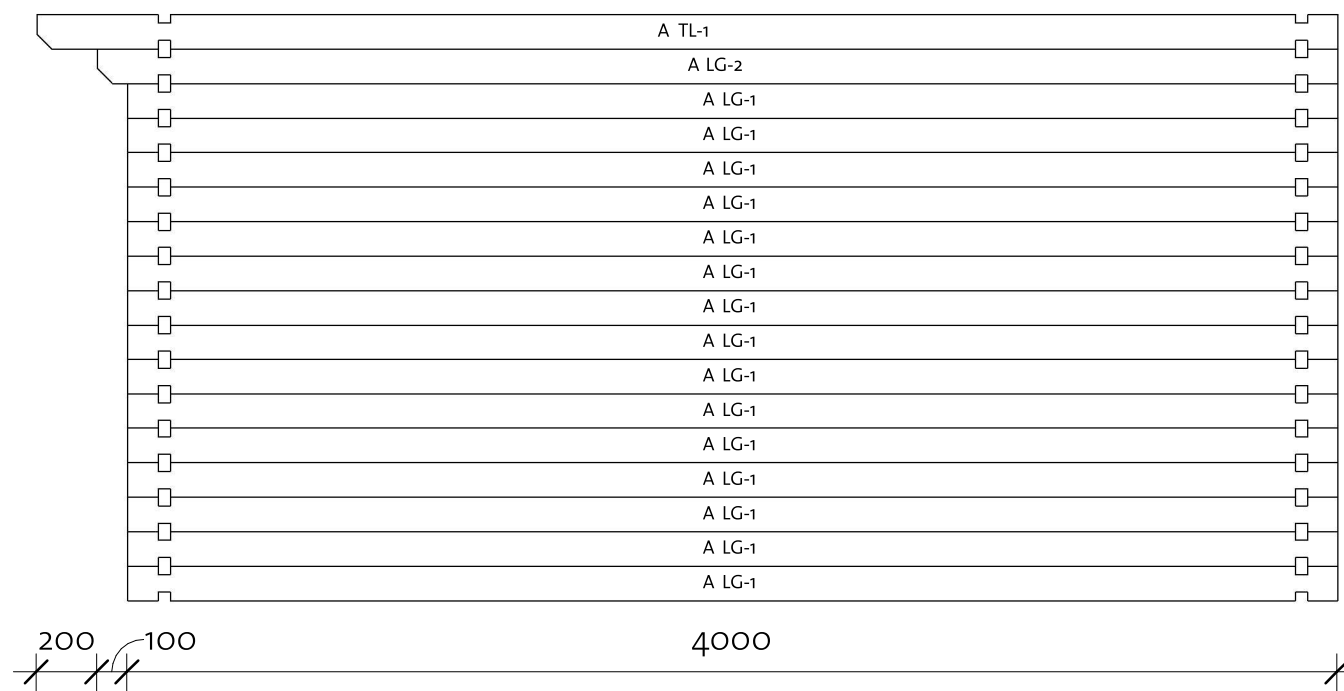

Log Profile Wall A	
Profile	Profile

40X114	
40X114	

Zion 40 (275x380)

Wall B

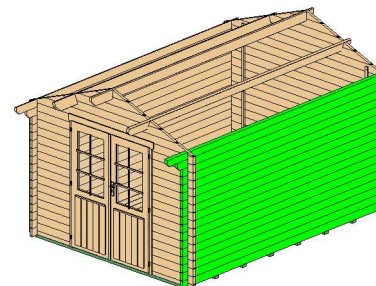

Wall B			
Mark	Profile	Count	Cut Length

BLG-1	40X114	15	4000
BLG-2	40X114	1	4100
BTL-1	40X114	1	4300

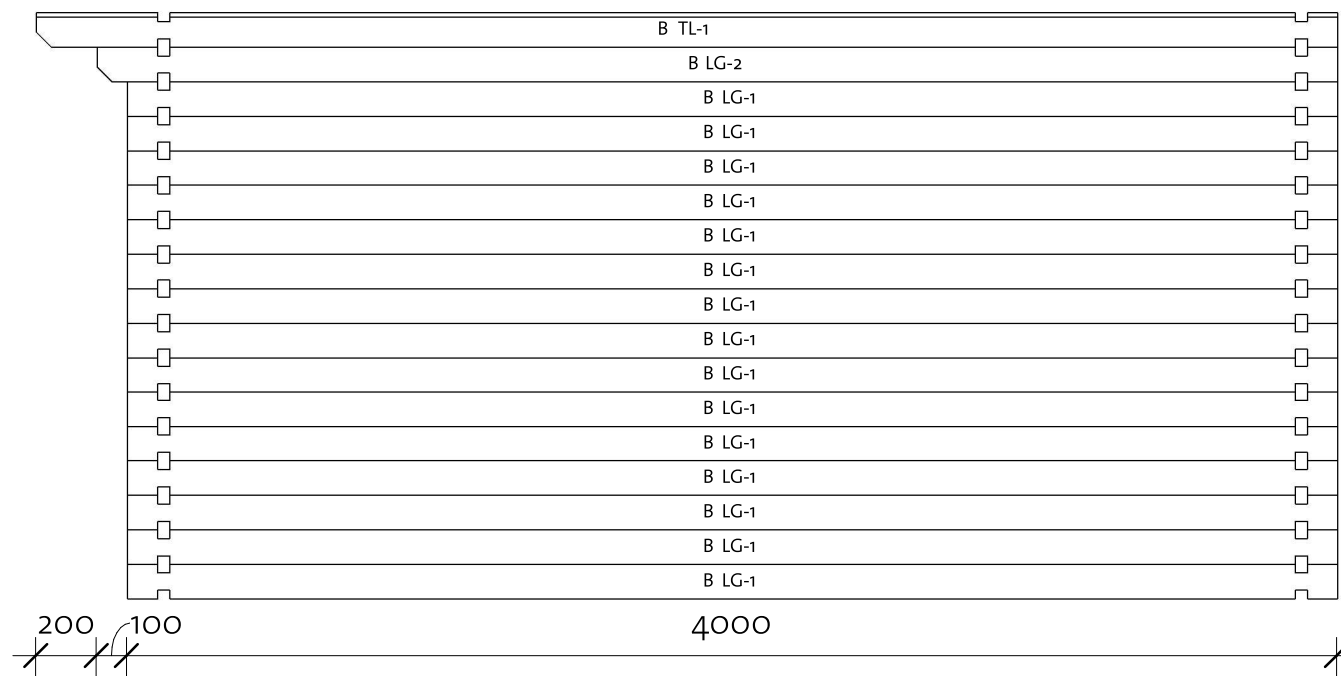





Log Profile Wall B	
Profile	Profile

40X114	
40X114	

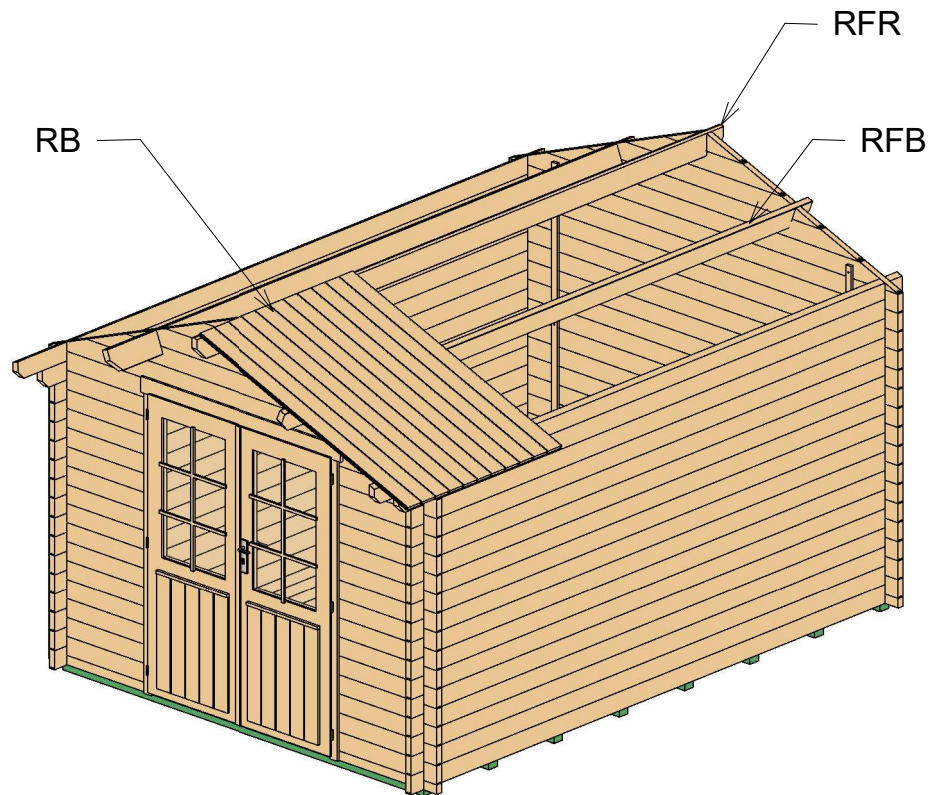
Zion 40 (275x380)

Roof 1



Roof				
Mark	Type	Profile	Count	Length
RFR	Ridge 40x143		1	4300
RFB	Beam 40x143		2	4300
RB	17x114		78	1697

Zion 40 (275x380)

Roof 2

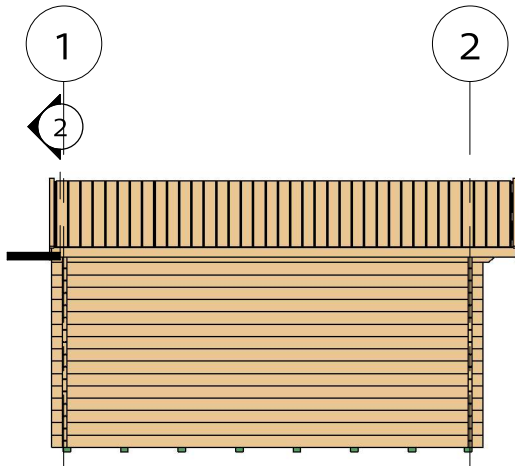

② Facia

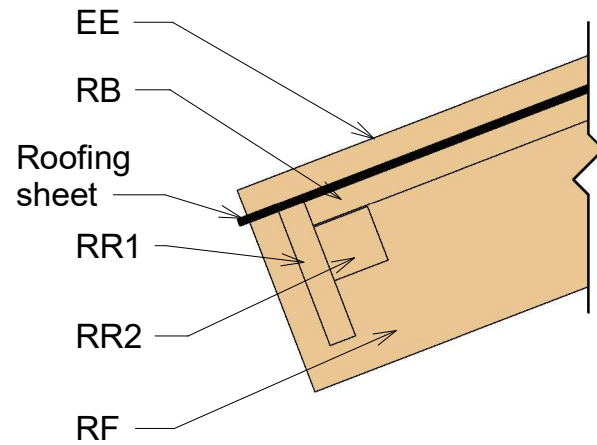

③ Roof Reinforcement

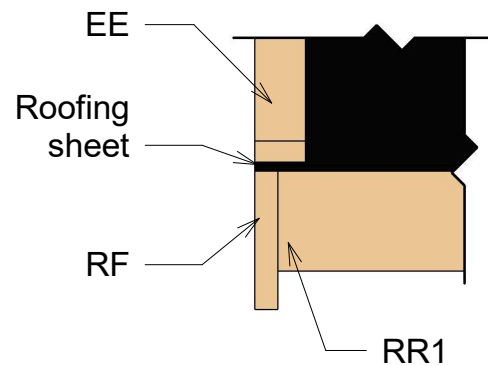
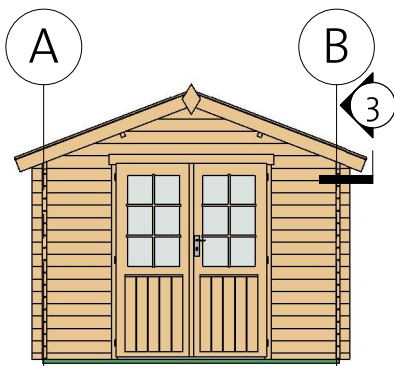

Fascia Schedule				
Mark	Type	Profile	Count	Length
EE	Eave Edging 18x40		4	1742
RF	Roof Fascia 18x120		4	1742
RR1	Roof reinforcement 18x95		2	4300
RR2	Roof reinforcement 38x38		2	4300

Zion 40 (275x380)

Extras

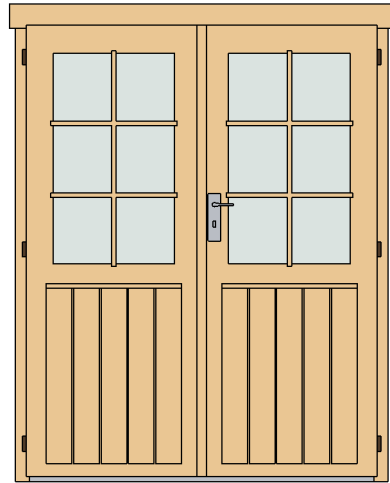

Door Schedule				
Mark	Type	Width	Height	Count
CDD12R	Classic double door 12 right	1425	1835	1
DCB6	Door Crossbar 6	--	--	2

Fasteners & Extras		
Name	Type	Count

Hitblock	300-400 mm	
Screws	5,0 x 70	10
Bolts	M8 x 70	12
Screws	6,0 x 140	35
Nails	1,4 x 40	35
Screws	4,0 x 40	560

Model	Count	Length
-------	-------	--------

Windboard 18x40	4	2200
-----------------	---	------

Family	Count
--------	-------



Romb	2
------	---







Zion 40 (275x380)

List of all items 1

Roof

Mark	Type	Profile	Count	Length
RFR	Ridge 40x143		1	4300
RFB	Beam 40x143		2	4300
RB	17x114		78	1697

Fascia Schedule

Mark	Type	Profile	Count	Length
EE	Eave Edging 18x40		4	1742
RF	Roof Fascia 18x120		4	1742
RR1	Roof reinforcement 18x95		2	4300
RR2	Roof reinforcement 38x38		2	4300

Floor Schedule

Mark	Type	Profile	Count	Length
FB	FB 17x114		24	3714

Impregnated foundation beams

Mark	Type	Profile	Count	Length
IFB	IFB 70x40		8	2740

BB1	BB 20x40		2	2750
BB2	BB 20x40		2	3800

Zion 40 (275x380)

List of all items 2

Wall 1			
Mark	Profile	Count	Cut Length

1BL-1	40X57	1	2950
1LG-1 *	40X114	1	594
1LG-2*	40X114	1	1187
1LG-3*	40X114	1	1780
1LG-4*	40X114	1	2373
1LG-5	40X114	16	2950
1LG-6*	40X114	1	2950

Wall 2			
Mark	Profile	Count	Cut Length

2BL-1	40X57	2	755
2LG-1 *	40X114	1	594
2LG-2	40X114	32	755
2LG-3*	40X114	1	1187
2LG-4*	40X114	1	1780
2LG-5*	40X114	1	2373
2LG-6*	40X114	1	2950

* Gable - delivered premounted



Wall A			
Mark	Profile	Count	Cut Length

ALG-1	40X114	15	4000
ALG-2	40X114	1	4100
ATL-1	40X114	1	4300

Wall B			
Mark	Profile	Count	Cut Length

BLG-1	40X114	15	4000
BLG-2	40X114	1	4100
BTL-1	40X114	1	4300

Log Profiles	
Profile	Profile

40X57	
40X114	

Log Profiles	
Profile	Profile

40X114	
--------	---